



# Welcome

## **We are a family-run supplier dealing almost exclusively with independent merchants.**

We know how you work, the challenges you face in a highly competitive market, and what you need to make your business successful.

Our external sales team have over 140 years' experience working in the industry (over 100 years of it at John George and Henry Shaw).

They provide services to suit you – advice on ranging, product knowledge support and help with merchandising and displays. Some of our customers class them as an integral part of their team and this is something of which we are extremely proud.

Since the reunion of John George and Henry Shaw in February 2021, our five depots make us ideally placed to deliver top level service on our own fleet of vehicles with our own drivers. Our drivers get to know where you are and how you work, which helps to create a smooth delivery process.

Our office based teams are on hand from 8.30 until 5pm, Monday to Friday, to answer questions and help with orders; with our website providing pricing and account information, as well as weekend ordering facilities.

**If you would like to discuss our services, please call one of our area representatives now.**

*M. Lambert*



# We're Your Specialists In...

**We supply over 2,000 outlets throughout the U.K. with over 9,000 product lines in key areas**

These areas include a whole range of specialist fixings, ironmongery, sealants and other products - all the things you need to meet the varied demands of your customers.



## Fixings & fasteners

Including nails, screws, bolts and masonry anchors, in both boxed and prepacked



## Ironmongery

Both boxed and prepacked



## Fencing products

Including netting, mesh, stock and security fencing and accessories for wire and timber fencing



## Building products

Including builders metalwork, damp proofing products, brickwork accessories, sealants and adhesives







# Your Logo Our Product

We can brand our products with your logo to help grow your business...

We offer an extensive product range. With large bulk boxes and cartons, as well as smaller prepacked buckets, bags and clams. Many prepacked products are available branded with your own corporate name and logo.



If you would like to discuss this service, please give us a call.



JOHN GEORGE

0118 941 1234



HENRY SHAW

0121 772 5561

# Order Online

## 1 Login

If you don't already have a web account with us you can apply for one online.

## 2 Shop

Choose from over 7000 products across our range - fixings through to fencing!

## 3 Checkout

Your order is placed and we email you an acknowledgement for your records.

## 4 Account

Check your account online to view orders, current prices and obtain copy invoices!



Place your order now at [johngeorge.co.uk](http://johngeorge.co.uk) or [henryshaw.co.uk](http://henryshaw.co.uk)

# Delivery

**In 1921 we started delivering to customers using our own lorry and since then our fleet has grown.**

Over the years we have found that owning and running our own delivery vehicles means that we can be flexible and offer better customer service.

Our 5 depots make us ideally placed to cover the whole of the UK. Our overnight transhipments ensure stock can be moved between the depots and demands met across our customer base.

We are now delivering to over 2,000 customers a range of over 9,000 products. We aim to provide over 99% stock availability and next-day delivery where possible, holding six months' of stock for reliable service provision to our customers.





# Contact Us

Our office based teams are on hand from **8.30am until 5pm, Monday to Friday**, to answer questions and help with orders; with our websites providing pricing and account information, as well as weekend ordering facilities.

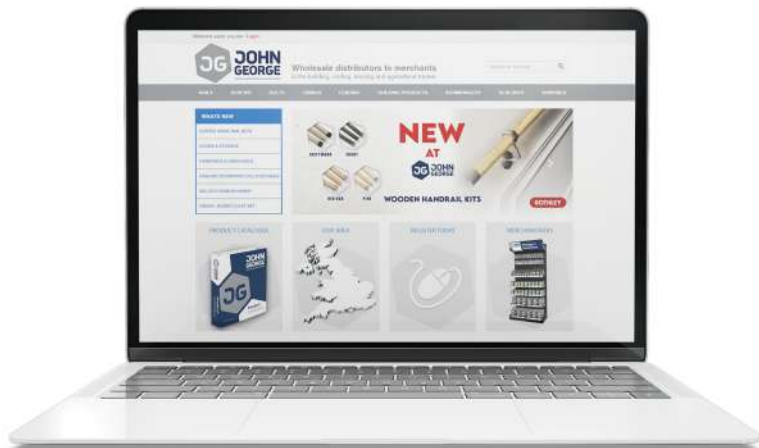

**JOHN GEORGE**



**0118 941 1234**

[sales@johngeorge.co.uk](mailto:sales@johngeorge.co.uk)

**HENRY SHAW**



**0121 772 5561**

[sales@henryshaw.co.uk](mailto:sales@henryshaw.co.uk)



**NAILS**

**10-60**

**SCREWS**

**61-82**

**BOLTS**

**83-93**

**FIXINGS**

**94-101**

**FENCING**

**102-111**

**BUILDING PRODUCTS**

**112-125**

**IRONMONGERY**

**126-165**

**SEALANTS**

**166-178**

**SUNDRIES**

**179-186**

## BOXED NAILS

### COLLATED NAILS

- 10 Exocet Strip Nails  
Exocet Brads
- 13 Paslode Strip Nails  
Paslode Brads  
Paslode Twist Nails

### FERROUS NAILS

- 14 Round Wire Nails  
Oval Brad Nails  
Lost Head Nails
- 15 Annular Ring Nails  
Panel Pins  
Veneer Pins
- 16 Cut Clasp Nails  
Cut Floor Brads  
Square Twist Nails  
Drive Screws
- 17 Clout Nails  
ELH Clout Nails  
Jagged Shank Nails  
Insulation Nails  
Springhead Nails
- 18 Cut Point Staples  
Barbed Staples  
Presser Point Staples

### MASONRY NAILS

- 18 Countersunk Masonry Nails  
Flat Masonry Nails  
Washed Masonry Nails

### NON FERROUS NAILS

- 19 Stainless Steel Round Wire Nails  
Stainless Steel Annular Ring Clout Nails  
Stainless Steel Lost Head Nails  
Stainless Steel Panel Pins
- 20 Aluminium Clout Nails  
Aluminium Annular Ring Nails  
Aluminium Tile Pegs
- 21 Copper Clout Nails  
Copper Annular Ring Nails  
Silicon Bronze Annular Ring Nails

### FASCIA NAILS & PINS

- 22 Fascia Nails  
Fascia Pins  
Cladding Pins

### PREPACKED NAILS

#### CLAMS & TUBS

- 24 Clams & Tubs - John George Brand
- 33 Clams & Tubs - Your Own Brand

#### BAGGED

- 44 Bagged - John George Brand
- 51 Bagged - Your Own Brand

#### 20KG TUBS

- 58 20kg Tubs - Your Own Brand

#### CLAMPAQ

- 59 Nails, Staples & Pins
- 60 Masonry Nails  
Fascia Nails & Pins  
Cut Tacks  
Drawing Pins  
Upholstery Nails  
Gimp Pins  
Escutcheon Pins  
Cable Clips  
Picture Hooks & Pins

## BOXED SCREWS

### SUPER DRIVE

- 61 Super Drive Professional Woodscrews

### IMPACT WOODSCREWS

- 66 Impact Woodscrews

### TWINTHREAD WOODSCREWS

- 67 Countersunk Twinthread Screws  
Round Head Twinthread Screws

### UNIVERSAL SCREWS

- 68 Universal Screws - ZYP  
Universal Screws - Stainless Steel

### DRYWALL SCREWS

- 69 Drywall - BZP  
Drywall - Black Phosphate
- 70 Collated Drywall  
Self Drilling Drywall  
Wafer Head Drywall

### DECKING SCREWS

- 71 Decking - Green Organic  
Decking - Stainless Steel  
Screw Metric Conversions  
Screw Gauge Equivalents

### TIMBERFAST

- 74 Timberfast - Hex Head  
Timberfast - Flush Head

### COACH SCREWS

- 75 Coach Screws - BZP  
Coach Screws - Stainless Steel

### BRASS SCREWS

- 76 Self Colour Slotted Brass Screws  
Chrome Plated Slotted Brass Screws

### SELF TAPPERS

- 77 Recessed Self Tapping - Pan Head  
Recessed Self Tapping - Countersunk

### SPECIALIST SCREWS

- 78 Mirror Screws  
Anti-Vandal Security Screws  
Tongue-Tite Screws  
Carcass Screws

### SCREW CUPS, COVERS & PLUGS

- 78 Surface Pattern Screw Cups  
Recessed Pattern Screw Cups
- 79 Screw Covers  
Dome Tops  
Wall Plugs

### PREPACKED SCREWS

#### CLAMPAQ

- 80 Super Drive Professional Woodscrews  
Countersunk Twinthread Screws
- 81 Round Head Twinthread Screws  
Universal Screws - ZYP  
Universal Screws - Stainless Steel
- 82 Self Colour Slotted Brass Screws  
Chrome Plated Slotted Brass Screws  
Mirror Screws  
Anti-Vandal Security Screws  
Surface Pattern Screw Cups  
Screw Covers

## BOXED BOLTS

### BOXED BOLTS

- 83 Cup Square Hex Carriage Bolts & Nuts - BZP  
Cup Square Bolts - Stainless Steel
- 84 Hex Set Screws  
Hex Round Bolts
- 85 Mushroom Head Roofing Bolts  
Gutter Bolts  
Hook Bolts

### STUDDING

- 86 Studding - Mild Steel BZP  
Studding - HT Steel BZP  
Studding - Stainless Steel

### MACHINE SCREWS

- 86 Pan Head Machine Screws  
Countersunk Machine Screws

### NUTS & CONNECTORS

- 87 Hex Full Nuts  
Hex Nylon Insert Nuts  
Wing Nuts  
Timber Connectors  
Studding Connectors

### STEEL WASHERS & PLASTIC WASHERS

- 88 Form A Washers  
Form C Washers  
Mudguard Washers  
Square Plate Washers
- 89 Diamond Curved Washers  
Shakeproof Washers  
Spring Washers  
Plastic Roofing Washers  
Plastic Top Hats  
Plastic Sealing Washers  
Plastic Sealing Covers

### PREPACKED BOLTS

#### BAGGED

- 90 Coach Screws, Bolts & Nuts
- 91 Nuts  
Steel Washers  
Plastic Washers  
Connectors  
Nuts & Washers

## BOXED FIXINGS

### THUNDERBOLTS

- 94 Hex Head Thunderbolts
- Hex Flange Head Thunderbolts
- Eye Thunderbolts
- Hook Thunderbolts
- Countersunk Torx Head Thunderbolts

### HEAVY/MEDIUM DUTY FIXINGS

- 95 Nut Type Sleeve Anchors
- Through Bolts
- Wallbolts/Sleeve Anchors

### LIGHT DUTY FIXINGS

- 96 Hammer Fixings
- Frame Fixings

### CHEMICAL INJECTION

- 96 Chemical Injection Polyester Resin
- Spare Mixer Nozzles
- Resin Studs

### MASONRY SCREWS

- 97 Impact Masonry Screws
- Light Duty Masonry Screws

### SPECIALIST FIXINGS

- 98 Express Nails
- Rimless Nylon Plugs
- Metal Cavity Anchors
- Self Drilling Cavity Fixings
- Spring Toggles
- Gripit Plasterboard Fixings

### TEK SCREWS

- 99 Tek Screw Hex Head
- Stitching Screw
- Tek Screw Sheet to Timber
- Tek Screw Timber to Steel
- Bonded Washer

### PREPACKED FIXINGS

#### BAGGED

- 100 Thunderbolts
- Heavy/Medium Duty Fixings
- Light Duty Fixings
- 101 Impact Masonry Screws
- Specialist Fixings

## FENCING

### ROLLS

- 102 Wire Netting
- 103 Welded Mesh
- Security Fencing
- Stock Fence
- Chain Link Fencing

### PANELS

- 104 Welded Mesh Panels
- Handy Mesh Panels

### WIRE

- 104 Galvanised Wire
- Barbed Wire
- Razor Wire
- Strand Wire
- Line Wire
- Tying Wire

### FENCE POST SUPPORTS

- 105 Fence Post Supports
- Bolt Down Fence Post Supports
- Fence Post Repair Supports
- Concrete In Supports
- Fence Post Driving Tool
- Fence Post Extenders
- Handrail Connectors

### BARRIER FENCING

- 106 PVC Barrier Fencing
- Fencing Pins

### TIMBER FENCING ACCESSORIES

- 107 Arris Rail Repair Brackets
- Cant Rail Repair Brackets
- Panel Clips
- Trellis Clips
- Panel Security Brackets
- Knee Rail Straps
- Gravel Board Cleats
- Gravel Board Brackets

### WIRE JOINERS, CLIPS & PLIERS

- 108 Gripple Plus Wire Joiners
- Netting Clips
- FP222 Rapid Fencing Pliers
- Hog Rings & CT22 Pliers
- CL35 Netting Clips
- Netting Fasteners & Pliers

### STRAINING FENCE POSTS

- 109 Corner Straining Fence Post
- End Straining Fence Post
- 2 Way Straining Fence Post
- Angle Iron Stakes
- Bent Over Arms
- Barbed Wire Angle Bracket
- Stretcher Bars

### FENCING ACCESSORIES

- 110 Angle Cleats
- Loop Adapters
- Ratchet Winders
- Wire Strainers
- Barrel Strainers
- Straining Eye Bolts

### GARDEN PRODUCTS

- 110 Wire Netting
- 111 Welded Mesh
- Handy Mesh Panels
- Chain Link Fencing
- Border Fence
- Garden Fence
- Barbed Wire
- Fencing Stakes
- Ground Control
- Weed Control

## BUILDING PRODUCTS

### BUILDERS METALWORK

- 112 Timber to Timber Joist Hangers
- Build In Joist Hangers
- Anchor Straps
- 113 Angle Brackets
- Truss Clips
- Herringbone Struts
- Fixing Bands
- Framing Anchors
- Nail Plates
- Gallows Brackets

### WALL & FRAME TIES

- 114 Wall Ties & Insulation Clips
- Timber Frame Ties
- Wall Starter Kits
- Starter Ties
- 115 Door Frame Cramps
- Screw in Frame Ties
- Water Bars

### CRACK STITCHING

- 115 Crack Stitching Kits
- Grout for Crack Stitching
- Helical Bars for Crack Stitching

### PLASTERING & RENDERING

- 116 Angle/Corner Beads
- Mini Mesh
- Perforated Thin Coat Angle Beads
- Arch Beads
- Stop Beads
- Perforated Thin Coat Stop Beads
- External Render Stop Beads
- 117 Expanded Metal Lathing (EML)
- Expanded Brick Reinforcement
- Plasters Scrim Tape
- Render Mesh

### BUCKETS

- 117 Flexi-Tub Buckets
- Rigid Builders Buckets

### DPC, DPM, CAVITY CLOSERS

- 118 DPC
- Cavity Closers
- Polythene Film
- Expansion Joint Filler

### AIRBRICKS & VENTS

- 119 Combination Airbrick
- Telescopic Underfloor Vents

### WEEP VENTS & ACCESS PANELS

- 120 Weep Vents
- Peep Weep Vents
- Refurbishment Weep Vents
- 121 Access Panels

### INSECT MESH & BIRD SPIKES

- 121 Insect Mesh
- Soffit Vent Mesh
- Bird Spikes

### PLASTIC PRODUCTS

- 121 Rubble Sacks
- Pallet Wrap

### ROOFING FELT

- 122 Green Mineral Felt
- Roofing Felt
- Slaters Felt

### PROTECTIVE SHEETING, BAGS & SASH CORD

- 122 Debris Netting
- Hessian Frost Protection Sheet
- Sandbags
- Kindling Net Bags
- 123 Tarpaulin
- Sash Cord

### PACKERS & WEDGES

- 123 Glazing, Frame, Wedge Packers

### ROOFING FIXINGS

- 124 Helical Thread Fixings
- Ridge Nail & Screw Sets
- Slate Straps & Hooks
- UPVC Hinged Washers
- Copper Disc Rivets
- 125 Lead Dome Sets
- Lead Flashing Fixing Clips

### ROOFING PRODUCTS

- 125 Wire Balloons
- Snowguards & Brackets
- Hip Irons
- EDPM Lead Replacement
- Soakers
- Soft Copper Wire



## IRONMONGERY

### BUTT HINGES

- 126** 551 Butt Hinge  
 1838 Light Butt Hinge  
 451 Strong Butt Hinge  
 451/S High Security Butt Hinge  
 899 Extra Strong Butt Hinge
- 127** 1840 Loose Pin Butt Hinge  
 200 Cast Iron Butt Hinge  
 466 Rising Butt Hinge  
 457 Lift Off Butt Hinge

### SPECIALIST HINGES

- 128** 104 Hurlinge  
 105 Flush Hinge  
 1951 Stormproof Hinge  
 488 Parliament Hinge  
 Double Action Spring Hinge  
 400 Backflap Hinge  
 101 Piano Hinge

### BRASS HINGES

- 129** 416 Brass Butt Hinge  
 417 DSW Brass Butt Hinge  
 418 DSW Brass Butt Hinge  
 1951 Brass Stormproof Hinge  
 488 Brass Parliament Hinge

### HEAVY HINGES

- 129** 499 Heavy Reversible Hinge  
 499C Cups for Heavy Reversible Hinge

### TEE & STRAP HINGES

- 130** 121A Light Tee Hinge  
 121 Medium Tee Hinge  
 868 Weighty Scotch Tee Hinge  
 910 Tee Hinge Brass Pin  
 910 Heavy Tee Hinge  
 950 Strap Hinge

### HOOKS & BANDS

- 131** 1055 Straight Hook & Band  
 1056 Cranked Hook & Band  
 1057 Adjustable Hook & Band  
 1056H Hook on Plate  
 1058 Curved Hinge Rail Set

### BOLTS

- 132** 923A Straight Tower Bolt  
 923N Necked Tower Bolt  
 2A Brenton Padbolt  
 1A Heavy Brenton Padbolt  
 4A Oval Padbolt  
 60MT Monkey Tail Bolt
- 133** 60BH Bow Handle Bolt  
 66 Chain Bolt  
 68 Foot Operated Bolt  
 1260 Garage Door Bolt  
 Straight Barrel Bolt  
 Necked Barrel Bolt

### LATCHES

- 134** 20 Light Suffolk Latch  
 20/5 Heavy Suffolk Latch  
 20/5L Long Thumb Suffolk Latch  
 1136 Plain Ring Gate Latch  
 1141 Twisted Ring Gate Latch  
 1819 Auto Gate Latch  
 1822 Strong Auto Gate Latch

### HASP & STAPLES

- 135** 610 Wire Hasp & Staple  
 617 Safety Hasp & Staple  
 149H Heavy Hasp & Staple  
 146 Heavy Vertical Hasp & Staple  
 147 Heavy Swivel Locking Bar

### CABIN HOOKS

- 135** 1261 Wire Cabin Hook  
 37 Cast Cabin Hook

### DOOR CLOSERS/HOLDERS

- 136** 500 Gate Spring  
 1470 Concealed Door Closer  
 Perko R2 Concealed Door Closer  
 Dorma TS68 Door Closer  
 Garage Door Holders

### LOCK LATCHES

- 136** Mortice Latches  
 Rim Locks  
 Rim Knobs
- 137** GatePro Long Throw Locks

### WINDOW FURNITURE

- 138** 500 Casement Stay  
 504 Casement Fastener  
 521 Casement Fastener  
 561 Casement Stay  
 A1 Sash Fastener  
 655 Quadrant Sash Fastener  
 674 Fitch Fastener

### FIELDGATE

- 139** Fieldgate Hinge Sets  
**140** Spring Fastener Components  
 Spring Fastener Sets  
 Double Strap Hinges  
 Rising Hinges  
 Double Gate Fastener Sets
- 141** Adjustable Eyes  
 Adjustable Eye U Brackets  
 Adjustable Bottom Gate Fittings  
 Hook to Bolt  
 Hook to Drive  
 Hook for Brickwork  
 Hook on Plate
- 142** Heavy Self Locking Gate Latch  
 Gate Latch Strikers  
 Catch for Centrally Closing Gate  
 Cast Gravity Catch to Concrete In  
 Spring Loaded Bolt  
 Gate Staple Catch to Drive  
 Kickover Gate Latch  
 Throwover Gate Loop

- 143** Safety Hook & Eye  
 Slip Rail Bracket Set  
 Gate Hooks to Weld  
 Gate Eyes to Weld

### HEAVY CHAIN ACCESSORIES

- 143** 510 Manger Ring on Eye  
 511 Hook on Plate  
 512 Staple on Plate  
 513 Manger Ring on Plate

### FURNITURE CONSTRUCTION & REPAIR

- 144** 315 Stretcher Plate  
 318 Tee Plate  
 319 Corner Brace  
 324 Corner Plate  
 325 Mending Plate  
 55 Cupboard Button

### HANDLES & HANDRAIL BRACKETS

- 145** 236 Handrail Bracket  
 1100 Hotbed Handle  
 246 Chest Handle

### PULLEYS & HOOKS

- 145** 202S Secret Axle Pulley  
 GP039 Single Screw Pulley  
 GP042 Double Screw Pulley  
 GP261 Line Pulley  
 GP260 Hooked Line Pulley  
 G2003/4 Cleat Hooks

### TWINSLOT SHELVING

- 146** Twinslot Uprights  
 Twinslot Brackets  
 Twinslot Flexible Book Ends

### FIXED SHELVING

- 147** Mitred Brackets  
 Cantilever Brackets  
 240 London Pattern Shelf Brackets  
 247 Fluted Angle Brackets  
 Ornamental Scroll Brackets  
 422 Stay Shelf Brackets

### WEATHERBARS & DEFLECTORS

- 148** Threshex Sills  
 Kleertred 20 Sills  
 Macclex 15/2 Sills  
 Macclex Lowline Sills  
 Weatherbar Kit (MWK 20)  
 Weatherten Bars  
 Weatherten Lowline Bars  
 DFR20 Rain Deflector  
 Expelex Deflector  
 ERD Rain Deflector  
 Carex Garage Door Seal  
 Garin Garage Door Seal

### DOOR SURROUNDS & SEALS

- 150** Standard Door Surround  
 Flex N Seal Set  
 QDS Door Set  
 Windor PVC Door Surround  
 PVC Pile Weather Set  
 Bladex Draught Excluder  
 Double Door Centre Seal

### JOINERY SEALS

- 151** E Strip  
 P Strip  
 V Strip  
 Aquatex A10 Weatherseal  
 Self Adhesive Foam  
 Self Adhesive Pile  
 Threshold Sealing Bar

### LETTERPLATES & ACCESSORIES

- 152** Aluminium Letterplate Seals  
 PVC Letterplate Seals  
 Brush Strips  
 Glazing Film  
 Under Door Draught Excluder  
 Radiator Foil  
 Insulating Tap Cover

### TUBE/RAIL & ACCESSORIES

- 153** Tube/Rail  
 Tube Accessories  
 Curtain Rail Accessories

### KITCHEN WORKTOP TRIMS

- 154** Corner Joint Worktop Trims  
 Straight Joint Worktop Trims  
 End Cap Worktop Trims

### HANDRAILS & GRAB RAILS

- 154** Handrail Kits  
 Grab Rails

### CABINET FITTINGS

- 155** Concealed Hinges  
 Magnetic Catch  
 Mortice Roller Catch  
 Bales Catch  
 Double Roller Catch  
 Tutch Latch  
 Knockdown Joint  
 Modesty Block  
 Door Stop  
 Worktop Connecting Bolts

### FLOORING TRIMS

- 156** Aluminium Flooring Trims

### METAL SHEETS

- 156** Aluminium Sheets  
 Steel Sheets

### PROFILES

- 157** PVC Profiles  
 Steel Profiles  
 Aluminium Profiles

### INTUMESCENT PRODUCTS

- 158** Intumescent Strips  
 Intumescent Door Packs  
 Dropdown Seals  
 Intumescent Letterboxes  
**159** Intumescent Air Transfer Vents  
 Intumescent Grilles  
 Intumescent Hinge Pads  
 Intumescent Sheets  
 Intumescent Lock Kits  
 Intumescent Packers

### HOOKS & HANGERS

- 160** Light & Medium Hooks  
 Storage & Utility Hooks  
 Heavy Duty Storage Hooks  
 Bike Storage

### GATEPRO PREPACKED IRONMONGERY

- 161** Hinges  
**162** Bolts  
**163** Latches  
**164** Hasp & Staples  
 Cabin Hooks  
 Gate Springs/Kits  
 Rim Locks  
 Padlocks  
**165** Gravel Board Set  
 Fieldgate Catches & Bolt  
 Heavy Chain Accessories  
 Furniture Construction & Repair  
 Pulleys & Cleats

## SEALANTS

### PROFESSIONAL SEALANTS

- 166 Forever White  
Forever Clear  
200 Contractors LMA Silicone  
125 One Hour Caulk  
500 Bath & Sanitary Silicone  
450 Builders Silicone  
225 Industrial & Glazing Silicone

### SPECIALIST SEALANTS

- 167 Fire Mate Sealant  
Weather Mate Sealant  
Lead Mate Sealant

### DIY SEALANTS

- 168 Bath & Kitchen Sealant  
Roof & Gutter Sealant  
External Frame Sealant  
General Purpose Silicone  
Decorators Flexible Filler  
Sealant Guns

### CLEANERS & LUBRICANTS

- 168 Silicone Spray  
Wonder Wipes
- 169 Dual Purpose Foam Cleaner

### FOAMS

- 169 Gun Grade Expanding Foam  
Fire Foam B1  
Fire Foam B2  
No Waste Foam  
Fix & Fill Expanding Foam  
Pinkgrip Dryfix  
P45 Foam Gun

### GRAB ADHESIVES

- 170 EB25 Polymer Adhesive & Sealant  
PinkGrip  
Gun A Nail  
Instant Nails  
Sticks Like Sh\*t  
Multi-Stick  
Stixall  
Mirror Mate

### WOOD ADHESIVES

- 171 502 All Purpose Wood Adhesive  
D4 Wood Adhesive  
Polyurethane Wood Adhesive

### TILE ADHESIVES

- 171 701 Non Slip Tile Adhesive  
708 Self Level Floor Compound  
730 Powder Wall Tile Grout

### CONTACT ADHESIVES & SUPERGLUE

- 172 Stick 2 Spray Contact Adhesive  
Stick 2 All Purpose Contact Adhesive  
Mitre Fast Bonding Kit  
Stick 2 All Purpose Superglue

### TECHNICAL MORTARS

- 172 Jetcem Rapid Repair Cement  
Jetcem Premix Sand & Cement

### WINTER PRODUCTS

- 172 Screen De-icing Spray  
Screen Wash Concentrate

### MARKER SPRAY

- 172 Surveyline Marker Spray

### WOOD TREATMENTS

- 173 Creosote  
Creocote  
Triple Action Wood Treatment

### BUILDING PRODUCTS

- 174 201 Mortar Admix  
202 Integral Waterproofer  
203 Accelerator & Frostproof  
204 Evermix 3 in 1  
Opti-Mix Integral Waterproofer  
Opti-Mix Mortar Plasticiser  
501 PVA Bond  
503 SBR Bond
- 175 506 Contractors PVA Bond  
507 Rendagrip  
Febond True Grit  
208 Powder Mortar Tone

### LANDSCAPING PRODUCTS

- 175 401 Brick & Patio Cleaner  
402 Waterseal  
405 Path & Patio Seal

### FILLERS & DECORATOR SUNDRIES

- 176 Roll & Stroll Floor Protector  
Multi Purpose Wood Filler  
Two Part Wood Filler  
Turpentine Substitute  
White Spirit  
Boiled Linseed Oil  
One Strike Filler  
Dust Sheets

### TAPES

- 177 Mammoth Mega Tape  
Mammoth Aluminium Tape  
Masking Tape  
SOS Self Amalgamating Tape  
Self Adhesive Barrier Tape  
Non-Adhesive Barrier Tape  
Jointing Tape  
Warning Tape

### BITUMENS & ROOFING

- 178 Flashing Tape  
Evercyl Roof Repair  
Lead Mate Patination Oil  
901 Bitumen Paint  
903 Bitumen Trowel Mastic  
904 Roof Felt Adhesive  
905 All Weather Roof Coating  
907 Solar Reflective Paint  
908 DPM

## SUNDRIES

### CHAIN

- 179 Welded Chain  
Security Chain  
Plastic Chain  
Oval Chain
- 180 Twisted Curb Chain  
Single Jack Chain  
Clock Chain  
Cathedral Chain  
Genovese Chain  
Decorative Square Chain  
Knotted Chain  
Brass Ball Chain

### ROPE

- 181 Wire Rope  
Twisted Polypropylene Rope  
Woven Polypropylene Rope  
Nylon Interwoven Rope  
Elastic Rope  
Polyester Yacht Rope  
Sisal Rope  
Hemp Rope

### ACCESSORIES

- 182 Carbine Hooks  
Quick Links  
Dee Shackles  
Spring Hooks  
Wire Rope Grips  
Corrugated Fasteners  
Metal Dowels
  - 183 Cable Ties  
Screw Eyes  
Cup Hooks  
M Hooks  
Gate Hooks & Eyes  
Vine Eyes to Drive  
Vine Eyes to Screw
  - 184 Unbreakable Pencils
- ### JUBILEE CLIPS
- 184 Jubilee Clips - BZP  
Jubilee Clips - Stainless Steel  
Jubilee Clip Flexdriver  
Jubilee Clip Dispenser

### PREPACKED SUNDRIES

#### BAGGED

- 185 Wire Rope Grips  
Carbine Hooks  
Dee Shackles  
Thimbles  
Meat Hooks  
Quick Links  
Mending Links  
Trigger Hooks  
Straining Screws  
Jubilee Clips

#### CLAMPAQ

- 186 Hooks & Eyes

# WORK FAST WITH

# EXOCET

## COLLATED NAIL SYSTEM



**IDEAL FOR  
WOOD  
FRAMING  
FLOORING  
ROOFING**

**Quick, easy and a builder's essential - our Exocet nails have been around for over a decade.** Designed for use with ALL major 34° clipped head nail gun brands, the nails are collated with paper strip which is anti-jam, environmentally friendly and also helps keep the site tidy. A comprehensive range of different sizes, shanks and finishes ensures you can select the right Exocet for the job whether indoors or outdoors. With gas included, everything you need is all in one box - and it's easy to carry too.





### ANTI-JAM PAPER STRIP

You can complete your work quicker without having to stop to remove jammed paper.



### CLIPPED HEAD

Allows quick loading into the nail gun.



### SHARP POINT

For instant timber penetration and minimal disruption to the surface of the wood.



### GAS INCLUDED

No need to buy spare gas, everything you need is all within the box - apart from the nail gun.



### SMOOTH OR RINGED SHANK

Smooth shanks are ideal where a strong, lasting grip is not essential and you can benefit from a more economical option. Ringed shank nails have twice the withdrawal strength and so are needed for more hostile environments.

## FINISHES

### & CORROSION RESISTANCE

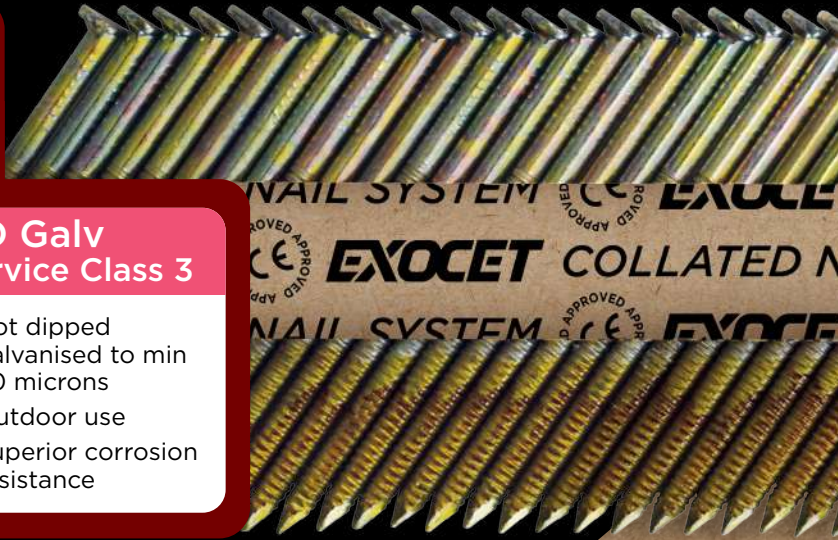

#### Bright Service Class 1

- Economical
- Indoor use
- Limited corrosion resistance

#### Exogalv Plus Service Class 2

- Electro-galvanised to min 12 microns
- Indoor and covered outdoor use
- Enhanced corrosion resistance

#### HD Galv Service Class 3

- Hot dipped galvanised to min 50 microns
- Outdoor use
- Superior corrosion resistance

FOR SIZES SEE

Pg. 12



Compatible with ALL major

# 34°

## CLIPPED HEAD NAIL GUN BRANDS





## EXOCET COLLATED STRIP NAILS

Ideal for flooring, wood framing and roofing and for use with most gas powered first fix nail guns (34°) such as the Paslode IM350 and IM350+ gas nailer.



### CORE USE

- Softwood
- Hardwood



**HEAD**  
CLIPPED FOR EASY  
LOADING

**POINT**  
DIAMOND TYPE FOR INSTANT  
TIMBER PENETRATION

### DURABILITY

- Bright (Service Class 1)
- Exogalv Plus (Service Class 2)
- HD Galvanised (Service Class 3)
- According to EN 14592: 2008 + A1: 2012

### MATERIAL

- Round cross-sectional nails for structural timber applications. Non-alloy steel rods according to EN 10016-2



Code	Finish	Length (mm)	Gauge (mm)	Nail Type	Box Qty
NITFRBN51280	BRIGHT (Service Class 1)	51	2.80	Full Ring	3300 + 3 GAS
NITFRBN63280		63	2.80	Full Ring	3300 + 3 GAS
NITFRBN75310		75	3.10	Full Ring	2200 + 2 GAS
NITPSBN90310		90	3.10	Straight	2200 + 2 GAS
NITFRZN51280	EXOGALV PLUS (Service Class 2)	51	2.80	Full Ring	3300 + 3 GAS
NITFRZN63280		63	2.80	Full Ring	3300 + 3 GAS
NITFRZN63310		63	3.10	Full Ring	2200 + 2 GAS
NITFRZN75310		75	3.10	Full Ring	2200 + 2 GAS
NITFRZN90310		90	3.10	Full Ring	2200 + 2 GAS
NITZFRZN51280		51	2.80	Full Ring	1100 + 1 GAS
NITZFRZN63280		63	2.80	Full Ring	1100 + 1 GAS
NITZFRZN75310		75	3.10	Full Ring	1100 + 1 GAS
NITZFRZN90310		90	3.10	Full Ring	1100 + 1 GAS
NITPSZN90310		90	3.10	Straight	2200 + 2 GAS
NITZPSZN90310	90	3.10	Straight	1100 + 1 GAS	
NITFRGN63280	HD GALV (Service Class 3)	63	2.80	Full Ring	3300 + 3 GAS
NITFRGN63310		63	3.10	Full Ring	2200 + 2 GAS
NITFRGN75310		75	3.10	Full Ring	2200 + 2 GAS
NITFRGN90310		90	3.10	Full Ring	2200 + 2 GAS
NITPSGN90310		90	3.10	Straight	2200 + 2 GAS
NIGAS	Exocet Gas Fuel Cell 40g to fit 1st Fix Gun				12

## EXOCET ANGLED BRADS

Second fix finishing nails - ideal for finish and trim work and for use with brad nailers (20°) such as the Paslode IM65A.

### CORE USE

- Softwood
- Hardwood



**HEAD**  
BRAD FOR A CONCEALED FINISH

### DURABILITY

- Galvanised



Code	Finish	Length (mm)	Gauge (mm)	Gun Type	Box Qty
NIBAG16032	GALVANISED	32	1.6	IM65A/IM250A	2000 + 2 GAS
NIBAG16038		38	1.6	IM65A/IM250A	2000 + 2 GAS
NIBAG16045		45	1.6	IM65A/IM250A	2000 + 2 GAS
NIBAG16050		50	1.6	IM65A/IM250A	2000 + 2 GAS
NIBAG16063		63	1.6	IM65A/IM250A	2000 + 2 GAS
NIGASB	Exocet Gas Fuel Cell to fit 2nd Fix Gun				12

## EXOCET STRAIGHT BRADS

Second fix finishing nails - ideal for finish and trim work and for use with brad nailers such as the Paslode IM65.

### CORE USE

- Softwood
- Hardwood



**HEAD**  
BRAD FOR A CONCEALED FINISH

### DURABILITY

- Galvanised



Code	Finish	Length (mm)	Gauge (mm)	Gun Type	Box Qty	
NIBSG16016	GALVANISED	16	1.6	IM65/IM250	2000 + 2 GAS	
NIBSG16019		19	1.6	IM65/IM250	2000 + 2 GAS	
NIBSG16025		25	1.6	IM65/IM250	2000 + 2 GAS	
NIBSG16032		32	1.6	IM65/IM250	2000 + 2 GAS	
NIBSG16038		38	1.6	IM65/IM250	2000 + 2 GAS	
NIBSG16045		45	1.6	IM65/IM250	2000 + 2 GAS	
NIBSG16050		50	1.6	IM65/IM250	2000 + 2 GAS	
NIBSG16064		64	1.6	IM65/IM250	2000 + 2 GAS	
NIGASB		Exocet Gas Fuel Cell to fit 2nd Fix Gun				12

## CORROSION RESISTANCE SCALE

### Bright Service Class 1

- Economical
- Indoor use
- Limited corrosion resistance

### Exogalv Service Class 1

- Electro-galvanised
- Indoor use
- Improved corrosion resistance

### Exogalv Plus Service Class 2

- Electro-galvanised to min. 12 microns
- Indoor & covered outdoor use
- Enhanced corrosion resistance

### HD Galv Service Class 3

- Hot dipped galvanised to min. 50 microns
- Outdoor use
- Superior corrosion resistance

### Stainless Steel Service Class 3

- A2 grade stainless steel
- Outdoor use
- Ultimate corrosion resistance



## IM360Ci PASLODE COLLATED STRIP NAILS

Round cross-sectional nails for structural timber applications. For use with 34° tools like IM360Ci or 360Xi gas nailers.



### CORE USE

- Softwood
- Hardwood



**HEAD**  
ROUND DRIVE FOR STRONGER HOLDING POWER

**POINT**  
DIAMOND TYPE FOR INSTANT TIMBER PENETRATION

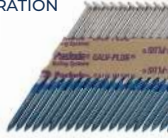

### DURABILITY

- Galv-PLUS (Service Class 2)
- According to EN 14592: 2008 + A1: 2012

### MATERIAL

- AISI 1008: low-carbon steel

Code	Finish	Length (mm)	Gauge (mm)	Nail Type	Box Qty
NG141070	GALV-PLUS (Service Class 2)	90	3.10	Straight	2200 + 2 GAS
NG141077		90	3.10	Straight	1100 + 1 GAS
NG141071		63	2.80	Full Ring	2200 + 2 GAS
NG141072		75	3.10	Full Ring	2200 + 2 GAS
NG141073		63	3.10	Full Ring	2200 + 2 GAS
NG141074		90	3.10	Full Ring	2200 + 2 GAS
NG141075		51	2.80	Full Ring	2200 + 2 GAS
NG141079		63	2.80	Full Ring	2200 + 2 GAS
NG141080		51	2.80	Full Ring	1100 + 1 GAS

## PASLODE ANGLED BRADS

The strong, stiff nail ensures consistent drivability. For use with brad nailers (20°) like the Paslode IM65A.

### CORE USE

- Softwood
- Hardwood



**HEAD**  
BRAD FOR A CONCEALED FINISH

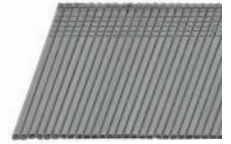

### DURABILITY

- Electro GALV (Service Class 1)
- According to EN 14592: 2008 + A1: 2012

Code	Finish	Length (mm)	Gauge (mm)	Gun Type	Box Qty
NG300270	E-GALV (Service Class 1)	32	1.6	IM65A/IM250A	2000 + 2 GAS
NG300271		38	1.6	IM65A/IM250A	2000 + 2 GAS
NG300272		45	1.6	IM65A/IM250A	2000 + 2 GAS
NG300273		51	1.6	IM65A/IM250A	2000 + 2 GAS
NG300274		63	1.6	IM65A/IM250A	2000 + 2 GAS
NIGASB	Exocet Gas Fuel Cell to fit 2nd Fix Gun				12

## PASLODE STRAIGHT BRADS

Creates a small hole to provide an excellent finish. For use with brad nailers like the Paslode IM65.

### CORE USE

- Softwood
- Hardwood



**HEAD**  
BRAD FOR A CONCEALED FINISH

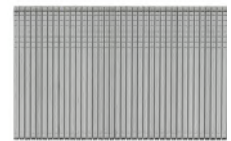

### DURABILITY

- Electro GALV (Service Class 1)
- According to EN 14592: 2008 + A1: 2012

Code	Finish	Length (mm)	Gauge (mm)	Gun Type	Box Qty
NG921585	E-GALV (Service Class 1)	16	1.6	IM65/IM250	2000 + 2 GAS
NG921586		19	1.6	IM65/IM250	2000 + 2 GAS
NG921587		25	1.6	IM65/IM250	2000 + 2 GAS
NG921588		32	1.6	IM65/IM250	2000 + 2 GAS
NG921589		38	1.6	IM65/IM250	2000 + 2 GAS
NG921590		45	1.6	IM65/IM250	2000 + 2 GAS
NG921591		50	1.6	IM65/IM250	2000 + 2 GAS
NG921592		63	1.6	IM65/IM250	2000 + 2 GAS
NIGASB		Exocet Gas Fuel Cell to fit 2nd Fix Gun			

## IM350 PASLODE COLLATED STRIP NAILS

Round cross-sectional nails for structural timber applications. For use with 34° tools like the IM350 and IM350+ gas nailer.



### CORE USE

- Softwood
- Hardwood



**HEAD**  
CLIPPED FOR EASY LOADING

**POINT**  
DIAMOND TYPE FOR INSTANT TIMBER PENETRATION



### DURABILITY

- Bright (Service Class 1)
- Galv-PLUS (Service Class 2)
- HD Galvanised (Service Class 3)
- According to EN14592: 2008 + A1: 2012

### MATERIAL

- AISI 1008: low-carbon steel

Code	Finish	Length (mm)	Gauge (mm)	Nail Type	Box Qty
NG141233	BRIGHT (Service Class 1)	90	3.1	Straight	2200 + 2GAS
NG141204	GALV-PLUS (Service Class 2)	51	2.8	Full Ring	3300 + 3GAS
NG141210		63	2.8	Full Ring	3300 + 3GAS
NG141221		63	3.1	Full Ring	2200 + 2GAS
NG141227		75	3.1	Full Ring	2200 + 2GAS
NG141256		51	2.8	Full Ring	1100 + 1GAS
NG141259		63	2.8	Full Ring	1100 + 1GAS
NG141234		90	3.1	Straight	2200 + 2GAS
NG141236	HD GALV (Service Class 3)	90	3.1	Part Ring	2200 + 2GAS
NG141265		75	3.1	Full Ring	1100 + 1GAS
NG141267		90	3.1	Straight	1100 + 1GAS
NIGAS	Exocet Gas Fuel Cell 40g to fit 1st Fix Gun				12

## PASLODE COLLATED TWIST NAILS

Ideal for installing hangers brackets and straps. For use with PPNXi/PPN35Ci specialist nail guns.



### CORE USE

- Softwood
- Hardwood



**HEAD**  
FULL FOR BEST QUALITY FINISH

**SHANK**  
TWISTED - REQUIRES LESS DRIVING FORCE THAN RING SHANK NAILS

### DURABILITY

- Galv-PLUS (Service Class 2)
- According to EN 14592: 2008 + A1: 2012

### MATERIAL

- AISI 1045: medium-carbon steel



Code	Finish	Length (mm)	Gauge (mm)	Nail Type	Box Qty
NG141185	GALV-PLUS (Service Class 2)	35	3.40	Twisted	1100 + 1 GAS

## COLLATED STRIP NAIL HEADS



Round Drive Head



**PASLODE**  
IM360Ci  
360Xi  
nailers



D-Head (clipped)



**PASLODE**  
IM350  
IM350+  
nailers



## ROUND WIRE NAILS

Versatile, strong, general purpose nail. Mostly used to secure floor and roof joists, partitions and heavy duty fencing. Ideal for woodworking and joinery applications where strength is key.



### CORE USE

- Softwood
- Hardwood



**HEAD**  
LARGE FOR INCREASED HOLDING POWER



### DURABILITY

- Bright (Service Class 1)
- Galvanised (Service Class 3)

### MATERIAL

- Non-alloy steel rods in accordance with EN10016-2
- Manufactured to BS1202

Code	Finish	Length (mm)	Gauge (mm)	Avg. Nail Count/Kg	Box Weight (kg)
NRSB0025180	BRIGHT (Service Class 1)	25	1.80	1720	25
NRSB0030236		30	2.36	840	25
NRSB0040236		40	2.36	750	25
NRSB0040265		40	2.65	575	25
NRSB0050265		50	2.65	440	25
NRSB0050335		50	3.35	290	25
NRSB0065265		65	2.65	350	25
NRSB0065335		65	3.35	230	25
NRSB0075335		75	3.35	195	25
NRSB0075375		75	3.75	154	25
NRSB0100400		100	4.00	88	25
NRSB0100450		100	4.50	77	25
NRSB0125560		125	5.60	42	25
NRSB0150600		150	6.00	29	25
NRSG0025180		GALVANISED (Service Class 3)	25	1.80	1720
NRSG0030236	30		2.36	840	25
NRSG0040236	40		2.36	750	25
NRSG0040265	40		2.65	575	25
NRSG0050236	50		2.36	550	25
NRSG0050265	50		2.65	440	25
NRSG0065265	65		2.65	350	25
NRSG0065300	65		3.00	275	25
NRSG0065335	65		3.35	230	25
NRSG0075335	75		3.35	195	25
NRSG0075375	75		3.75	154	25
NRSG0090400	90		4.00	106	25
NRSG0100400	100		4.00	88	25
NRSG0100450	100		4.50	77	25
NRSG0125500	125		5.00	53	25
NRSG0125560	125	5.60	42	25	
NRSG0150600	150	6.00	29	25	
NRSG0200800	200	8.00	13	25	

## OVAL BRAD NAILS

Traditional carpentry nail which is used for door jambs, floors and skirting boards.

### CORE USE

- Softwood
- Hardwood



**HEAD**  
CAN BE PUNCHED BELOW THE SURFACE FOR A SMOOTH FINISH

### DURABILITY

- Bright (Service Class 1)
- Galvanised (Service Class 3)

### MATERIAL

- Manufactured to BS1202

**SHANK**  
OVAL SHAPE AVOIDS SPLITTING THE WOOD



Code	Finish	Size (mm)	Avg. Nail Count/Kg	Box Weight (kg)
NOBB0025	BRIGHT (Service Class 1)	25	2530	25
NOBB0030		30	1480	25
NOBB0040		40	940	25
NOBB0050		50	470	25
NOBB0065		65	230	25
NOBB0075		75	125	25
NOBB0100		100	64	25
NOBB0125		125	50	25
NOBB0150		150	40	25
NOBG0040		GALVANISED (Service Class 3)	40	940
NOBG0050	50		470	25
NOBG0065	65		230	25

## LOST HEAD NAILS

Mostly used for all wall, ceiling, flooring and built-in furnishing jobs, for carpentry work where appearance matters.

### CORE USE

- Softwood
- Hardwood



**HEAD**  
SMALL TO REDUCE TIMBER DEFORMATION WHEN PUNCHED BELOW THE SURFACE

### DURABILITY

- Bright (Service Class 1)
- Sherardised (Service Class 2)

### MATERIAL

- Manufactured to BS1202



Code	Finish	Length (mm)	Gauge (mm)	Avg. Nail Count/Kg	Box Weight (kg)
NLSB0040236	BRIGHT (Service Class 1)	40	2.36	760	25
NLSB0050265		50	2.65	420	25
NLSB0050300		50	3.00	360	25
NLSB0065335		65	3.35	240	25
NLSB0075375		75	3.75	160	25
NLSS0040236	SHERARDISED (Service Class 2)	40	2.36	760	25
NLSS0050300		50	3.00	360	25
NLSS0065335		65	3.35	240	25
NLSS0075375	75	3.75	160	25	

## WE RECOMMEND...

Our 25kg boxed **Ferrous Nails** are made from mild steel and are either Bright, Sherardised, Galvanised or Zinc & Yellow Passivated.

Our recommendation is to use our **Galvanised Nails** for uncovered outdoor use.

## ANNULAR RING NAILS

Often used in the making of pallets or fastening flooring sheets where superior holding power is needed.



### CORE USE

- Softwood
- Hardwood
- MDF
- Plywood



SHANK  
THREADED FOR EXTRA  
WITHDRAWAL RESISTANCE

### DURABILITY

- Bright (Service Class 1)
- Sherardised (Service Class 2)
- Galvanised (Service Class 3)
- Zinc & Yellow Passivated (not UKCA marked)

### MATERIAL

- Non-alloy steel rods in accordance with EN10016-2
- Manufactured to BS1202



Code	Finish	Length (mm)	Gauge (mm)	Avg. Nail Count/Kg	Box Weight (kg)	
NASB0020200	BRIGHT (Service Class 1)	20	2.00	1990	25	
NASB0025200		25	2.00	1430	25	
NASB0030236		30	2.36	840	25	
NASB0040265		40	2.65	575	25	
NASB0050265		50	2.65	440	25	
NASB0050335		50	3.35	290	25	
NASB0065335		65	3.35	230	25	
NASB0075375		75	3.75	154	25	
NASB0100500		100	5.00	66	25	
NASB0125500		125	5.00	53	25	
NASS0040265		SHERARDISED (Service Class 2)	40	2.65	575	25
NASS0050265			50	2.65	440	25
NASS0050335	50		3.35	290	25	
NASS0065335	65		3.35	230	25	
NASS0075375	75		3.75	154	25	
NASS0100500	100		5.00	66	25	
NASG0065335	GALVANISED (Service Class 3)	65	3.35	230	25	
NAPZ0030250	ZINC & YELLOW PASSIVATED	30	2.65	660	25	
NAPZ0040265		40	2.65	575	25	
NAPZ0050265		50	2.65	440	25	

## PANEL PINS

Lighter duty pin - ideal for lightweight and decorative jobs, e.g. fixing plywood parts to solid timber, putting skirting together or fixing the backs of cupboards. Sherardised panel pins can be used on external glazing beads.

### CORE USE

- Softwood
- Hardwood
- Plywood



HEAD  
SMALL FOR A FLUSH FINISH

### DURABILITY

- Bright (Service Class 1)
- Sherardised (Service Class 2)

### MATERIAL

- Manufactured to BS1202



Code	Finish	Length (mm)	Gauge (mm)	Avg. Nail Count/Kg	Box Weight (kg)
NPSB0015125	BRIGHT (Service Class 1)	15	1.00	6400	25
NPSB0020160		20	1.60	3140	25
NPSB0025160		25	1.60	2340	25
NPSB0030160		30	1.60	1900	25
NPSB0040160		40	1.60	1590	25
NPSB0050200		50	2.00	750	25
NPSS0020160	SHERARDISED (Service Class 2)	20	1.60	3140	25
NPSS0025160		25	1.60	2340	25
NPSS0030160		30	1.60	1900	25
NPSS0040160		40	1.60	1590	25
NPSS0050200		50	2.00	750	25

## VENEER PINS

Ideal for most lightweight and decorative tasks indoors or for fixing decorative timber mouldings. Specifically designed to penetrate hard surfaced veneers.

### CORE USE

- Softwood
- Hardwood



HEAD  
SMALL TO REDUCE  
SPLITTING OR  
CRACKING OF THE  
VENEER

### DURABILITY

- Bright (Service Class 1)

### MATERIAL

- Manufactured to BS1202



Code	Finish	Length (mm)	Gauge (mm)	Avg. Nail Count/Kg	Box Weight (kg)
NLSB0020100	BRIGHT (Service Class 1)	20	1.00	6000	25
NLSB0025100		25	1.00	5800	25

## ANNULAR RING NAIL SPECIFICATION

Mild steel wire nails with a ring shank, a flat head and a round point.

Head diameter (D) = 2.4 x d.

### OTHER AVAILABLE FINISHES:

- A2 STAINLESS STEEL
- ALUMINIUM
- COPPER
- SILICON BRONZE

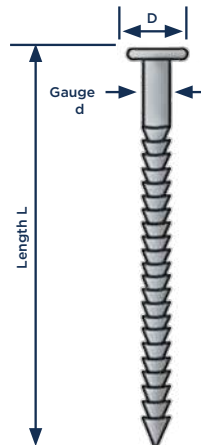

All our **boxed ferrous nails** are provided in 25kg boxes, apart from Insulation and Springhead nails which are boxed in 10kg.



## CUT CLASP NAILS

A traditional cut nail that provides a very strong grip and authentic look. Used for rough fixing of timber to brick or blockwork, particularly skirting boards or wooden door frames.

### CORE USE

- Softwood
- Hardwood



**POINT**  
FLATTENED TO AVOID  
SPLITTING WOOD



### DURABILITY

- Bright (Service Class 1)

### MATERIAL

- Manufactured to BS1202

Code	Finish	Size (mm)	Avg. Nail Count/Kg	Box Weight (kg)
NFCB0040	BRIGHT (Service Class 1)	40	616	25
NFCB0050		50	286	25
NFCB0065		65	171	25
NFCB0075		75	103	25
NFCB0100		100	48	25

## CUT FLOOR BRADS

A traditional cut nail which provides a strong grip and authentic look. Used to fasten floorboards to joists and ideal for tongued and grooved floors.

### CORE USE

- Softwood
- Hardwood



**HEAD**  
CAN EASILY BE PUNCHED BELOW  
THE SURFACE OF THE WOOD

**POINT**  
FLATTENED TO AVOID  
SPLITTING WOOD



### DURABILITY

- Bright (Service Class 1)

### MATERIAL

- Manufactured to BS1202

Code	Finish	Size (mm)	Avg. Nail Count/Kg	Box Weight (kg)
NFFB0050	BRIGHT (Service Class 1)	50	264	25
NFFB0065		65	154	25

## WE RECOMMEND...

Our **Cut Clasp Nails** and **Cut Floor Brads** are made from black rolled steel and have a flat rectangular point.

Our recommendation is to orient the wide section of the nail with the grain. When using larger nails, pre-drill slightly undersized holes in the timber beforehand to ease insertion.



## BS1202 GALVANISED NAILS

- Made from mild steel for **strength** and **malleability**
- Hot dipped galvanised to comply with **BS EN ISO 1461**
- They have a **minimum coat weight of 300 g/m<sup>2</sup>**
- For areas with high humidity **use stainless steel, copper or aluminium nails instead**



## SQUARE TWIST NAILS

For use with joist hangers and restraint straps. Can also be used for external cladding or felt.

UK  
CA

### CORE USE

- Softwood
- Hardwood



**HEAD**  
MEDIUM SIZED FOR  
INCREASED HOLDING POWER

**SHANK**  
TWISTED TO GIVE SUPERIOR  
PULL-OUT RESISTANCE

### DURABILITY

- Sherardised (Service Class 2)
- Galvanised (Service Class 3)

### MATERIAL

- Non-alloy steel rods in accordance with EN10016-2
- Manufactured to BS1202



Code	Finish	Length (mm)	Gauge (mm)	Avg. Nail Count/Kg	Box Weight (kg)
NSSS0030375	SHERARDISED (Service Class 2)	30	3.75	350	25
NSSS0040375		40	3.75	300	25
NSSG0030375	GALVANISED (Service Class 3)	30	3.75	350	25
NSSG0040375		40	3.75	300	25

## DRIVE SCREWS

Easily driven nail best suited for wood joints with substantial lateral or racking loads. Recommended for fastening hard woods and end-grain wood. Used in conjunction with plastic roofing washers to secure corrugated sheeting.

### CORE USE

- Softwood
- Hardwood



**SHANK**  
TWISTED THREAD  
FOR EASY DRIVING

### DURABILITY

- Galvanised (Service Class 3)

### MATERIAL

- Manufactured to BS1202



Code	Finish	Size (mm)	Avg. Nail Count/Kg	Box Weight (kg)
NDDG0075	GALVANISED (Service Class 3)	75	59	25
NDDG0100		100	35	25
NDDG0115		115	31	25
NDDG0125		125	29	25
NDDG0150		150	26	25



## CLOUT NAILS

A popular general purpose nail also suitable for soft materials. Applications include securing roof felt, wire fencing and roofing slates.



### CORE USE

- Softwood
- Felt



**HEAD**  
LARGE SIZED TO STOP ANY PULL THROUGH ON THE MATERIAL BEING FIXED

### DURABILITY

- Galvanised (Service Class 3)

### MATERIAL

- Non-alloy steel rods in accordance with EN10016-2
- Manufactured to BS1202



Code	Finish	Length (mm)	Gauge (mm)	Avg. Nail Count/	Box Weight (kg)
NCSG0020265	GALVANISED (Service Class 3)	20	2.65	1035	25
NCSG0025265		25	2.65	815	25
NCSG0030265		30	2.65	660	25
NCSG0030300		30	3.00	470	25
NCSG0040265		40	2.65	570	25
NCSG0040335		40	3.35	350	25
NCSG0050265		50	2.65	430	25
NCSG0050335		50	3.35	290	25
NCSG0065265		65	2.65	330	25
NCSG0065375		65	3.75	180	25
NCSG0075375		75	3.75	150	25
NCSG0100450		100	4.50	75	25

## JAGGED SHANK NAILS

Also known as plasterboard nails. Use 30mm (1¼") long for 9.5mm thick plasterboard or 40mm (1½") long for 12.5mm thick plasterboard.



### CORE USE

- Softwood
- Plasterboard



**HEAD**  
COUNTERSUNK FOR A FLUSH FINISH

**SHANK**  
JAGGED FOR SUPERIOR HOLDING POWER

### DURABILITY

- Galvanised (Service Class 3)

### MATERIAL

- Non-alloy steel rods in accordance with EN10016-2
- Manufactured to BS1202



Code	Finish	Length (mm)	Gauge (mm)	Avg. Nail Count/Kg	Box Weight (kg)
NJSG0030265	GALVANISED (Service Class 3)	30	2.65	700	25
NJSG0040265		40	2.65	570	25

## INSULATION NAILS

Also known as slab nails. Most commonly used to fix insulation panels.

### CORE USE

- Softwood
- Insulation

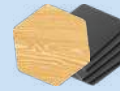

**HEAD**  
LARGE WASHER HEAD FOR STRONG HOLDING POWER

**SHANK**  
THIN WITH A SHARP POINT FOR EASY PENETRATION

### DURABILITY

- Galvanised (Service Class 3)

### MATERIAL

- Manufactured to BS1202



Code	Finish	Length (mm)	Gauge (mm)	Avg. Nail Count/Kg	Box Weight (kg)
NSLG0100335	GALVANISED (Service Class 3)	100	3.35	82	10
NSLG0125335		125	3.35	73	10
NSLG0150375		150	3.75	61	10
NSLG0180450		180	4.50	40	10
NSLG0200450		200	4.50	34	10

## ELH CLOUT NAILS

An extra large headed (ELH) clout nail with a plain, round shank. Ideal for fastening plastic sheeting and non-ridged roofing felt. They can also be used for attaching sheet metal to wood.



### CORE USE

- Softwood
- Plastic
- Sheet metal

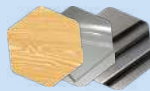

**HEAD**  
EXTRA LARGE IDEAL FOR FASTENING PLASTIC SHEETING

### DURABILITY

- Galvanised (Service Class 3)

### MATERIAL

- Non-alloy steel rods in accordance with EN10016-2
- Manufactured to BS1202



Code	Finish	Length (mm)	Gauge (mm)	Avg. Nail Count/Kg	Box Weight (kg)
NESG0013300	GALVANISED (Service Class 3)	13	3.00	690	25
NESG0015300		15	3.00	650	25
NESG0020300		20	3.00	580	25
NESG0025300		25	3.00	485	25
NESG0030300		30	3.00	540	25
NESG0040300		40	3.00	350	25
NESG0050300		50	3.00	330	25

## SPRINGHEAD NAILS

Used for securing galvanised steel sheeting. Ideal for fixing corrugated roofing.

### CORE USE

- Softwood
- Sheet metal



**HEAD**  
CONVEX TO COVER THE HOLE MADE IN THE SHEET

**SHANK**  
TWISTED FOR RESISTANCE TO PULLOUT

### DURABILITY

- Galvanised (Service Class 3)

### MATERIAL

- Manufactured to BS1202



Code	Finish	Length (mm)	Gauge (mm)	Avg. Nail Count/Kg	Box Weight (kg)
NSPG0065335	GALVANISED (Service Class 3)	65	3.35	140	10
NSPG0075335		75	3.35	129	10



## CUT POINT STAPLES

Used in fencing for fixing netting and fencing wire to wooden posts. The barbed variant is more resistant to traction as the wood dries and cracks.

### CORE USE

- Softwood
- Hardwood



STANDARD



### DURABILITY

- Galvanised (Service Class 3)

BARBED



### MATERIAL

- Galvanised steel

\* LENGTH IS FROM BOTTOM TO TOP OF U

Code	Finish	Length* (mm)	Type	Gauge (mm)	Avg. Staple Count/Kg	Pack Weight (kg)
NWSG015	GALVANISED (Service Class 3)	15	Standard	1.60	2190	25
NWSG020		20	Standard	2.00	1079	25
NWSG025		25	Standard	2.65	486	25
NWSG030		30	Standard	3.55	260	25
NWSG040		40	Standard	4.00	135	25
NWSG050		50	Standard	5.00	87	25
NWSGPPB0040400		40	Barbed	4.00	135	20
NWSGPPB1040400		40	Barbed	4.00	135	10

## PRESSER POINT STAPLES

Presser point can be 'pressed' into the wooden post and will not need to be held in place when being hammered in. Provided in tubs with a carry handle.

### CORE USE

- Softwood
- Hardwood



### DURABILITY

- Galvanised (Service Class 3)

### MATERIAL

- Galvanised steel



\* LENGTH IS FROM BOTTOM TO TOP OF U

Code	Finish	Length* (mm)	Gauge (mm)	Avg. Staple Count/Kg	Tub Weight (kg)
NWSGPP0030355	GALVANISED (Service Class 3)	30	3.55	360	20
NWSGPP0040400		40	4.00	135	20
NWSGPP1030355		30	3.55	360	10
NWSGPP1040400		40	4.00	135	10
NWSGPP2030355		30	3.55	360	5
NWSGPP2040400		40	4.00	135	5

## MASONRY NAILS

Hardened steel nails capable of being driven into masonry, concrete or brickwork. Ideal for fixing wall batten, picture or dado rails. The washed masonry nail is designed for PVC or steel channelling - when installed gives an enlarged head and secure finish (washer 12mm).

### CORE USE

- Masonry
- Brickwork
- Concrete

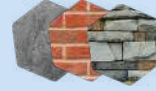

COUNTERSUNK



### DURABILITY

- Bright Zinc Plated

FLAT



### MATERIAL

- Hardened steel

WASHERED



PROVIDED IN SMALL RETAIL BOXES

Code	Finish	Length (mm)	Gauge (mm)	Head Type	Box Qty
NFPZ25020	BZP	20	2.50	Csk	100
NFPZ25025		25	2.50		100
NFPZ2503		30	2.50		100
NFPZ2504		40	2.50		100
NFPZ25045		45	2.50		100
NFPZ2505		50	2.50		100
NFPZ2506		60	2.50		100
NFPZ305		50	3.00		100
NFPZ306		60	3.00		100
NFPZ307		70	3.00		100
NFPZ308		80	3.00	100	
NFPZ3504		40	3.50	Flat	100
NFPZ3505		50	3.50		100
NFPZ3506		60	3.50		100
NFPZ3507		70	3.50		100
NFPZ35075		75	3.50		100
NFPZ3508		80	3.50		100
NFPZ3509		90	3.50		100
NFPZ351		100	3.50		100
NFPZW37022		22	3.70		Washer
NFPZW37027	27	3.70	100		
NFPZW37032	32	3.70	100		
NFPZW37037	37	3.70	100		
NFPZW37042	42	3.70	100		
NFPZW37047	47	3.70	100		
NFPZW37052	54	3.70	100		
NFPZW37062	62	3.70	100		
NFPZW37072	72	3.70	50		
NFPZW37082	82	3.70	50		
NFPZW37097	97	3.70	50		

## WE RECOMMEND...

Hammering masonry nails into concrete involves heavy stresses. Our recommendation is to use a **Framing Hammer** to make the job easier.



## A2 STAINLESS STEEL NAILS & PINS

Standard grade of ISO 3506 stainless steel (also known as A2, Type 304 or 18/8) for ultimate corrosion resistance

### ROUND WIRE NAILS

Versatile, strong, general purpose nail that offers excellent corrosion resistance, cleanability and the ability to handle extremely low (cryogenic) and high temperatures.

#### CORE USE

- Softwood
- Hardwood



**HEAD**  
CHECKERED SURFACE TO PREVENT SLIPPAGE WHEN STRUCK

#### DURABILITY

- Stainless Steel (Service Class 3)
- Ideal for uncovered outdoor use

#### MATERIAL

- Grade 304
- A2 Austenitic Stainless Steel
- Manufactured to BS1202



A2

Code	Length (mm)	Gauge (mm)	Avg. Nail Count/Kg	Pack Weight (kg)
NRST4040265	40	2.65	510	1
NRST4050265	50	2.65	410	1
NRST4050335	50	3.35	275	1
NRST4065335	65	3.35	210	1
NRST4075375	75	3.75	150	1
NRST4100450	100	4.50	75	1

- **High hardness** level
- Consistent dimensional stability
- Does not discolour the wood
- **Service Class 3** according to EN 1995-1-1
- Manufactured to **BS1202**
- Checkered head surface on Round Wire and Annular Ring Nails to prevent slippage when struck



### LOST HEAD NAILS

Small headed nail ideal for external carpentry work where appearance matters. Offers excellent corrosion resistance and ideal in areas with a moderate salt atmosphere.

#### CORE USE

- Softwood
- Hardwood



**HEAD**  
SMALL TO REDUCE TIMBER DEFORMATION WHEN PUNCHED BELOW THE SURFACE

#### DURABILITY

- Stainless Steel (Service Class 3)
- Ideal for uncovered outdoor use

#### MATERIAL

- Grade 304
- A2 Austenitic Stainless Steel
- Manufactured to BS1202



A2

Code	Length (mm)	Gauge (mm)	Avg. Nail Count/Kg	Pack Weight (kg)
NLST4040265	40	2.65	510	1
NLST4050265	50	2.65	410	1
NLST4065335	65	3.35	235	1

### ANNULAR RING CLOUT NAILS

Annular ring provides additional holding power where increased grip is required. Ideal for roofing and cladding applications in areas with a moderate salt atmosphere.

#### CORE USE

- Softwood
- Hardwood



**HEAD**  
CHECKERED SURFACE TO PREVENT SLIPPAGE WHEN STRUCK

#### DURABILITY

- Stainless Steel (Service Class 3)
- Ideal for uncovered outdoor use

#### MATERIAL

- Grade 304
- A2 Austenitic Stainless Steel
- Manufactured to BS1202

**SHANK**  
THREADED FOR EXTRA WITHDRAWAL RESISTANCE



A2

Code	Length (mm)	Gauge (mm)	Avg. Nail Count/Kg	Pack Weight (kg)
NAST4025335	25	3.35	505	1
NAST4030265	30	2.65	600	1
NAST4031180	31	1.80	1500	1
NAST4035265	35	2.65	540	1
NAST4038265	38	2.65	510	1
NAST4038335	38	3.35	350	1
NAST4045265	45	2.65	470	1
NAST4045335	45	3.35	290	1
NAST4050265	50	2.65	410	1
NAST4050335	50	3.35	275	1
NAST4065265	65	2.65	345	1
NAST4065335	65	3.35	210	1
NAST4075375	75	3.75	150	1
NAST4100375	100	3.75	113	1

### PANEL PINS

A pin for lightweight and decorative jobs where the head needs to be concealed (cabinet work, joinery, fixing mouldings). Offers excellent corrosion resistance, cleanability and the ability to handle extremely low (cryogenic) and high temperatures.

#### CORE USE

- Softwood
- Hardwood



**HEAD**  
SMALL FOR A FLUSH FINISH

#### DURABILITY

- Stainless Steel (Service Class 3)
- Ideal for uncovered outdoor use

#### MATERIAL

- Grade 304
- A2 Austenitic Stainless Steel
- Manufactured to BS1202



A2

Code	Length (mm)	Gauge (mm)	Avg. Nail Count/Kg	Pack Weight (kg)
NPST4020160	20	1.60	2700	1
NPST4025160	25	1.60	2200	1
NPST4030160	30	1.60	1880	1
NPST4040160	40	1.60	1420	1
NPST4050200	50	2.00	745	1



## ALUMINIUM CLOUT NAILS

Popular large headed roofing nail used for metal roofs, asphalt shingles or composite roofs.

### CORE USE

- Softwood
- Shingles
- Metal



**HEAD**  
LARGE FOR INCREASED HOLDING POWER

### DURABILITY

- Ideal for uncovered outdoor use

### MATERIAL

- Manufactured using aluminium alloy which gives the nails corrosion resistance of nearly 500 times that of bright nails
- Manufactured to BS1202



Code	Length (mm)	Gauge (mm)	Avg. Nail Count/Kg	Pack Weight (kg)
NCAB430265	30	2.65	1800	1
NCAB430300	30	3.00	1490	1
NCAB430335	30	3.35	1230	1
NCAB438265	38	2.65	1300	1
NCAB438300	38	3.00	1200	1
NCAB438335	38	3.35	950	1
NCAB440265	40	2.65	1300	1
NCAB440335	40	3.35	950	1
NCAB445335	45	3.35	870	1
NCAB450265	50	2.65	1170	1
NCAB450300	50	3.00	940	1
NCAB450335	50	3.35	775	1
NCAB455335	55	3.35	720	1
NCAB460335	60	3.35	650	1
NCAB465335	65	3.35	605	1
NCAB470335	70	3.35	560	1
NCAB475335	75	3.35	532	1
NCAB1030265	30	2.65	1800	10
NCAB1030335	30	3.35	1230	10
NCAB1038265	38	2.65	1300	10
NCAB1038335	38	3.35	950	10
NCAB1040265	40	2.65	1300	10
NCAB1040335	40	3.35	950	10
NCAB1045335	45	3.35	950	10
NCAB1050265	50	2.65	1170	10
NCAB1050300	50	3.00	940	10
NCAB1050335	50	3.35	775	10
NCAB1065335	65	3.35	605	10

## ALUMINIUM ANNULAR RING NAILS

Large head nail with annular ringed shank used for fixing roofing tiles and roofing slates where extra grip is needed. Not recommended for use in coastal areas.

### CORE USE

- Softwood
- Felt
- Metal

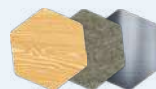

**HEAD**  
LARGE FOR INCREASED HOLDING POWER

**SHANK**  
THREADED FOR EXTRA WITHDRAWAL RESISTANCE

### DURABILITY

- Ideal for uncovered outdoor use

### MATERIAL

- Manufactured using aluminium alloy which gives the nails corrosion resistance of nearly 500 times that of bright nails
- Manufactured to BS1202



Code	Length (mm)	Gauge (mm)	Avg. Nail Count/Kg	Pack Weight (kg)
NAAA438335	38	3.35	960	1
NAAA445335	45	3.35	860	1
NAAA450335	50	3.35	770	1
NAAA455335	55	3.35	720	1
NAAA465375	65	3.75	600	1
NAAA470375	75	3.75	550	1

## ALUMINIUM TILE PEGS

Used by roofers for pre-drilled pegging tiles including slate or hand-made clay roof tiles. Also used with roofing felt and sheets. Not recommended for use in coastal areas.

### CORE USE

- Clay tiles
- Slate tiles
- Felt



**SHARP**

### DURABILITY

- Ideal for uncovered outdoor use

### MATERIAL

- Manufactured using aluminium alloy which gives corrosion resistance of nearly 500 times that of bright nails
- Manufactured to BS1202

**BLUNT**  
IDEAL FOR HANGING TILES WITHOUT TEARING FELT



Code	Point Type	Length (mm)	Gauge (mm)	Avg. Nail Count/Kg	Pack Weight (kg)
NTAB430450	Sharp	30	4.50	680	1
NTAB440450		40	4.50	520	1
NTAB1030450		30	4.50	680	10
NTAB1040450		40	4.50	520	10
NTAB1050450		50	4.50	400	10
NTABB1040700	Blunt	40	7.00	160	10
NTABB1050700		50	7.00	160	10



## ALUMINIUM NAILS

Their light weight minimises additional weight when used for roofing and makes them easier to install.

These nails are ideal in urban and industrial areas.

## COPPER & ALUMINIUM NAILS

Our Copper and Aluminium Clouts and Annular Ring Nails are manufactured according to **BS1202** and **EN 10230-1:1999**

### TOLERANCES

- L:** ± 0.5d
- d:** ± 0.22mm
- D:** ± 0.05D

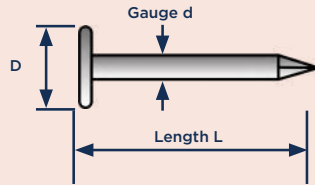

EN 10230-1:1999 TABLE 7

Nominal Diameter/ Gauge (mm)	Head Diameter (mm)	Tolerance on Head Diameter (mm)
2.20	7.3	0.36
2.35 / 2.40 / 2.50	7.9	0.40
2.60 / 2.70 / 2.80	8.9	0.45
2.90 / 3.00 / 3.20	9.9	0.50
3.35	11.0	0.53
3.50	11.2	0.56
3.75	11.8	0.59
4.50	13.1	0.66

## COPPER CLOUT NAILS

A rust free fixing ideal for fixing manmade and natural slates. Often used in maritime applications. Copper also has similar life expectancy to lead and holds without restricting thermal movement.

### CORE USE

- Clay tiles
- Slate tiles
- Lead



**HEAD**  
LARGE FOR INCREASED  
HOLDING POWER

### DURABILITY

- Ideal for uncovered outdoor use and coastal areas
- They last up to 10 times longer than galvanised

### MATERIAL

- Manufactured to BS1202



Code	Length (mm)	Gauge (mm)	Avg. Nail Count/Kg	Pack Weight (kg)
NCCB430265	30	2.65	534	1
NCCB430300	30	3.00	418	1
NCCB430335	30	3.35	349	1
NCCB432265	32	2.65	600	1
NCCB432300	32	3.00	440	1
NCCB435265	35	2.65	470	1
NCCB435300	35	3.00	370	1
NCCB435335	35	3.35	320	1
NCCB438265	38	2.65	420	1
NCCB438300	38	3.00	365	1
NCCB438335	38	3.35	274	1
NCCB445335	45	3.35	247	1
NCCB450265	50	2.65	350	1
NCCB450335	50	3.35	226	1
NCCB030265	30	2.65	534	25
NCCB030335	30	3.35	349	25
NCCB035335	35	3.35	320	25
NCCB038265	38	2.65	420	25
NCCB038335	38	3.35	274	25
NCCB045335	45	3.35	250	25
NCCB050335	50	3.35	226	25

## COPPER ANNULAR RING NAILS

Commonly used to secure lead flashings and other roofing applications. For use in areas of high humidity and pollution as they are more durable than galvanised nails when exposed to moisture, salt and other damaging particles in the air.

### CORE USE

- Clay tiles
- Slate tiles
- Lead



**SHANK**  
THREADED FOR EXTRA  
WITHDRAWAL RESISTANCE

### DURABILITY

- Ideal for uncovered outdoor use and coastal areas
- They last up to 10 times longer than galvanised

### MATERIAL

- Manufactured to BS1202



Code	Length (mm)	Gauge (mm)	Avg. Nail Count/Kg	Pack Weight (kg)
NACC425335	25	3.35	406	1

## SILICON BRONZE ANNULAR RING NAILS

Highly corrosion resistant copper alloy nail used in the fixing of cedar shingles as the acidic nature of the wood can cause staining with iron-based materials. Annular ring barbs create a locking effect and nail resists pull out stresses.

### CORE USE

- Softwood
- Hardwood
- Cedar Shingles



**SHANK**  
THREADED FOR EXTRA  
WITHDRAWAL RESISTANCE

### DURABILITY

- Highly corrosion resistant

### MATERIAL

- Manufactured using copper alloy
- Manufactured to BS1202



Code	Length (mm)	Gauge (mm)	Avg. Nail Count/Kg	Pack Weight (kg)
NABR3030180	31	1.80	1530	1
NABR4045335	45	3.35	268	1
NABR4050335	50	3.35	248	1

**Copper Nails** are extremely malleable and become coated with green patina when exposed to moisture which protects the copper even further.

Our recommendation is to use copper nails in areas of higher humidity and rainfall.

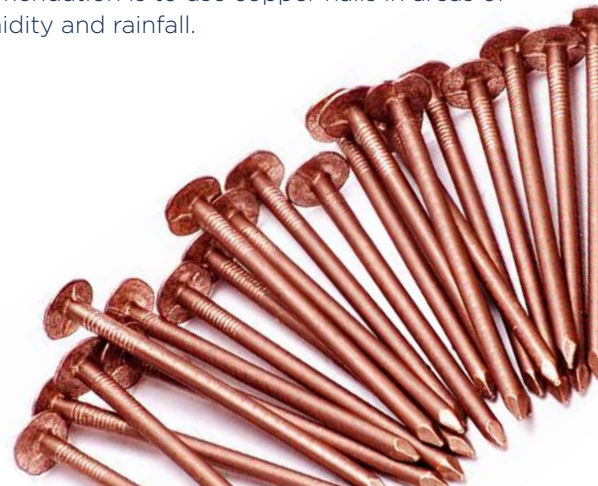

## FASCIA NAILS & PINS - BOXED

Self masking, hammer in fasteners.

### CORE USE

- Softwood
- Hardwood
- Used on exposed fixing areas, particularly UPVC



**HEAD**  
POLYTOP HEAD IS  
CORROSION RESISTANT  
& MAINTENANCE FREE

**SHANK**  
PROVIDES GOOD GRIP



**A4**

### DURABILITY

- Able to withstand harsh environments
- According to EN 1995-1-1

### MATERIAL

- Grade 316
- A4 Austenitic Stainless Steel

Code	Type	Length (mm)	Gauge (mm)	Head Colour	Box Qty
NPNW040	Fascia Nail	40	3.10	White	100
NPNW050		50	3.10	White	100
NPNW065		65	3.10	White	100
NPNA040		40	3.10	Anthracite	100
NPNA050		50	3.10	Anthracite	100
NPNA065		65	3.10	Anthracite	100
NPNLB040		40	3.10	Light Oak	100
NPNLB050		50	3.10	Light Oak	100
NPNLB065		65	3.10	Light Oak	100
NPNB040		40	3.10	Brown	100
NPNB050		50	3.10	Brown	100
NPNB065		65	3.10	Brown	100
NPNL040		40	3.10	Black	100
NPNL050		50	3.10	Black	100
NPNL065		65	3.10	Black	100
NPPW025		Fascia Pin	25	2.00	White
NPPW030	30		2.00	White	250
NPPW040	40		2.00	White	250
NPPA030	30		2.00	Anthracite	250
NPPA040	40		2.00	Anthracite	250
NPPLB030	30		2.00	Light Oak	250
NPPLB040	40		2.00	Light Oak	250
NPPB030	30		2.00	Brown	250
NPPB040	40		2.00	Brown	250
NPPL030	30		2.00	Black	250
NPPL040	40		2.00	Black	250

## FASCIA NAILS & PINS IN EUROSLOTTED BAGS

PROVIDED IN EUROSLOTTED BAGS  
JOHN GEORGE BRANDED  
AVAILABLE OFF THE SHELF  
EASILY SALEABLE PACK SIZES  
SOLD IN OUTERS



## FASCIA NAILS & PINS - BAGGED

Image	Type	Size (mm)	Head Colour	BAG Qty
				Outer Qty 5
	Fascia Nail	40	White	50no
		50	White	50no
		65	White	50no
	Fascia Pin	30	White	50no
		40	White	50no

## CLADDING PINS

### CORE USE

- Softwood
- Hardwood
- Ideal for use with UPVC cladding applications



**HEAD**  
PATTERNED TO DIFFRACT SUNLIGHT  
& HELP WITH PAINT ADHESION

**SHANK**  
PROVIDES GOOD GRIP



**A4**

### DURABILITY

- Able to withstand harsh environments
- According to EN 1995-1-1

### MATERIAL

- Grade 316
- A4 Austenitic Stainless Steel

Code	Length (mm)	Gauge (mm)	Box Qty
NPCP030	30	2.00	250





# PREPACKED NAILS IN CLAMS & TUBS

## JOHN GEORGE BRANDED



OVER 400 NAIL LINES  
PROVIDED IN RIGID, CLEAR  
CLAMS & TUBS  
AVAILABLE OFF THE SHELF  
COLOUR CODED LABELS  
EASY TO MERCHANDISE  
SALEABLE BARCODED PACKS  
SOLD IN OUTERS



BRANDED

ALSO AVAILABLE  
TO ORDER WITH

## YOUR OWN BRAND



OVER 400 NAIL LINES  
PROVIDED IN RIGID, CLEAR  
CLAMS & TUBS  
YOUR COMPANY LOGO & DETAILS  
SHORT LEAD TIMES  
ENABLES COST EFFECTIVE  
PROMOTION OF YOUR BUSINESS

YOUR  
OWN  
BRAND







ADAPTABLE MERCHANDISERS AVAILABLE TO SUIT YOUR STOCK RANGE  
SHELF EDGE LABELS & STOCK REORDER CARDS AVAILABLE ON REQUEST  
SALES & MERCHANDISING REPRESENTATIVES ON HAND FOR  
RANGING ADVICE, SUPPORT AND IMPLEMENTATION



## ROUND WIRE NAILS

- Versatile, strong, general purpose nail
- Mostly used to secure floor and roof joists, partitions and heavy duty fencing
- Manufactured to BS1202







BRIGHT (Service Class 1)							GALVANISED (Service Class 3)						
Code	Size (mm)						Code	Size (mm)					
		500g CLAM	1kg CLAM	2.5kg TUB	5kg TUB	10kg TUB			500g CLAM	1kg CLAM	2.5kg TUB	5kg TUB	10kg TUB
		Outer Qty 10	Outer Qty 10	Outer Qty 4	Outer Qty 1	Outer Qty 1			Outer Qty 10	Outer Qty 10	Outer Qty 4	Outer Qty 1	Outer Qty 1
N4RSB	25	✓	✓	✓			N4RSC	25	✓				
	40	✓	✓	✓				40	✓	✓	✓	✓	
	50	✓	✓	✓	✓			50	✓	✓	✓	✓	
	65	✓	✓	✓	✓			65	✓	✓	✓	✓	✓
	75	✓	✓	✓	✓			75	✓	✓	✓	✓	✓
	100	✓	✓	✓	✓	✓		100	✓	✓	✓	✓	✓
	125	✓	✓	✓	✓			125	✓	✓	✓	✓	
150	✓	✓	✓	✓		150	✓	✓	✓	✓			

## OVAL BRAD NAILS

- For general carpentry, the oval shank avoids splitting the wood
- The oval head can be punched below the surface and the small hole filled
- Used for door jambs, floor and skirting boards
- Manufactured to BS1202







BRIGHT (Service Class 1)							GALVANISED (Service Class 3)						
Code	Size (mm)						Code	Size (mm)					
		500g CLAM	1kg CLAM	2.5kg TUB	5kg TUB	10kg TUB			500g CLAM	1kg CLAM	2.5kg TUB	5kg TUB	10kg TUB
		Outer Qty 10	Outer Qty 10	Outer Qty 4	Outer Qty 1	Outer Qty 1			Outer Qty 10	Outer Qty 10	Outer Qty 4	Outer Qty 1	Outer Qty 1
N4OBB	25	✓	✓				N4OBC	25					
	30	✓						30					
	40	✓	✓	✓				40	✓				
	50	✓	✓	✓				50	✓				
	65	✓	✓	✓				65					
	75	✓	✓	✓				75					
	100	✓	✓	✓				100					



### LOST HEAD NAILS

- The small head reduces timber deformation when punched below the surface
- Being easily hidden, it is ideal for all wall, ceiling, flooring and built-in furnishing jobs
- Manufactured to BS1202







BRIGHT (Service Class 1)							SHERARDISED (Service Class 2)						
Code	Size (mm)						Code	Size (mm)					
		500g CLAM	1kg CLAM	2.5kg TUB	5kg TUB	10kg TUB			500g CLAM	1kg CLAM	2.5kg TUB	5kg TUB	10kg TUB
		Outer Qty 10	Outer Qty 10	Outer Qty 4	Outer Qty 1	Outer Qty 1			Outer Qty 10	Outer Qty 10	Outer Qty 4	Outer Qty 1	Outer Qty 1
N4LSB	40	✓	✓	✓			N4LSS	40	✓		✓		
	50	✓	✓	✓				50	✓		✓		
	65	✓	✓	✓	✓			65	✓		✓		
	75	✓	✓	✓				75					

### ANNULAR RING NAILS



- Threaded shank for extra withdrawal resistance
- Used in the making of pallets or fastening floor sheets, MDF and plywood
- Best used when it is unlikely the nail will have to be removed at a later date
- Manufactured to BS1202, ZYP not UKCA marked



UK CA

BRIGHT (Service Class 1)							SHERARDISED (Service Class 2)						
Code	Size (mm)						Code	Size (mm)					
		500g CLAM	1kg CLAM	2.5kg TUB	5kg TUB	10kg TUB			500g CLAM	1kg CLAM	2.5kg TUB	5kg TUB	10kg TUB
		Outer Qty 10	Outer Qty 10	Outer Qty 4	Outer Qty 1	Outer Qty 1			Outer Qty 10	Outer Qty 10	Outer Qty 4	Outer Qty 1	Outer Qty 1
N4ASB	20	✓	✓	✓			N4ASS	20	✓				
	25	✓	✓	✓				25					
	30	✓	✓	✓				30					
	40	✓	✓	✓				40	✓		✓		
	50	✓	✓	✓				50	✓		✓		
	65	✓	✓	✓	✓			65	✓	✓	✓	✓	
	75	✓		✓				75					
	100	✓		✓				100					

#### ZINC & YELLOW PASSIVATED

Code	Size (mm)					
		500g CLAM	1kg CLAM	2.5kg TUB	5kg TUB	10kg TUB
		Outer Qty 10	Outer Qty 10	Outer Qty 4	Outer Qty 1	Outer Qty 1
N4APZ	20					
	30	✓		✓	✓	
	40	✓		✓	✓	
	50	✓		✓		
	65					

### ANNULAR RING SPECIFICATION

Mild steel wire nails with a ring shank, a flat head and a round point.

Head diameter (D) = 2.4 x d

#### OTHER AVAILABLE FINISHES:

- A2 STAINLESS STEEL
- ALUMINIUM
- COPPER
- SILICON BRONZE

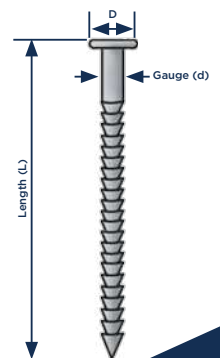

BRANDED



## PANEL PINS

- Ideal for lightweight and decorative jobs, e.g. fixing plywood parts to solid timber
- Sherardised panel pins can be used on external glazing beads
- Manufactured to BS1202



BRIGHT (Service Class 1)						SHERARDISED (Service Class 2)							
Code	Size (mm)	CLAM		TUB			Code	Size (mm)	CLAM		TUB		
		250g	500g	2.5kg	5kg	10kg			250g	500g	2.5kg	5kg	10kg
		Outer Qty 10	Outer Qty 10	Outer Qty 4	Outer Qty 1	Outer Qty 1			Outer Qty 10	Outer Qty 10	Outer Qty 4	Outer Qty 1	Outer Qty 1
N4PSB	15	✓	✓				N4PSS	15		✓			
	20	✓	✓					20	✓	✓			
	25	✓	✓					25	✓	✓			
	30	✓	✓					30	✓	✓			
	40	✓	✓					40	✓	✓			
	50		✓					50					

## VENEER PINS

- Traditionally used in veneer work but can also be used for fixing mouldings
- Manufactured to BS1202



BRIGHT (Service Class 1)							
Code	Size (mm)	CLAM			TUB		
		250g	500g	1kg	2.5kg	5kg	10kg
		Outer Qty 10	Outer Qty 10	Outer Qty 10	Outer Qty 4	Outer Qty 1	Outer Qty 1
N4VSB	15	✓	✓				
	20	✓	✓				
	25	✓	✓				



OVER 400 NAIL LINES  
 PROVIDED IN RIGID, CLEAR CLAMS & TUBS  
 AVAILABLE OFF THE SHELF  
 COLOUR CODED LABELS  
 EASY TO MERCHANDISE  
 SALEABLE BARCODED PACK SIZES  
 SOLD IN OUTERS

### CUT CLASP NAILS

- A traditional cut nail which provides a very strong grip
- Used for rough fixing of timber to brick or blockwork
- Manufactured to BS1202



#### BRIGHT (Service Class 1)

Code	Size (mm)	CLAM			TUB		
		250g	500g	1kg	2.5kg	5kg	10kg
		Outer Qty 10	Outer Qty 10	Outer Qty 10	Outer Qty 4	Outer Qty 1	Outer Qty 1
N4FCB	40		✓				
	50		✓		✓		
	65		✓	✓	✓		
	75		✓	✓	✓		
	100		✓		✓		

### CUT FLOOR BRADS

- Used to fasten floorboards to joists
- The head can easily be punched below the wood surface for a very strong grip
- Manufactured to BS1202



#### BRIGHT (Service Class 1)

Code	Size (mm)	CLAM			TUB		
		250g	500g	1kg	2.5kg	5kg	10kg
		Outer Qty 10	Outer Qty 10	Outer Qty 10	Outer Qty 4	Outer Qty 1	Outer Qty 1
N4FFB	50		✓		✓		
	65		✓		✓		

### SQUARE TWIST NAILS

- For use with joist hangers and restraint straps
- The twisted shank gives superior pull-out resistance
- Manufactured to BS1202



#### GALVANISED (Service Class 3)

#### SHERARDISED (Service Class 2)

Code	Size (mm)	CLAM					TUB				
		500g	1kg	2.5kg	5kg	10kg	500g	1kg	2.5kg	5kg	10kg
		Outer Qty 10	Outer Qty 10	Outer Qty 4	Outer Qty 1	Outer Qty 1	Outer Qty 10	Outer Qty 10	Outer Qty 4	Outer Qty 1	Outer Qty 1
N4SSG	30	✓	✓	✓							
	40	✓	✓	✓							
N4SSS	30	✓	✓	✓							
	40	✓	✓	✓							



BRANDED

## CLOUT NAILS

- A popular general purpose nail
- The larger head stops any pull through on the material
- Applications include securing roofing felt, wire fencing and roofing slates
- Manufactured to BS1202



**UK  
CA**

**GALVANISED (Service Class 3)**

Code	Size (mm)						
		250g CLAM	500g CLAM	1kg CLAM	2.5kg TUB	5kg TUB	10kg TUB
		Outer Qty 10	Outer Qty 10	Outer Qty 10	Outer Qty 4	Outer Qty 1	Outer Qty 1
N4CSG	20		✓				
	25		✓	✓	✓		
	30		✓	✓	✓	✓	
	40		✓	✓	✓	✓	✓
	50		✓	✓	✓	✓	
	65		✓	✓	✓		
	75		✓	✓	✓		
	100		✓	✓	✓		



## ELH CLOUT NAILS

- The extra large head makes them ideal for fastening plastic sheeting and non-ridged roofing felt
- Manufactured to BS1202



**UK  
CA**

**GALVANISED (Service Class 3)**

Code	Size (mm)						
		250g CLAM	500g CLAM	1kg CLAM	2.5kg TUB	5kg TUB	10kg TUB
		Outer Qty 10	Outer Qty 10	Outer Qty 10	Outer Qty 4	Outer Qty 1	Outer Qty 1
N4ESG	13		✓	✓	✓		
	15		✓	✓	✓		
	20		✓	✓	✓	✓	
	25		✓	✓	✓		
	30		✓	✓	✓		
	40		✓		✓	✓	
	50		✓		✓	✓	





### JAGGED SHANK NAILS

- The jagged shank offers superior holding power over a standard shank
- Manufactured to BS1202



GALVANISED (Service Class 3)



Code	Size (mm)						
		250g CLAM	500g CLAM	1kg CLAM	2.5kg TUB	5kg TUB	10kg TUB
		Outer Qty 10	Outer Qty 10	Outer Qty 10	Outer Qty 4	Outer Qty 1	Outer Qty 1
N4JSG	30		✓		✓		
	40		✓		✓		

### INSULATION NAILS

- Most commonly used to fix insulation panels on flat roofs
- The washer head ensures that the panels do not pull through
- Manufactured to BS1202



GALVANISED (Service Class 3)

Code	Size (mm)						
		250g CLAM	500g CLAM	1kg CLAM	2.5kg TUB	5kg TUB	10kg TUB
		Outer Qty 10	Outer Qty 10	Outer Qty 10	Outer Qty 4	Outer Qty 1	Outer Qty 1
N4SLG	125				✓		
	150				✓		
	180				✓		
	200				✓		

### SPRINGHEAD NAILS

- Used for securing galvanised steel sheeting
- The twisted shank gives greater resistance to pullout
- Manufactured to BS1202



GALVANISED (Service Class 3)

Code	Size (mm)						
		250g CLAM	500g CLAM	1kg CLAM	2.5kg TUB	5kg TUB	10kg TUB
		Outer Qty 10	Outer Qty 10	Outer Qty 4	Outer Qty 4	Outer Qty 1	Outer Qty 1
N4SPG	65		✓	✓	✓		
	75				✓		





BRANDED

## CUT POINT STAPLES

- Used in fencing for fixing netting and fencing wire to wooden posts
- Standard cut point for economy
- Manufactured to BS1202



### GALVANISED (Service Class 3)

Code	Size (mm)						
		250g CLAM	500g CLAM	1kg CLAM	2.5kg TUB	5kg TUB	10kg TUB
		Outer Qty 10	Outer Qty 10	Outer Qty 10	Outer Qty 4	Outer Qty 1	Outer Qty 1
N4WSG	15		✓	✓			
	20		✓	✓	✓		
	25		✓	✓	✓		
	30		✓	✓	✓	✓	✓
	40		✓	✓	✓	✓	✓
	50		✓	✓	✓	✓	

## MASONRY NAILS

- Hardened steel nails
- Capable of being driven into masonry, concrete or brickwork
- Manufactured to BS1202

### CSK HEAD



### FLAT HEAD



### BRIGHT ZINC PLATED

Code	Head Type	Size (mm)	
			100no CLAM
			Outer Qty 10
N4MSZ	CSK	25	✓
		30	✓
		40	✓
		50	✓
		60	✓
	FLAT	80	✓
		100	✓

## ONDULINE NAILS

- For use with bitumen based corrugated sheets
- Polished galvanised steel nail with a UV stable seal smart head
- To be used on the crown of the corrugation



### GALVANISED (Service Class 3)

Code	Head Diameter (mm)	Size (mm)	
			50no CLAM Outer Qty 8
N4PEBL	18	65	✓

**RIDGE SCREW & NAIL SETS**  
CAN BE FOUND IN OUR  
**BUILDING PRODUCTS SECTION**



### ALUMINIUM CLOUT NAILS

- Manufactured using aluminium alloy which gives corrosion resistance of nearly 500 times that of bright nails
- Manufactured to BS1202



#### ALUMINIUM



Code	Size (mm)						
		250g CLAM	500g CLAM	1kg TUB	2kg TUB	5kg TUB	10kg TUB
		Outer Qty 10	Outer Qty 10	Outer Qty 4	Outer Qty 4	Outer Qty 1	Outer Qty 1
N4CAB	30			✓			
	38			✓	✓		
	45			✓			
	50			✓	✓		
	65			✓			

### ALUMINIUM TILE PEGS

- Used by roofers for pegging tiles
- Manufactured from aluminium alloy
- Manufactured to BS1202



#### ALUMINIUM

Code	Size (mm)						
		250g CLAM	500g CLAM	1kg TUB	2.5kg TUB	5kg TUB	10kg TUB
		Outer Qty 10	Outer Qty 10	Outer Qty 4	Outer Qty 1	Outer Qty 1	Outer Qty 1
N4TAB	30			✓			
	40			✓			

### COPPER & ALUMINIUM NAILS

Our Copper and Aluminium Clouts and Annular Ring Nails are manufactured according to **BS1202** and **EN 10230-1:1999**

#### TOLERANCES

- L:** ± 0.5d
- d:** ± 0.22mm
- D:** ± 0.05D

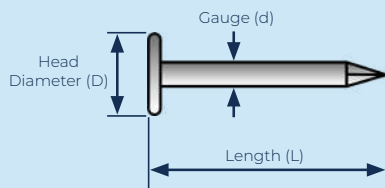

EN 10230-1:1999 TABLE 7

Nominal Diameter/Gauge (mm)	Head Diameter (mm)	Tolerance on Head Diameter (mm)
2.20	7.3	0.36
2.35 / 2.40 / 2.50	7.9	0.40
2.60 / 2.70 / 2.80	8.9	0.45
2.90 / 3.00 / 3.20	9.9	0.50
3.35	11.0	0.53
3.50	11.2	0.56
3.75	11.8	0.59
4.50	13.1	0.66



BRANDED





## COPPER CLOUT NAILS

- Used in roofing and maritime applications
- They act as a rust free fixing for use with tiles, roofing slates or lead
- Manufactured to BS1202



### COPPER

Code	Size (mm)						
		250g CLAM	500g CLAM	1kg CLAM	2.5kg TUB	5kg TUB	10kg TUB
		Outer Qty 10	Outer Qty 10	Outer Qty 4	Outer Qty 4	Outer Qty 1	Outer Qty 1
N4CCB	30			✓	✓		
	35			✓			
	38			✓	✓		
	40			✓			
	50			✓			

## COPPER DISC RIVETS

- Used in the fixing of the slates to help combat wind 'lift'
- Allows slates to bend and recover under wetting and heating cycles



### COPPER

Code	Head Diameter (mm)	Shaft Size (mm)	
			100no CLAM
			Outer Qty 10
R4CDR	19-20	18.5-20 x 2	✓

## COPPERED HARDBOARD PINS

- Used to fix hardboard and other thin boards



### COPPERED

Code	Size (mm)	
		500g CLAM
		Outer Qty 10
N4HSC	20	✓

## COPPER SLATE STRIPS

- Used for repairing slates
- Nail to the batten, slide the slate into place and bend the end of the strap up over the bottom edge of the slate to hold it in place



### COPPER

Code	Size (mm)	
		25no CLAM
		Outer Qty 10
R4CSS	150	✓

## SILICON BRONZE ANN RING NAILS

- Used in the fixing of cedar shingles as the wood can cause staining with iron-based materials
- Resists pull-out stresses and highly corrosion resistant



### SILICON BRONZE





Code	Size (mm)	
		1kg CLAM
		Outer Qty 1
N4ABR	31	✓

### ROUND WIRE NAILS

- Versatile, strong, general purpose nail
- Mostly used to secure floor and roof joists, partitions and heavy duty fencing
- Manufactured to BS1202







UK  
MA

BRIGHT (Service Class 1)						GALVANISED (Service Class 3)							
Code	Size (mm)						Code	Size (mm)					
		500g CLAM	1kg CLAM	2.5kg TUB	5kg TUB	10kg TUB			500g CLAM	1kg CLAM	2.5kg TUB	5kg TUB	10kg TUB
		Outer Qty 10	Outer Qty 10	Outer Qty 4	Outer Qty 1	Outer Qty 1			Outer Qty 10	Outer Qty 10	Outer Qty 4	Outer Qty 1	Outer Qty 1
N9RSB	25	✓	✓	✓			N9RSG	25	✓				
	40	✓	✓	✓				40	✓	✓	✓	✓	
	50	✓	✓	✓	✓	✓		50	✓	✓	✓	✓	✓
	65	✓	✓	✓	✓	✓		65	✓	✓	✓	✓	✓
	75	✓	✓	✓	✓	✓		75	✓	✓	✓	✓	✓
	90							90	✓		✓		
	100	✓	✓	✓	✓	✓		100	✓	✓	✓	✓	✓
	125	✓	✓	✓	✓			125	✓	✓	✓	✓	✓
150	✓	✓	✓	✓		150	✓	✓	✓	✓	✓		

### OVAL BRAD NAILS

- For general carpentry, the oval shank avoids splitting the wood
- The oval head can be punched below the surface and the small hole filled
- Used for door jambs, floor and skirting boards
- Manufactured to BS1202



BRIGHT (Service Class 1)						GALVANISED (Service Class 3)							
Code	Size (mm)						Code	Size (mm)					
		500g CLAM	1kg CLAM	2.5kg TUB	5kg TUB	10kg TUB			500g CLAM	1kg CLAM	2.5kg TUB	5kg TUB	10kg TUB
		Outer Qty 10	Outer Qty 10	Outer Qty 4	Outer Qty 1	Outer Qty 1			Outer Qty 10	Outer Qty 10	Outer Qty 4	Outer Qty 1	Outer Qty 1
N9OBB	25	✓	✓	✓			N9OBG	25					
	30	✓	✓	✓				30					
	40	✓	✓	✓	✓			40	✓				
	50	✓	✓	✓	✓			50	✓				
	65	✓	✓	✓	✓			65	✓				
	75	✓	✓	✓	✓			75	✓				
	100	✓	✓	✓	✓			100					



YOUR  
OWN  
BRAND

## LOST HEAD NAILS

- The small head reduces timber deformation when punched below the surface
- Being easily hidden, it is ideal for all wall, ceiling, flooring and built-in furnishing jobs
- Manufactured to BS1202



BRIGHT (Service Class 1)						SHERARDISED (Service Class 2)					
Code	Size (mm)	500g CLAM		1kg CLAM		2.5kg TUB		5kg TUB		10kg TUB	
		Outer Qty	Outer Qty	Outer Qty	Outer Qty	Outer Qty	Outer Qty	Outer Qty	Outer Qty	Outer Qty	Outer Qty
		10	10	4	1	1	10	10	4	1	1
N9LSB	40	✓	✓	✓							
	50	✓	✓	✓	✓						
	60	✓									
	65	✓	✓	✓	✓	✓					
	75	✓	✓	✓	✓	✓					
N9LSS	40	✓									
	50	✓	✓	✓							
	60										
	65	✓									
	75										

## ANNULAR RING NAILS

- Threaded shank for extra withdrawal resistance
- Used in the making of pallets or fastening floor sheets, MDF and plywood
- Best used when it is unlikely the nail will have to be removed at a later date
- Manufactured to BS1202, ZYP not UKCA marked



UK  
CA

BRIGHT (Service Class 1)						SHERARDISED (Service Class 2)					
Code	Size (mm)	500g CLAM		1kg CLAM		2.5kg TUB		5kg TUB		10kg TUB	
		Outer Qty	Outer Qty	Outer Qty	Outer Qty	Outer Qty	Outer Qty	Outer Qty	Outer Qty	Outer Qty	Outer Qty
		10	10	4	1	1	10	10	4	1	1
N9ASB	20	✓	✓	✓							
	25	✓	✓	✓							
	30	✓	✓	✓							
	40	✓	✓	✓							
	50	✓	✓	✓	✓						
	65	✓	✓	✓	✓	✓					
	75	✓	✓	✓	✓	✓	✓				
	100	✓									
N9ASS	20										
	25	✓									
	30	✓									
	40	✓									
	50	✓									
	65	✓	✓	✓							
	75	✓	✓	✓	✓						
	100	✓									

### ZINC & YELLOW PASSIVATED

Code	Size (mm)	500g CLAM		1kg CLAM		2.5kg TUB		5kg TUB		10kg TUB	
		Outer Qty	Outer Qty	Outer Qty	Outer Qty	Outer Qty	Outer Qty	Outer Qty	Outer Qty	Outer Qty	Outer Qty
		10	10	4	1	1	10	10	4	1	1
N9APZ	20										
	30	✓									
	40	✓									
	50	✓									
	65										

## ANNULAR RING SPECIFICATION

Mild steel wire nails with a ring shank, a flat head and a round point.

Head diameter (D) = 2.4 x d

### OTHER AVAILABLE FINISHES:

- A2 STAINLESS STEEL
- ALUMINIUM
- COPPER
- SILICON BRONZE

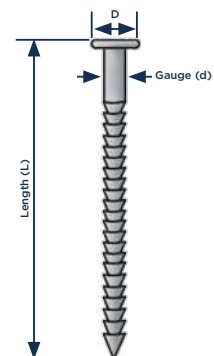







### PANEL PINS

- Ideal for lightweight and decorative jobs, for example fixing plywood parts to solid timber
- Sherardised panel pins can be used on external glazing beads
- Manufactured to BS1202



#### BRIGHT (Service Class 1)

#### SHERARDISED (Service Class 2)

Code	Size (mm)						Code	Size (mm)					
		250g CLAM	500g CLAM	2.5kg TUB	5kg TUB	10kg TUB			250g CLAM	500g CLAM	2.5kg TUB	5kg TUB	10kg TUB
		Outer Qty 10	Outer Qty 10	Outer Qty 4	Outer Qty 1	Outer Qty 1			Outer Qty 10	Outer Qty 10	Outer Qty 4	Outer Qty 1	Outer Qty 1
N9PSB	15	✓	✓				N9PSS	15		✓			
	20	✓	✓					20	✓	✓			
	25	✓	✓					25	✓	✓			
	30	✓	✓					30	✓	✓			
	40	✓	✓					40	✓	✓			
	50	✓	✓					50		✓			

### VENEER PINS

- Traditionally used in veneer work but can also be used for fixing mouldings
- Manufactured to BS1202



#### BRIGHT (Service Class 1)

Code	Size (mm)						
		250g CLAM	500g CLAM	1kg CLAM	2.5kg TUB	5kg TUB	10kg TUB
		Outer Qty 10	Outer Qty 10	Outer Qty 10	Outer Qty 4	Outer Qty 1	Outer Qty 1
N9VSB	15	✓	✓				
	20	✓	✓				
	25	✓	✓				

OVER 400 NAIL LINES  
**PROVIDED IN RIGID, CLEAR CLAMS & TUBS**  
 AVAILABLE WITH YOUR OWN BRAND  
**EASY TO MERCHANDISE**  
 SALEABLE BARCODED PACK SIZES  
**SOLD IN OUTERS**





**YOUR  
OWN  
BRAND**

## CUT CLASP NAILS

- A traditional cut nail which provides a very strong grip
- Used for rough fixing of timber to brick or blockwork
- Manufactured to BS1202



### BRIGHT (Service Class 1)

Code	Size (mm)						
		250g CLAM	500g CLAM	1kg CLAM	2.5kg TUB	5kg TUB	10kg TUB
		Outer Qty 10	Outer Qty 10	Outer Qty 10	Outer Qty 4	Outer Qty 1	Outer Qty 1
N9FCB	40		✓				
	50		✓	✓	✓		
	65		✓	✓	✓		
	75		✓	✓	✓		
	100		✓	✓	✓		

## CUT FLOOR BRADS

- Used to fasten floorboards to joists
- The head can easily be punched below the wood surface for a very strong grip
- Manufactured to BS1202



### BRIGHT (Service Class 1)

Code	Size (mm)						
		250g CLAM	500g CLAM	1kg CLAM	2.5kg TUB	5kg TUB	10kg TUB
		Outer Qty 10	Outer Qty 10	Outer Qty 10	Outer Qty 4	Outer Qty 1	Outer Qty 1
N9FFB	50		✓	✓	✓		
	65		✓	✓	✓		

## SQUARE TWIST NAILS



- For use with joist hangers and restraint straps
- The twisted shank gives superior pull-out resistance
- Manufactured to BS1202



UK  
CA

### GALVANISED (Service Class 3)

### SHERARDISED (Service Class 2)



Code	Size (mm)												
		500g CLAM	1kg CLAM	2.5kg TUB	5kg TUB	10kg TUB	500g CLAM	1kg CLAM	2.5kg TUB	5kg TUB	10kg TUB		
		Outer Qty 10	Outer Qty 10	Outer Qty 4	Outer Qty 1	Outer Qty 1	Outer Qty 10	Outer Qty 10	Outer Qty 4	Outer Qty 1	Outer Qty 1		
N9SSG	30	✓	✓	✓	✓		N9SSS	30	✓	✓	✓	✓	
	40	✓	✓	✓	✓			40	✓	✓	✓		

### CLOUT NAILS

- A popular general purpose nail
- The larger head stops any pull through on the material
- Applications include securing roofing felt, wire fencing and roofing slates
- Manufactured to BS1202



GALVANISED (Service Class 3)



Code	Size (mm)						
		250g CLAM	500g CLAM	1kg CLAM	2.5kg TUB	5kg TUB	10kg TUB
		Outer Qty 10	Outer Qty 10	Outer Qty 10	Outer Qty 4	Outer Qty 1	Outer Qty 1
N9CSG	20			✓	✓		✓
	25		✓	✓	✓		✓
	30		✓	✓	✓	✓	✓
	40		✓	✓	✓	✓	✓
	50		✓	✓	✓	✓	✓
	65		✓	✓	✓	✓	✓
	75		✓	✓	✓		✓

### ELH CLOUT NAILS

- The extra large head makes them ideal for fastening plastic sheeting and non-ridged roofing felt
- Manufactured to BS1202



GALVANISED (Service Class 3)

Code	Size (mm)						
		250g CLAM	500g CLAM	1kg CLAM	2.5kg TUB	5kg TUB	10kg TUB
		Outer Qty 10	Outer Qty 10	Outer Qty 10	Outer Qty 4	Outer Qty 1	Outer Qty 1
N9ESG	13		✓	✓	✓		
	15		✓	✓	✓		
	20		✓	✓	✓	✓	
	25		✓	✓	✓		
	30		✓	✓	✓	✓	✓
	40			✓	✓	✓	✓
	50			✓	✓	✓	✓



YOUR OWN BRAND

## JAGGED SHANK NAILS

- The jagged shank offers superior holding power over a standard shank
- Manufactured to BS1202



### GALVANISED (Service Class 3)



Code	Size (mm)						
		250g CLAM	500g CLAM	1kg CLAM	2.5kg TUB	5kg TUB	10kg TUB
		Outer Qty 10	Outer Qty 10	Outer Qty 10	Outer Qty 4	Outer Qty 1	Outer Qty 1
N9JSG	30		✓	✓	✓		
	40		✓	✓	✓	✓	

## INSULATION NAILS

- Most commonly used to fix insulation panels on flat roofs
- The washer head ensures that the panels do not pull through
- Manufactured to BS1202



### GALVANISED (Service Class 3)

Code	Size (mm)						
		250g CLAM	500g CLAM	1kg CLAM	2.5kg TUB	5kg TUB	10kg TUB
		Outer Qty 10	Outer Qty 10	Outer Qty 4	Outer Qty 4	Outer Qty 1	Outer Qty 1
N9SLG	100			✓			
	125				✓		
	150				✓		
	180				✓		
	200				✓		

## SPRINGHEAD NAILS

- Used for securing galvanised steel sheeting
- The twisted shank gives greater resistance to pullout
- Manufactured to BS1202



### GALVANISED (Service Class 3)

Code	Size (mm)						
		250g CLAM	500g CLAM	1kg CLAM	2.5kg TUB	5kg TUB	10kg TUB
		Outer Qty 10	Outer Qty 10	Outer Qty 4	Outer Qty 4	Outer Qty 1	Outer Qty 1
N9SPG	65		✓	✓	✓		
	75		✓		✓		





### DRIVE SCREWS

- Particularly recommended for fastening hardwood and end-grain wood without splitting
- Easily driven, twist threaded nails
- Manufactured to BS1202



#### GALVANISED (Service Class 3)



Code	Size (mm)						
		250g CLAM	500g CLAM	1kg CLAM	2.5kg TUB	5kg TUB	10kg TUB
		Outer Qty 10	Outer Qty 10	Outer Qty 10	Outer Qty 4	Outer Qty 1	Outer Qty 1
N9DDG	75			✓			
	100			✓			
	125			✓			

### CUT POINT STAPLES

- Used in fencing for fixing netting and fencing wire to wooden posts
- Standard cut point for economy
- Manufactured to BS1202



#### GALVANISED (Service Class 3)



Code	Size (mm)						
		250g CLAM	500g CLAM	1kg CLAM	2.5kg TUB	5kg TUB	10kg TUB
		Outer Qty 10	Outer Qty 10	Outer Qty 10	Outer Qty 4	Outer Qty 1	Outer Qty 1
N9WSG	15		✓	✓			
	20		✓	✓	✓		
	25		✓	✓	✓		
	30		✓	✓	✓	✓	
	40		✓	✓	✓	✓	✓
	50		✓	✓	✓	✓	✓

### BARBED CUT POINT STAPLES

- Galvanised barbed staples with three cuts per point
- The barbs are resistant to traction as the wood dries and cracks



#### GALVANISED (Service Class 3)

Code	Size (mm)						
		500g CLAM	1kg CLAM	2.5kg CLAM	5kg TUB	10kg TUB	20kg TUB
		Outer Qty 10	Outer Qty 10	Outer Qty 1	Outer Qty 1	Outer Qty 1	Outer Qty 1
N9WSGPPB	40					✓	✓

## MASONRY NAILS

- Hardened steel nails
- Capable of being driven into masonry, concrete or brickwork
- Manufactured to BS1202



### BRIGHT ZINC PLATED

Code	Head Type	Size (mm)	100no CLAM	
			Outer Qty	10
N9MSZ	Csk	25	✓	
	Csk	30	✓	
	Csk	40	✓	
	Csk	50	✓	
	Csk	60	✓	
	Flat	70	✓	
	Flat	80	✓	
	Flat	100	✓	

## ONDULINE NAILS

- For use with bitumen based corrugated sheets
- Polished galvanised steel nail with a UV stable seal smart head
- To be used on the crown of the corrugation



### GALVANISED (Service Class 3)

Code	Head Diameter (mm)	Size (mm)	50no CLAM	
			Outer Qty	8
N9PEBL	18	65	✓	

## ALUMINIUM CLOUT NAILS

- Manufactured using aluminium alloy which gives corrosion resistance of nearly 500 times that of bright nails
- Manufactured to BS1202



### ALUMINIUM

Code	Size (mm)	250g CLAM		500g CLAM		1kg TUB		2kg TUB		5kg TUB		10kg TUB	
		Outer Qty		Outer Qty		Outer Qty		Outer Qty		Outer Qty		Outer Qty	
		10	10	10	10	4	4	4	4	1	1	1	1
N9CAB	30					✓							
	38					✓		✓					
	45					✓							
	50					✓		✓					
	65					✓							

## ALUMINIUM TILE PEGS

- Used by roofers for pegging tiles
- Manufactured from aluminium alloy
- Manufactured to BS1202



### ALUMINIUM



Code	Size (mm)	250g CLAM		500g CLAM		1kg TUB		2.5kg TUB		5kg TUB		10kg TUB	
		Outer Qty		Outer Qty		Outer Qty		Outer Qty		Outer Qty		Outer Qty	
		10	10	10	10	4	4	4	4	1	1	1	1
N9TAB	30					✓							
	40					✓							

### COPPER CLOUT NAILS

- Used in roofing and maritime applications
- They act as a rust free fixing for use with tiles, roofing slates or lead



#### COPPER

Code	Size (mm)						
		250g CLAM	500g CLAM	1kg CLAM	2.5kg TUB	5kg TUB	10kg TUB
		Outer Qty 10	Outer Qty 10	Outer Qty 10	Outer Qty 4	Outer Qty 1	Outer Qty 1
N9CCB	30		✓	✓	✓		
	35			✓			
	38		✓	✓	✓		
	40			✓			
	50			✓			

### COPPER DISC RIVETS

- Used in the fixing of the slates to help combat wind 'lift'
- Allows slates to bend and recover under wetting and heating cycles



#### COPPER

Code	Head Diameter (mm)	Shaft Size (mm)		
			100no CLAM	
			Outer Qty 10	
R9CDR	19-20	18.5-20 x 2	✓	

### COPPERED HARDBOARD PINS

- Used to fix hardboard and other thin boards



#### COPPERED

Code	Size (mm)		
		250g CLAM	500g CLAM
		Outer Qty 10	Outer Qty 10
N9HSC	20	✓	✓

### COPPER SLATE STRIPS

- Used for repairing slates
- Nail to the batten, slide the slate into place and bend the end of the strap up over the bottom edge of the slate to hold it in place



#### COPPER

Code	Size (mm)		
		25no CLAM	
		Outer Qty 10	
R9CSS	150	✓	

### SILICON BRONZE ANN RING NAILS

- Used in the fixing of cedar shingles as the wood can cause staining with iron-based materials
- Resists pull-out stresses and highly corrosion resistant



#### SILICON BRONZE

Code	Size (mm)		
		1kg CLAM	
		Outer Qty 1	
N9ABR	31	✓	

## FASCIA NAILS

- Self masking, hammer in fasteners
- Ideal for exposed areas, particularly UPVC
- 3.25mm gauge



A4

### A4 STAINLESS STEEL

Code	Head Colour	Size (mm)	 100no CLAM Outer Qty 5	
N9PN	WHITE	40	✓	
		50	✓	
		65	✓	

## FASCIA PINS

- Self masking, hammer in fasteners
- Ideal for exposed areas, particularly UPVC
- 2.15mm gauge



A4

### A4 STAINLESS STEEL

Code	Head Colour	Size (mm)	 250no CLAM Outer Qty 5	
N9PP	BLACK	30	✓	
		40	✓	
		25	✓	
	WHITE	30	✓	
		40	✓	

Our **A4 stainless steel** fascia nails & pins have high resistance to corrosion and oxidisation and are ideal for uncovered outdoor use.

The shatterproof **polyamide 6 head** is UV stable making them maintenance free and giving great aesthetics over a long life.



YOUR OWN BRAND



2017



1998



1975



1942



1908



# PREPACKED NAILS IN BAGS

## JOHN GEORGE BRANDED



**OVER 250 NAIL LINES**  
PROVIDED IN CLEAR &  
BARCODED BAGS  
**AVAILABLE OFF THE SHELF**  
COLOUR CODED LABELS  
**SOLD IN OUTERS**  
SALEABLE PACK SIZES



ALSO AVAILABLE  
TO ORDER WITH

## YOUR OWN BRAND



**OVER 380 NAIL LINES**  
PROVIDED IN CLEAR &  
**BARCODED BAGS**  
YOUR COMPANY LOGO & DETAILS  
**SHORT LEAD TIMES**  
ENABLES COST EFFECTIVE  
PROMOTION OF YOUR BUSINESS

YOUR  
OWN  
BRAND





**ADAPTABLE MERCHANDISERS AVAILABLE TO SUIT YOUR STOCK RANGE**  
SHELF EDGE LABELS & STOCK REORDER CARDS AVAILABLE ON REQUEST  
**SALES & MERCHANDISING REPRESENTATIVES ON HAND FOR**  
RANGING ADVICE, SUPPORT AND IMPLEMENTATION



## ROUND WIRE NAILS

- Versatile, strong, general purpose nail
- Mostly used to secure floor and roof joists, partitions and heavy duty fencing
- Manufactured to BS1202





BRIGHT (Service Class 1)					GALVANISED (Service Class 3)				
Code	Size (mm)				Code	Size (mm)			
		500g BAG	1kg BAG	2.5kg BAG			500g BAG	1kg BAG	2.5kg BAG
		Outer Qty 10	Outer Qty 10	Outer Qty 5			Outer Qty 10	Outer Qty 10	Outer Qty 5
N2RSB	25	✓		✓	N2RSG	25	✓		✓
	30	✓				30	✓		✓
	40	✓	✓	✓		40	✓	✓	✓
	50	✓	✓	✓		50	✓	✓	✓
	65	✓	✓	✓		65	✓	✓	✓
	75	✓	✓	✓		75	✓	✓	✓
	100	✓	✓	✓		100	✓	✓	✓
	125	✓	✓	✓		125	✓	✓	✓
	150	✓	✓	✓	150	✓	✓	✓	

## OVAL BRAD NAILS

- For general carpentry, the oval shank avoids splitting the wood
- The oval head can be punched below the surface and the small hole filled
- Used for door jambs, floor and skirting boards
- Manufactured to BS1202



BRIGHT (Service Class 1)					GALVANISED (Service Class 3)				
Code	Size (mm)				Code	Size			
		500g BAG	1kg BAG	2.5kg BAG			500g BAG	1kg BAG	2.5kg BAG
		Outer Qty 10	Outer Qty 10	Outer Qty 5			Outer Qty 10	Outer Qty 10	Outer Qty 5
N2OBB	25	✓	✓		N2OBC	25			
	30	✓	✓			30			
	40	✓	✓	✓		40	✓	✓	✓
	50	✓	✓	✓		50	✓	✓	✓
	65	✓	✓	✓		65			
	75	✓		✓		75			
	100	✓		✓		100			

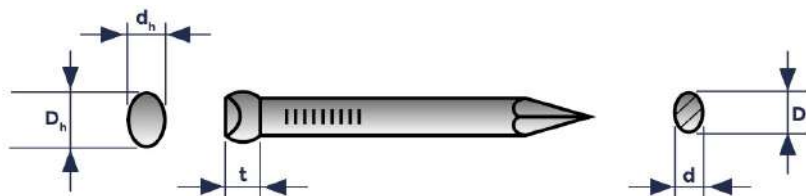

## OVAL BRADS SPECIFICATION



## LOST HEAD NAILS

- The small head reduces timber deformation when punched below the surface
- Being easily hidden, it is ideal for all wall, ceiling, flooring and built-in furnishing jobs
- Manufactured to BS1202





BRIGHT (Service Class 1)					SHERARDISED (Service Class 2)				
Code	Size (mm)				Code	Size (mm)			
		500g BAG	1kg BAG	2.5kg BAG			500g BAG	1kg BAG	2.5kg BAG
		Outer Qty 10	Outer Qty 10	Outer Qty 5			Outer Qty 10	Outer Qty 10	Outer Qty 5
N2LSB	40	✓		✓	N2LSS	40	✓		✓
	50	✓	✓	✓		50	✓		✓
	65	✓	✓	✓		65	✓		✓
	75	✓		✓		75			

## ANNULAR RING NAILS

- Threaded shank for extra withdrawal resistance
- Used in the making of pallets or fastening floor sheets, MDF and plywood
- Best used when it is unlikely the nail will have to be removed at a later date
- Manufactured to BS1202



UK  
CA

BRIGHT (Service Class 1)					SHERARDISED (Service Class 2)				
Code	Size (mm)				Code	Size (mm)			
		500g BAG	1kg BAG	2.5kg BAG			500g BAG	1kg BAG	2.5kg BAG
		Outer Qty 10	Outer Qty 10	Outer Qty 5			Outer Qty 10	Outer Qty 10	Outer Qty 5
N2ASB	20	✓		✓	N2ASS	20			
	25	✓	✓	✓		25			
	30	✓		✓		30			
	40	✓	✓	✓		40	✓	✓	✓
	50	✓	✓	✓		50	✓	✓	✓
	65	✓	✓	✓		65	✓	✓	✓
	75			✓		75			

OVER 250 NAIL LINES  
**PROVIDED IN CLEAR BAGS**  
 AVAILABLE OFF THE SHELF  
**COLOUR CODED LABELS**  
 EASY TO MERCHANDISE  
**SALEABLE BARCODED PACK SIZES**  
 SOLD IN OUTERS



**BRANDED**

## PANEL PINS

- Ideal for lightweight and decorative jobs, e.g. fixing plywood parts to solid timber
- Sherardised panel pins can be used on external glazing beads
- Manufactured to BS1202



### BRIGHT (Service Class 1)

Code	Size (mm)		
		250g BAG	500g BAG
		Outer Qty 10	Outer Qty 10
N2PSB	15	✓	✓
	20	✓	✓
	25	✓	✓
	30	✓	✓
	40	✓	✓
	50	✓	✓

### SHERARDISED (Service Class 2)

Code	Size (mm)		
		250g BAG	500g BAG
		Outer Qty 10	Outer Qty 10
N2PSS	15		
	20	✓	✓
	25	✓	✓
	30	✓	✓
	40	✓	✓
	50	✓	✓

### BRASS

Code	Size (mm)		
		250g BAG	500g BAG
		Outer Qty 1	Outer Qty 1
N2PBB	16	✓	✓
	20	✓	✓
	25	✓	✓
	30	✓	✓
	40	✓	✓

Our **solid brass** panel pins are non-corrosive and long lasting.

They can be used for a variety of jobs, including craft works, decorative jobs, and in marine environments.



## VENEER PINS

- Traditionally used in veneer work but can also be used for fixing mouldings
- Manufactured to BS1202



### BRIGHT (Service Class 1)

Code	Size (mm)		
		250g BAG	500g BAG
		Outer Qty 10	Outer Qty 10
N2LSB	15		✓
	20	✓	✓
	25	✓	✓



**CUT CLASP NAILS**

- A traditional cut nail which provides a very strong grip
- Used for rough fixing of timber to brick or blockwork
- Manufactured to BS1202



**BRIGHT (Service Class 1)**

Code	Size (mm)			
		500g BAG	1kg BAG	2.5kg BAG
		Outer Qty 10	Outer Qty 10	Outer Qty 5
N2FCB	50	✓		✓
	65	✓		✓
	75	✓		✓
	100	✓		✓

**CUT FLOOR BRADS**

- Used to fasten floorboards to joists
- The head can easily be punched below the wood surface for a very strong grip
- Manufactured to BS1202



**BRIGHT (Service Class 1)**

Code	Size (mm)			
		500g BAG	1kg BAG	2.5kg BAG
		Outer Qty 10	Outer Qty 10	Outer Qty 5
N2FFB	50	✓		✓
	65	✓		

**CUT NAILS SPECIFICATION**

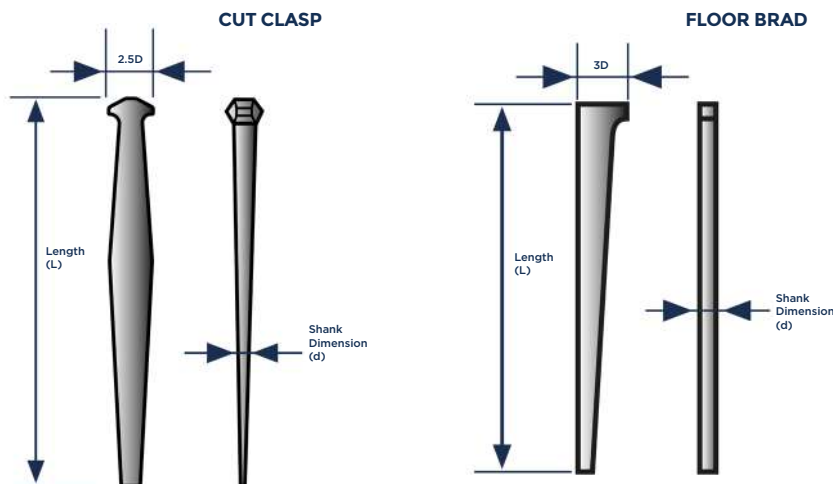

Traditional self colour **cut nails** made from **black rolled steel**. The sides are made bright by the cutting process.

Length/Size (L) (mm)	Gauge (d) (mm)
50	2.65
65	3.00
75	3.35
100	4.00



**BRANDED**

## SQUARE TWIST NAILS

- For or use with joist hangers and restraint straps
- The twisted shank gives superior pull-out resistance
- Manufactured to BS1202



### GALVANISED (Service Class 3)

### SHERARDISED (Service Class 2)

Code	Size (mm)				Code	Size (mm)			
		500g BAG	1kg BAG	2.5kg BAG			500g BAG	1kg BAG	2.5kg BAG
		Outer Qty 10	Outer Qty 10	Outer Qty 5			Outer Qty 10	Outer Qty 10	Outer Qty 5
N2SSG	30	✓	✓	✓	N2SSS	30	✓	✓	✓
	40	✓	✓	✓		40	✓		

## DRIVE SCREWS

- Particularly recommended for fastening hardwood and end-grain wood without splitting
- Easily driven, twist threaded nails
- Manufactured to BS1202



### GALVANISED (Service Class 3)

Code	Size (mm)			
		500g BAG	1kg BAG	2.5kg BAG
		Outer Qty 10	Outer Qty 5	Outer Qty 5
N2DDG	75			✓
	100			✓
	125			✓
	150			✓

## CLOUT NAILS

- A popular general purpose nail
- The larger head stops any pull through on the material
- Applications include securing roofing felt, wire fencing and roofing slates
- Manufactured to BS1202



### GALVANISED (Service Class 3)

Code	Size (mm)			
		500g BAG	1kg BAG	2.5kg BAG
		Outer Qty 10	Outer Qty 10	Outer Qty 5
N2CSG	20	✓		
	25	✓		
	30	✓	✓	✓
	40	✓	✓	✓
	50	✓	✓	✓
	65	✓		✓
	75	✓		✓
	100			✓

**ELH CLOUT NAILS**

- The extra large head makes them ideal for fastening plastic sheeting and non-ridged roofing felt
- Manufactured to BS1202



**GALVANISED (Service Class 3)**

Code	Size (mm)			
		500g BAG	1kg BAG	2.5kg BAG
		Outer Qty 10	Outer Qty 10	Outer Qty 5
N2ESC	13	✓	✓	✓
	15		✓	
	20	✓	✓	✓
	25	✓	✓	✓
	30	✓	✓	✓
	40	✓	✓	✓
	50	✓	✓	✓

**JAGGED SHANK NAILS**

- The jagged shank offers superior holding power over a standard shank
- Manufactured to BS1202



**GALVANISED (Service Class 3)**

Code	Size (mm)			
		500g BAG	1kg BAG	2.5kg BAG
		Outer Qty 10	Outer Qty 10	Outer Qty 5
N2JSC	30	✓	✓	✓
	40	✓	✓	✓

**INSULATION NAILS**

- Most commonly used to fix insulation panels on flat roofs
- The washer head ensures that the panels do not pull through
- Manufactured to BS1202



**GALVANISED (Service Class 3)**

Code	Size (mm)			
		500g BAG	1kg BAG	2.5kg BAG
		Outer Qty 10	Outer Qty 10	Outer Qty 5
N2SLG	100		✓	
	125		✓	
	150		✓	
	180		✓	
	200		✓	



**BRANDED**

## SPRINGHEAD NAILS

- Used for securing galvanised steel sheeting
- The twisted shank gives greater resistance to pullout
- Manufactured to BS1202



### GALVANISED (Service Class 3)

Code	Size (mm)			
		500g BAG	1kg BAG	2.5kg BAG
		Outer Qty 10	Outer Qty 10	Outer Qty 5
N2SPG	65	✓	✓	✓

## CUT POINT STAPLES

- Used in fencing for fixing netting and fencing wire to wooden posts
- Standard cut point for economy
- Manufactured to BS1202



### GALVANISED (Service Class 3)

Code	Size (mm)			
		500g BAG	1kg BAG	2.5kg BAG
		Outer Qty 10	Outer Qty 10	Outer Qty 5
N2WSG	15	✓		✓
	20	✓	✓	✓
	25	✓	✓	✓
	30	✓	✓	✓
	40	✓	✓	✓
	50	✓		✓

## COPPERED HARDBOARD PINS

- Used to fix hardboard and other thin boards



### COPPERED



Code	Size (mm)			
		250g BAG	500g BAG	1kg BAG
		Outer Qty 10	Outer Qty 10	Outer Qty 10
N2HSC	20	✓	✓	



## ROUND WIRE NAILS

- Versatile, strong, general purpose nail
- Mostly used to secure floor and roof joists, partitions and heavy duty fencing
- Manufactured to BS1202





BRIGHT (Service Class 1)					GALVANISED (Service Class 3)				
Code	Size (mm)				Code	Size (mm)			
		500g BAG	1kg BAG	2.5kg BAG			500g BAG	1kg BAG	2.5kg BAG
		Outer Qty 10	Outer Qty 10	Outer Qty 5			Outer Qty 10	Outer Qty 10	Outer Qty 5
N7RSB	25	✓	✓	✓	N7RSG	25	✓	✓	✓
	30	✓	✓	✓		30	✓	✓	✓
	40	✓	✓	✓		40	✓	✓	✓
	50	✓	✓	✓		50	✓	✓	✓
	65	✓	✓	✓		65	✓	✓	✓
	75	✓	✓	✓		75	✓	✓	✓
	100	✓	✓	✓		100	✓	✓	✓
	125	✓	✓	✓		125	✓	✓	✓
	150	✓	✓	✓		150	✓	✓	✓
200				200	✓	✓	✓		

## OVAL BRAD NAILS

- For general carpentry, the oval shank avoids splitting the wood
- The oval head can be punched below the surface and the small hole filled
- Used for door jambs, floor and skirting boards
- Manufactured to BS1202



BRIGHT (Service Class 1)					GALVANISED (Service Class 3)				
Code	Size (mm)				Code	Size (mm)			
		500g BAG	1kg BAG	2.5kg BAG			500g BAG	1kg BAG	2.5kg BAG
		Outer Qty 10	Outer Qty 10	Outer Qty 5			Outer Qty 10	Outer Qty 10	Outer Qty 5
N7OBB	25	✓	✓	✓	N7OBC	25			
	30	✓	✓	✓		30			
	40	✓	✓	✓		40	✓	✓	✓
	50	✓	✓	✓		50	✓	✓	✓
	65	✓	✓	✓		65	✓	✓	✓
	75	✓	✓	✓		75			
	100	✓	✓	✓		100			
	125	✓	✓	✓		125			
	150	✓		✓		150			

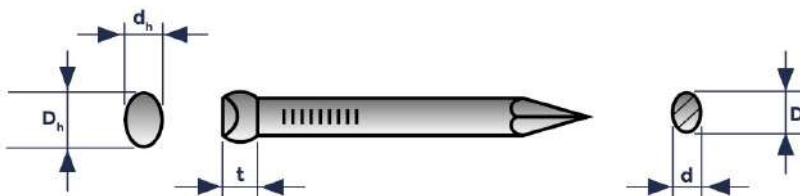

## OVAL BRADS SPECIFICATION



## LOST HEAD NAILS

- The small head reduces timber deformation when punched below the surface
- Being easily hidden, it is ideal for all wall, ceiling, flooring and built-in furnishing jobs
- Manufactured to BS1202







BRIGHT (Service Class 1)					SHERARDISED (Service Class 2)				
Code	Size (mm)				Code	Size (mm)			
		500g BAG	1kg BAG	2.5kg BAG			500g BAG	1kg BAG	2.5kg BAG
		Outer Qty 10	Outer Qty 10	Outer Qty 5			Outer Qty 10	Outer Qty 10	Outer Qty 5
N7LSB	40	✓	✓	✓	N7LSS	40	✓	✓	✓
	50	✓	✓	✓		50	✓	✓	✓
	65	✓	✓	✓		65	✓	✓	✓
	75	✓	✓	✓		75	✓	✓	✓

## ANNULAR RING NAILS

- Threaded shank for extra withdrawal resistance
- Used in the making of pallets or fastening floor sheets, MDF and plywood
- Best used when it is unlikely the nail will have to be removed at a later date
- Manufactured to BS1202, ZYP not UKCA marked



UK  
CA

BRIGHT (Service Class 1)					SHERARDISED (Service Class 2)				
Code	Size (mm)				Code	Size (mm)			
		500g BAG	1kg BAG	2.5kg BAG			500g BAG	1kg BAG	2.5kg BAG
		Outer Qty 10	Outer Qty 10	Outer Qty 5			Outer Qty 10	Outer Qty 10	Outer Qty 5
N7ASB	20	✓	✓	✓	N7ASS	20	✓		
	25	✓	✓	✓		25	✓	✓	✓
	30	✓	✓	✓		30			
	40	✓	✓	✓		40	✓	✓	✓
	50	✓	✓	✓		50	✓	✓	✓
	65	✓	✓	✓		65	✓	✓	✓
	75	✓	✓	✓		75	✓	✓	✓
	100	✓	✓	✓		100	✓	✓	✓
GALVANISED (Service Class 3)					ZINC & YELLOW PASSIVATED				
Code	Size (mm)				Code	Size (mm)			
		500g BAG	1kg BAG	2.5kg BAG			500g BAG	1kg BAG	2.5kg BAG
		Outer Qty 10	Outer Qty 10	Outer Qty 5			Outer Qty 10	Outer Qty 10	Outer Qty 5
N7ASG	20				N7APZ	20			
	25					25			
	30					30	✓	✓	✓
	40					40	✓	✓	✓
	50					50	✓	✓	✓
	65	✓	✓	✓		65			
	75					75	✓	✓	✓
	100					100			

YOUR  
OWN  
BRAND



## PANEL PINS

- Ideal for lightweight and decorative jobs, e.g. fixing plywood parts to solid timber
- Sherardised panel pins can be used on external glazing beads
- Manufactured to BS1202



### BRIGHT (Service Class 1)

### SHERARDISED (Service Class 2)

Code	Size (mm)			Code	Size (mm)		
		250g BAG	500g BAG			250g BAG	500g BAG
		Outer Qty 10	Outer Qty 10			Outer Qty 10	Outer Qty 10
N7PSB	15	✓	✓	N7PSS	15		
	20	✓	✓		20	✓	✓
	25	✓	✓		25	✓	✓
	30	✓	✓		30	✓	✓
	40	✓	✓		40	✓	✓
	50	✓	✓		50	✓	✓

## VENEER PINS

- Traditionally used in veneer work but can also be used for fixing mouldings
- Manufactured to BS1202



### BRIGHT (Service Class 1)

Code	Size (mm)		
		250g BAG	500g BAG
		Outer Qty 10	Outer Qty 10
N7VSB	15	✓	✓
	20	✓	✓
	25	✓	✓

## CUT CLASP NAILS

- A traditional cut nail which provides a very strong grip
- Used for rough fixing of timber to brick or blockwork
- Manufactured to BS1202



### BRIGHT (Service Class 1)

Code	Size (mm)			
		500g BAG	1kg BAG	2.5kg BAG
		Outer Qty 10	Outer Qty 10	Outer Qty 5
N7FCB	40	✓	✓	✓
	50	✓	✓	✓
	65	✓	✓	✓
	75	✓	✓	✓
	100	✓	✓	✓

YOUR  
OWN  
BRAND

## CUT FLOOR BRADS

- Used to fasten floorboards to joists
- The head can easily be punched below the wood surface for a very strong grip
- Manufactured to BS1202



BRIGHT (Service Class 1)

Code	Size (mm)			
		500g BAG	1kg BAG	2.5kg BAG
		Outer Qty 10	Outer Qty 10	Outer Qty 5
N7FFB	50	✓	✓	✓
	65	✓	✓	✓

## SQUARE TWIST NAILS

- For or use with joist hangers and restraint straps
- The twisted shank gives superior pull-out resistance
- Manufactured to BS1202



UK  
CA

GALVANISED (Service Class 3)

SHERARDISED (Service Class 2)

Code	Size (mm)				Code	Size (mm)			
		500g BAG	1kg BAG	2.5kg BAG			500g BAG	1kg BAG	2.5kg BAG
		Outer Qty 10	Outer Qty 10	Outer Qty 5			Outer Qty 10	Outer Qty 10	Outer Qty 5
N7SSG	30	✓	✓	✓	N7SSS	30	✓	✓	✓
	40	✓	✓	✓		40	✓	✓	✓

## DRIVE SCREWS

- Particularly recommended for fastening hardwood and end-grain wood without splitting
- Easily driven, twist threaded nails
- Manufactured to BS1202



GALVANISED (Service Class 3)

Code	Size (mm)			
		500g BAG	1kg BAG	2.5kg BAG
		Outer Qty 10	Outer Qty 10	Outer Qty 5
N7DDG	75	✓	✓	✓
	100	✓	✓	✓
	115	✓	✓	✓
	125	✓	✓	✓
	150	✓	✓	✓

YOUR  
OWN  
BRAND



**CLOUT NAILS**

- A popular general purpose nail
- The larger head stops any pull through on the material
- Applications include securing roofing felt, wire fencing and roofing slates
- Manufactured to BS1202



**GALVANISED (Service Class 3)**

Code	Size (mm)			
		500g BAG	1kg BAG	2.5kg BAG
		Outer Qty 10	Outer Qty 10	Outer Qty 5
N7CSC	20	✓	✓	✓
	25	✓	✓	✓
	30	✓	✓	✓
	40	✓	✓	✓
	50	✓	✓	✓
	65	✓	✓	✓
	75	✓	✓	✓
100	✓	✓	✓	

**ELH CLOUT NAILS**

- The extra large head makes them ideal for fastening plastic sheeting and non-ridged roofing felt
- Manufactured to BS1202



**GALVANISED (Service Class 3)**

Code	Size (mm)			
		500g BAG	1kg BAG	2.5kg BAG
		Outer Qty 10	Outer Qty 10	Outer Qty 5
N7ESC	13	✓	✓	✓
	15	✓	✓	✓
	20	✓	✓	✓
	25	✓	✓	✓
	30	✓	✓	✓
	40	✓	✓	✓
	50	✓	✓	✓



**YOUR OWN BRAND**

## JAGGED SHANK NAILS

- The jagged shank offers superior holding power over a standard shank
- Manufactured to BS1202



GALVANISED (Service Class 3)

Code	Size (mm)			
		500g BAC	1kg BAC	2.5kg BAC
		Outer Qty 10	Outer Qty 10	Outer Qty 5
N7JSG	30	✓	✓	✓
	40	✓	✓	✓

## INSULATION NAILS

- Most commonly used to fix insulation panels on flat roofs
- The washer head ensures that the panels do not pull through
- Manufactured to BS1202



GALVANISED (Service Class 3)

Code	Size (mm)			
		500g BAC	1kg BAC	2.5kg BAC
		Outer Qty 10	Outer Qty 10	Outer Qty 5
N7SLG	100	✓	✓	✓
	125	✓	✓	✓
	150	✓	✓	✓
	180	✓	✓	✓
	200		✓	

## SPRINGHEAD NAILS

- Used for securing galvanised steel sheeting
- The twisted shank gives greater resistance to pullout
- Manufactured to BS1202



GALVANISED (Service Class 3)

Code	Size (mm)			
		500g BAC	1kg BAC	2.5kg BAC
		Outer Qty 10	Outer Qty 10	Outer Qty 5
N7SPG	65	✓	✓	✓

**CUT POINT STAPLES**

- Used in fencing for fixing netting and fencing wire to wooden posts
- Standard cut point for economy
- Manufactured to BS1202



**GALVANISED (Service Class 3)**

Code	Size (mm)			
		500g BAG	1kg BAG	2.5kg BAG
		Outer Qty 10	Outer Qty 10	Outer Qty 5
N7WSG	15	✓	✓	✓
	20	✓	✓	✓
	25	✓	✓	✓
	30	✓	✓	✓
	40	✓	✓	✓
	50	✓	✓	✓

**COPPERED HARDBOARD PINS**

- Used to fix hardboard and other thin boards



**COPPERED**

Code	Size (mm)		
		250g BAG	500g BAG
		Outer Qty 10	Outer Qty 10
N7HSC	20	✓	✓

OVER 380 NAIL LINES  
YOUR LOGO & YOUR COMPANY DETAILS  
SHORT LEAD TIMES  
ENABLES COST EFFECTIVE PROMOTION  
OF YOUR BUSINESS



**YOUR OWN BRAND**

## PREPACKED NAILS IN TUBS



OUR MOST POPULAR FERROUS LINES IN 20KG TUBS  
YOUR LOGO & COMPANY DETAILS  
**SHORT LEAD TIMES**  
ENABLES COST EFFECTIVE PROMOTION  
OF YOUR BUSINESS



### ROUND WIRE NAILS

- Versatile, strong, general purpose nail
- Mostly used to secure floor and roof joists, partitions and heavy duty fencing
- Manufactured to BS1202



BRIGHT (Service Class 1)			GALVANISED (Service Class 3)		
Code	Size (mm)	20kg TUB	Code	Size (mm)	20kg TUB
		Outer Qty 1			Outer Qty 1
N7RSBT	40		N7RSGT	40	✓
	50	✓		50	✓
	65	✓		65	✓
	75	✓		75	✓
	100	✓		100	✓
	125			125	✓
	150		150	✓	

### CLOUT NAILS

- A popular general purpose nail
- The larger head stops any pull through on the material
- Manufactured to BS1202



#### GALVANISED (Service Class 3)

Code	Size (mm)	20kg TUB
		Outer Qty 1
N7CSGT	30	✓
	40	✓
	50	✓

### CUT POINT STAPLES

- Used in fencing for fixing netting and fencing wire to wooden posts
- Standard cut point for economy
- Manufactured to BS1202



#### GALVANISED (Service Class 3)

Code	Size (mm)	20kg TUB
		Outer Qty 1
N7WSGT	30	✓
	40	✓

YOUR  
OWN  
BRAND



## PREPACKED NAILS, STAPLES & PINS IN HANGING CLAMS

JOHN GEORGE BRANDED NAILS & PINS  
PROVIDED IN CLEAR EUROSLOTTED CLAMS  
AVAILABLE OFF THE SHELF  
IDEAL FOR SMALL JOBS & DIY  
SOLD IN OUTERS



### NAILS & STAPLES

Type	Code	Finish	Size (mm)		
				Outer Qty 5	CLAMPAQ Weight
ROUND WIRE NAILS	N6RSB	BRIGHT	25	150g	
			30	150g	
			40	150g	
			50	150g	
			65	150g	
			75	150g	
			100	150g	
			125	150g	
	N6RSG	GALV	25	125g	
			30	125g	
			40	125g	
			50	125g	
			65	125g	
			75	125g	
			100	125g	
OVAL BRAD NAILS	N6OBB	BRIGHT	25	150g	
			30	150g	
			40	150g	
LOST HEAD NAILS	N6LSB	BRIGHT	40	150g	
			50	150g	
			65	150g	
ANNULAR RING NAILS	N6ASB	BRIGHT	25	150g	
			40	150g	
			50	150g	
			65	150g	
SQUARE TWIST NAILS	N6SSC	GALV	30	100g	
			40	100g	
			50	100g	
CLOUT NAILS	N6CSG	GALV	13	100g	
			20	100g	
			30	100g	
ELH CLOUT NAILS	N6ESG	GALV	40	100g	
			30	100g	
			40	100g	
JAGGED SHANK NAILS	N6JSG	GALV	30	100g	
			40	100g	
CUT POINT STAPLES	N6WSC	GALV	15	100g	
			20	100g	
			30	100g	
			40	100g	



### PINS

Type	Code	Finish	Size (mm)		
				Outer Qty 10	CLAMPAQ Weight
PANEL PINS	N6PSB	BRIGHT	15	75g	
			20	75g	
			25	75g	
			30	75g	
			40	75g	
	N6PSS	SHER	20	50g	
			25	50g	
			30	50g	
			40	50g	
	N6PBB	BRASS	16	50g	
20			50g		
25			50g		
30			50g		
N6PST	A2 STAINLESS STEEL	20	50g		
		25	50g		
		30	50g		
		40	50g		
VENEER PINS	N6VSB	BRIGHT	20	50g	
			25	50g	
HARDBOARD PINS	N6HSC	COPPERED	15	30g	



CLAMPAQ SCREWS AND SUNDRIES CAN BE FOUND IN OUR SCREWS AND SUNDRIES SECTIONS!

## MASONRY NAILS

Type	Code	Finish	Size (mm)		
				Outer Qty 10	CLAMPAQ Qty
CSK HEAD	N6FPZ2		BZP	25 x 2.5	25no
				30 x 2.5	25no
				40 x 2.5	20no
				50 x 2.5	20no
				60 x 2.5	15no
FLAT HEAD	N6FPZ3		BZP	50 x 3.5	10no
				60 x 3.5	7no
				70 x 3.5	7no
				80 x 3.5	7no
				90 x 3.5	6no
				100 x 3.5	5no

## FASCIA NAILS & PINS

Type	Code	Finish	Size (mm)		
				Outer Qty 10	CLAMPAQ Qty
FASCIA NAIL	N6PNW	A4 STAINLESS STEEL	40	12no	
			50	10no	
			65	8no	
FASCIA PIN	N6PPW		30	40no	
			40	30no	

## CLIPS, PINS & TACKS

Type	Code	Size/Finish		
			Outer Qty 10	CLAMPAQ Qty/Wgt
BLUED CUT TACKS	N6CTB		13mm	50g
			15mm	50g
			20mm	50g
			25mm	50g
BRASSED DRAWING PINS	N6DPB		10mm	25no
UPHOLSTERY NAILS	N6UNA		ANTIQUE	20no
	N6UNB		BRASSED	20no
BLACK GIMP PINS	N6GPL		13mm	25g
BRASSED ESCUTCHEON PINS	N6EPB		15mm	25g
FLAT CABLE CLIPS	N6CCF		For 1.5mm	15no
			For 2.5mm	15no
ROUND CABLE CLIPS	N6CCR		For 4mm	20no
			For 5mm	20no
			For 7mm	15no
BRASSED PICTURE HOOKS WITH PINS	N6PHB		No 1	8no
			No 2	5no
			No 3	2no
HARDWALL HOOKS	N6PHH		-	2no
BRASSED PICTURE PINS	N6PHP		PLAIN	20no
BRASSED PICTURE WIRE	N6PHW		3.5 Metres	30g

## SUPER DRIVE PROFESSIONAL WOODSCREWS

Our No. 1 selling woodscrew!  
SUITABLE FOR USE WITH AN IMPACT DRIVER

### MATERIAL

- Manufactured from hardened steel for high torque loads
- Zinc & Yellow Passivated for indoor and limited outdoor use



UK  
CA

### BOXES

Code	Finish	Gauge (mm)	Length (mm)	Box Qty	Outer Qty
SPD30012	ZINC & YELLOW	3.0	12	200	18000
SPD30020		3.0	20	200	18000
SPD30025		3.0	25	200	10000
SPD35012		3.5	12	200	18000
SPD35016		3.5	16	200	18000
SPD35020		3.5	20	200	10000
SPD35025		3.5	25	200	8400
SPD35030		3.5	30	200	8400
SPD35040		3.5	40	200	4800
SPD35050		3.5	50	200	4800
SPD40020		4.0	20	200	8400
SPD40025		4.0	25	200	8400
SPD40030		4.0	30	200	4800
SPD40035		4.0	35	200	4800
SPD40040		4.0	40	200	4800
SPD40045		4.0	45	200	4800
SPD40050		4.0	50	200	2800
SPD40060		4.0	60	200	2800
SPD40070		4.0	70	100	2400
SPD40080		4.0	80	100	2400
SPD50030		5.0	30	200	4800
SPD50040		5.0	40	200	2800
SPD50050		5.0	50	200	2800
SPD50060		5.0	60	100	2400
SPD50070		5.0	70	100	1400
SPD50080		5.0	80	100	1400
SPD50090		5.0	90	100	1400
SPD50100		5.0	100	100	1400
SPD60050		6.0	50	100	2400
SPD60060		6.0	60	100	1400
SPD60070		6.0	70	100	1400
SPD60080		6.0	80	100	1400
SPD60090	6.0	90	100	1400	
SPD60100	6.0	100	100	1400	
SPD60120	6.0	120	50	600	
SPD60130	6.0	130	50	600	
SPD60150	6.0	150	50	600	
SPD60180	6.0	180	50	400	
SPD60200	6.0	200	50	400	

### TUBS

Code	Finish	Gauge (mm)	Length (mm)	Tub Qty	Outer Qty
SPDT40030	ZINC & YELLOW	4.0	30	1000	4 Tubs
SPDT40040		4.0	40	850	4 Tubs
SPDT40050		4.0	50	640	4 Tubs
SPDT40070		4.0	70	320	4 Tubs
SPDT50050		5.0	50	450	4 Tubs
SPDT50060		5.0	60	350	4 Tubs
SPDT50070		5.0	70	300	4 Tubs
SPDT50080		5.0	80	260	4 Tubs
SPDT50090		5.0	90	240	4 Tubs
SPDT50100		5.0	100	200	4 Tubs
SPDT60060		6.0	60	220	4 Tubs
SPDT60070		6.0	70	200	4 Tubs
SPDT60080		6.0	80	180	4 Tubs
SPDT60100		6.0	100	150	4 Tubs

# SUPER DRIVE

### HEAD TYPE

POZI RECESSED, DOUBLE COUNTERSUNK RIBBED HEAD TO GIVE A FLUSH FINISH

### THREAD

FULLY THREADED UNDER 70MM FOR MAX. HOLDING POWER  
KNURLED THREAD FOR INCREASED DRIVE SPEED  
40° THREAD ANGLE FOR MAX. PULLOUT RESISTANCE

### POINT

TYPE 17 FOR EASIER STARTING IN ALL TIMBERS



### CORE USE

- Softwood
- Hardwood
- MDF
- Chipboard



### OTHER APPLICATIONS

- Thin Sheet Metal
- Plastics



## PREPACKED SUPER DRIVE

ALSO AVAILABLE IN  
EUROSLOTTED  
CLAMPAQ HANGING  
PACKS  
FOR SMALLER JOBS

BAR CODED & EASY  
TO MERCHANDISE

SEE OUR PREPACKED  
SCREWS SECTION





# SUPERDRIVE

## PRECISION WOODSCREWS



### IMMEDIATE START

#### Type 17 Point

Designed especially for wood, this long sharp point pierces the timber and captures chips.

#### Straight into Hardwood

The type 17 point gives ease of start up, even in more dense, close grained hardwoods.

#### No Pilot Hole Required

The type 17 point reduces the chance of splitting the wood so no need for a pilot hole.



### FASTER INSERTION

#### Wax Coating

A synthetic, anti-friction coating which not only increases drive speed but also aids against corrosion.

#### Knurled Thread

The grooves in the thread cut through the wood fibres more quickly and enable a faster insertion.



### MAXIMUM PULL OUT RESISTANCE

#### 40° Thread Angle

Designed to give a secure hold and maximum pull out resistance.

#### Single Thread

For strength in position and higher pull out retention than a twinthread screw.



# SUPER

### C1022 LOW CARBON STEEL

Forged from high quality low carbon steel and case hardened to 0.1mm depth; giving a balance of strength and ductility.

#### CORE USE

- Softwood
- Hardwood
- MDF
- Chipboard



#### OTHER APPLICATIONS

- Thin Sheet Metal
- Plastics



**ZINC & YELLOW PASSIVATED**

For all internal and limited external applications

UK  
CA





**Super Drive - our N° 1 selling woodscrew.**

**This fully threaded screw (70mm and under) has been developed to meet the needs of a technologically advanced building and DIY trade.**

**Made from high quality, low carbon steel, this woodscrew balances strength and ductility, as well as ease of driving and holding power.**

**PERFECT PRECISION FOR ALL TIMBER PROJECTS.**

### **LESS TORQUE REQUIRED**

Super Drive's type 17 point, wax coating and knurled thread all reduce the torque required - fast, easy and multipurpose!

### **SECURE FLUSH FINISH**

#### **Ribbed Double Countersunk**

The ribs cut the countersunk hole for the screw whilst it's being inserted - so no need for a separate drill bit.

#### **Deep Recessed Pozi Head**

Industry standard pozi thread which is less likely to cam-out than a Phillips/Cross recessed head.



### **MAXIMUM HOLDING POWER**

#### **Fully Threaded**

Up to and including 70mm - perfect when joining two materials together and a very tight hold is necessary.



**DRIVE** HIGH PERFORMANCE PROFESSIONAL WOODSCREWS



**FOR SIZES SEE Pg. 61**

Suitable for use with an **IMPACT DRIVER**



**FREE BIT**  
IN EVERY PACK





# IMPACT

## WOOD SCREWS

**Our part-threaded woodscrew is designed for easy insertion into all types of timber.**

The double type 17 point gouges through the wood as the screw is inserted - making it ideal for use with an IMPACT driver and negating the need for pilot holes in most cases.

The milling shank helps clear the hole of wood chips and speeds up insertion further still. With its part threaded shank, IMPACT spins freely inside the outermost piece of wood and draw the inner piece tight against it. Topped off with a double countersunk head, IMPACT leaves you with a secure hold and a flush, professional finish.

### ZINC & YELLOW PASSIVATED

For all internal and limited external applications

### POZI RECESSED HEAD

For an industry standard fit



**FREE DRIVER BIT IN EVERY PACK**



FOR SIZES SEE



**Pg. 66**





## C1022 LOW CARBON STEEL

Forged from high quality low carbon steel and case hardened to 0.1mm depth; giving a balance of strength and ductility.

### CORE USE

- Softwood
- Hardwood
- MDF
- Chipboard



### OTHER APPLICATIONS

- Thin Sheet Metal
- Plastics



UK  
CA



**DOUBLE TYPE  
17 POINT**  
Immediate start  
in all timbers

**MILLING SHANK**  
Helps clear hole  
in fixture

**PART THREADED  
FROM 40MM**  
To eliminate jacking  
of fixture

**RIBBED DOUBLE  
COUNTERSUNK**  
For a flush finish

**ALSO  
AVAILABLE  
IN HANDY  
TUBS**



Suitable  
for use  
with an  
**IMPACT  
DRIVER**





# IMPACT WOOD SCREWS

## HEAD TYPE

POZI RECESSED, DOUBLE COUNTERSUNK RIBBED HEAD TO GIVE A FLUSH FINISH

## THREAD

PART THREADED FROM 40MM TO ELIMINATE JACKING OF FIXTURE  
MILLING SHANK TO HELP CLEAR HOLE IN FIXTURE

## POINT

DOUBLE TYPE 17 FROM 25MM FOR EASIER STARTING IN ALL TIMBERS



### CORE USE

- Softwood
- Hardwood
- MDF
- Chipboard



### OTHER APPLICATIONS

- Thin Sheet Metal
- Plastics



FREE DRIVER BIT  
INCLUDED IN EVERY BOX



IDEAL FOR USE WITH  
IMPACT DRIVERS

## IMPACT WOODSCREWS

Our part threaded woodscrew (from 40mm) with a milling shank. Suitable for use with an Impact driver.

### MATERIAL

- Manufactured from hardened steel for high torque loads
- Zinc & Yellow Passivated for indoor and limited outdoor use



UK  
CA

### BOXES

Code	Finish	Gauge (mm)	Length (mm)	Milling Shank	Box Qty	Outer Qty
SIMZ35012	ZINC & YELLOW	3.5	12		200	10000
SIMZ35016		3.5	16		200	10000
SIMZ35020		3.5	20		200	10000
SIMZ35025		3.5	25		200	4800
SIMZ35030		3.5	30		200	4800
SIMZ35040		3.5	40	✓	200	4800
SIMZ35050		3.5	50	✓	200	4800
SIMZ40020		4.0	20		200	4800
SIMZ40025		4.0	25		200	4800
SIMZ40030		4.0	30		200	4800
SIMZ40040		4.0	40		200	4800
SIMZ40045		4.0	45	✓	200	4800
SIMZ40050		4.0	50	✓	200	2800
SIMZ40060		4.0	60	✓	200	2800
SIMZ40070		4.0	70	✓	100	2400
SIMZ40075		4.0	75	✓	100	2400
SIMZ40080		4.0	80	✓	100	2400
SIMZ50030		5.0	30		200	4800
SIMZ50040		5.0	40		200	2800
SIMZ50050		5.0	50	✓	200	2800
SIMZ50060	5.0	60	✓	100	2400	
SIMZ50070	5.0	70	✓	100	1400	
SIMZ50075	5.0	75	✓	100	1400	
SIMZ50080	5.0	80	✓	100	1400	
SIMZ50090	5.0	90	✓	100	1400	
SIMZ50100	5.0	100	✓	100	1400	
SIMZ60050	6.0	50	✓	100	2400	
SIMZ60060	6.0	60	✓	100	1400	
SIMZ60070	6.0	70	✓	100	1400	
SIMZ60080	6.0	80	✓	100	1400	
SIMZ60090	6.0	90	✓	100	1400	
SIMZ60100	6.0	100	✓	100	1400	
SIMZ60120	6.0	120	✓	50	600	
SIMZ60130	6.0	130	✓	50	600	
SIMZ60150	6.0	150	✓	50	600	
SIMZ60180	6.0	180	✓	50	350	
SIMZ60200	6.0	200	✓	50	350	

### TUBS

Code	Finish	Gauge (mm)	Length (mm)	Milling Shank	Tub Qty	Outer Qty
SIMZT35025	ZINC & YELLOW	3.5	25		2000	4 Tubs
SIMZT35030		3.5	30		1800	4 Tubs
SIMZT40025		4.0	25		1700	4 Tubs
SIMZT40030		4.0	30		1500	4 Tubs
SIMZT40040		4.0	40		1200	4 Tubs
SIMZT40050		4.0	50	✓	800	4 Tubs
SIMZT40060		4.0	60	✓	600	4 Tubs
SIMZT40070		4.0	70	✓	500	4 Tubs
SIMZT40080		4.0	80	✓	400	4 Tubs
SIMZT50040		5.0	40		800	4 Tubs
SIMZT50050		5.0	50	✓	600	4 Tubs
SIMZT50060		5.0	60	✓	400	4 Tubs
SIMZT50070		5.0	70	✓	375	4 Tubs
SIMZT50075		5.0	75	✓	360	4 Tubs
SIMZT50080		5.0	80	✓	350	4 Tubs
SIMZT50090		5.0	90	✓	325	4 Tubs
SIMZT50100		5.0	100	✓	300	4 Tubs
SIMZT60100		6.0	100	✓	225	4 Tubs



# Twinthread

ALSO AVAILABLE  
PREPACKED  
SEE OUR CLAMPAQ  
SCREWS SECTION



### HEAD TYPE

- COUNTERSUNK
- ROUND HEAD

### FINISHES

- BRIGHT ZINC PLATED (BZP)
- BLACK ORGANIC

### THREAD

TWINTHREAD

PILOT HOLE RECOMMENDED



## TWINTHREAD WOODSCREWS COUNTERSUNK

### CORE USE

- Softwood
- Hardwood



**THREAD**  
TWINTHREAD ARE EASY  
TO DRIVE IN SO IDEAL FOR  
HARDWOOD

**HEAD**  
POZI RECESSED  
COUNTERSUNK

### MATERIAL

- Non-alloy steel rods in accordance with EN10083-2
- Declared performance to EN 14592:2008+A1:2012
- For indoor use



UK  
CA

## TWINTHREAD WOODSCREWS ROUND HEAD

### CORE USE

- Softwood
- Hardwood



**THREAD**  
TWINTHREAD ARE EASY  
TO DRIVE IN SO IDEAL FOR  
HARDWOOD

**HEAD**  
ROUND,  
POZI RECESSED

### MATERIAL

- Non-alloy steel rods in accordance with EN10083-2
- Declared performance to EN 14592:2008+A1:2012
- For indoor use



UK  
CA

Code	Finish	Gauge	Length	Box Qty	Outer Qty	
SOHZ0405	BZP	4	1/2"	200	10000	
SOHZ040625		4	5/8"	200	10000	
SOHZ06050		6	1/2"	200	10000	
SOHZ060625		6	5/8"	200	10000	
SOHZ06075		6	3/4"	200	10000	
SOHZ061		6	1"	200	4800	
SOHZ06125		6	1 1/4"	200	4800	
SOHZ080625		8	5/8"	200	10000	
SOHZ08075		8	3/4"	200	4800	
SOHZ081		8	1"	200	4800	
SOHZ08125		8	1 1/4"	200	4800	
SOHZ0815		8	1 1/2"	200	4800	
SOHZ082		8	2"	200	2800	
SOHZ10075		10	3/4"	200	4800	
SOHZ101		10	1"	200	4800	
SOHZ10125		10	1 1/4"	200	4800	
SOHZ1015		10	1 1/2"	200	2800	
SOHZ102		10	2"	200	2800	
SOHB0605		BLACK ORGANIC	6	1/2"	200	10000
SOHB060625			6	5/8"	200	10000
SOHB06075	6		3/4"	200	10000	
SOHB061	6		1"	200	4800	
SOHB06125	6		1 1/4"	200	4800	
SOHB0805	8		1/2"	200	10000	
SOHB080625	8		5/8"	200	10000	
SOHB08075	8		3/4"	200	4800	
SOHB081	8		1"	200	4800	
SOHB08125	8		1 1/4"	200	4800	
SOHB0815	8		1 1/2"	200	4800	
SOHB082	8		2"	200	2800	
SOHB10075	10		3/4"	200	4800	
SOHB101	10		1"	200	4800	
SOHB10125	10		1 1/4"	200	4800	
SOHB1015	10		1 1/2"	200	2800	
SOHB102	10		2"	200	2800	
SOHB1215	12		1 1/2"	200	2800	
SOHB122	12		2"	200	2400	

Code	Finish	Gauge	Length	Box Qty	Outer Qty
SFHZ0405	BZP	4	1/2"	200	10000
SFHZ040625		4	5/8"	200	10000
SFHZ04075		4	3/4"	200	10000
SFHZ041		4	1"	200	10000
SFHZ0605		6	1/2"	200	10000
SFHZ060625		6	5/8"	200	10000
SFHZ06075		6	3/4"	200	10000
SFHZ061		6	1"	200	4800
SFHZ06125		6	1 1/4"	200	4800
SFHZ0615		6	1 1/2"	200	4800
SFHZ06175		6	1 3/4"	200	4800
SFHZ062		6	2"	200	4800
SFHZ07075		7	3/4"	200	10000
SFHZ071		7	1"	200	4800
SFHZ07125		7	1 1/4"	200	4800
SFHZ0715		7	1 1/2"	200	4800
SFHZ0805		8	1/2"	200	10000
SFHZ080625		8	5/8"	200	10000
SFHZ08075		8	3/4"	200	4800
SFHZ081		8	1"	200	4800
SFHZ08125	8	1 1/4"	200	4800	
SFHZ0815	8	1 1/2"	200	4800	
SFHZ08175	8	1 3/4"	200	4800	
SFHZ082	8	2"	200	2800	
SFHZ08225	8	2 1/4"	200	2800	
SFHZ0825	8	2 1/2"	200	2800	
SFHZ083	8	3"	100	2400	
SFHZ10075	10	3/4"	200	4800	
SFHZ101	10	1"	200	4800	
SFHZ10125	10	1 1/4"	200	4800	
SFHZ1015	10	1 1/2"	200	2800	
SFHZ10175	10	1 3/4"	200	2800	
SFHZ102	10	2"	200	2800	
SFHZ10225	10	2 1/4"	100	2400	
SFHZ1025	10	2 1/2"	100	2400	
SFHZ103	10	3"	100	2400	
SFHZ1035	10	3 1/2"	100	1400	
SFHZ104	10	4"	100	1400	
SFHZ12125	12	1 1/4"	200	2800	
SFHZ1215	12	1 1/2"	200	2800	
SFHZ122	12	2"	100	2400	
SFHZ1225	12	2 1/2"	100	1400	
SFHZ123	12	3"	100	1400	
SFHZ1235	12	3 1/2"	100	1400	
SFHZ124	12	4"	100	1400	
SFHB08125	BLACK ORGANIC	8	1 1/4"	200	4800
SFHB0815		8	1 1/2"	200	4800
SFHB10125		10	1 1/4"	200	4800
SFHB1015		10	1 1/2"	200	2800

# Universal

## HEAD TYPE

COUNTERSUNK

## FINISHES

- ZINC & YELLOW (ZYP)
- A2 STAINLESS STEEL

## THREAD

SINGLE THREAD



- ESSENTIAL, EVERYDAY SCREWS WHICH ARE USED FOR A WIDE VARIETY OF APPLICATIONS IN SOFTWOOD AND CHIPBOARD
- ZINC & YELLOW PASSIVATED ARE IDEAL FOR USE WITH POWERTOOLS
- A2 STAINLESS STEEL CAN ALSO BE USED IN HARDWOOD AND OUTDOORS

PILOT HOLE RECOMMENDED

## UNIVERSAL WOODSCREWS A2 STAINLESS STEEL

### CORE USE

- Softwood
- Hardwood
- Chipboard



### HEAD

POZI RECESSED HEAD

### THREAD

SINGLE THREAD



A2

### MATERIAL

- A2 Stainless Steel for high corrosion resistance

Code	Finish	Gauge (mm)	Length (mm)	Box Qty	Outer Qty
SCTR35020	A2 STAINLESS STEEL	3.5	20	200	4800
SCTR35025		3.5	25	200	4800
SCTR35030		3.5	30	200	4800
SCTR35040		3.5	40	200	4800
SCTR40020		4.0	20	200	4800
SCTR40025		4.0	25	200	4800
SCTR40030		4.0	30	200	4800
SCTR40040		4.0	40	200	4800
SCTR40050		4.0	50	200	2800
SCTR40060		4.0	60	200	2800
SCTR40070		4.0	70	100	2400
SCTR50025		5.0	25	200	4800
SCTR50030		5.0	30	200	4800
SCTR50040		5.0	40	200	2800
SCTR50050		5.0	50	200	2800
SCTR50060		5.0	60	100	2400
SCTR50070		5.0	70	100	1400
SCTR50080		5.0	80	100	1400
SCTR50090		5.0	90	100	1400
SCTR50100		5.0	100	100	1400
SCTR60040		6.0	40	200	2800
SCTR60050		6.0	50	100	2400
SCTR60060		6.0	60	100	1400
SCTR60070		6.0	70	100	1400
SCTR60080		6.0	80	100	1400
SCTR60090		6.0	90	100	1400
SCTR60100		6.0	100	100	1400

## UNIVERSAL WOODSCREWS ZYP

### CORE USE

- Softwood
- Chipboard



### MATERIAL

- Zinc & Yellow Passivated with wax lubricant coating for quicker driving and ideal for use with powertools

### HEAD

POZI RECESSED COUNTERSUNK

### THREAD

SINGLE THREAD



UK CA

Code	Finish	Gauge (mm)	Length (mm)	Box Qty	Outer Qty	
SIHZ300130	ZINC & YELLOW		13	200	10000	
SIHZ300160			16	200	10000	
SIHZ300200			20	200	10000	
SIHZ300250			25	200	10000	
SIHZ300300			30	200	10000	
SIHZ350130				13	200	10000
SIHZ350160				16	200	10000
SIHZ350200				20	200	10000
SIHZ350250				25	200	4800
SIHZ350300				30	200	4800
SIHZ350350				35	200	4800
SIHZ350400				40	200	4800
SIHZ350450				45	200	4800
SIHZ350500				50	200	4800
SIHZ400130				13	200	10000
SIHZ400160				16	200	10000
SIHZ400200				20	200	4800
SIHZ400250				25	200	4800
SIHZ400300				30	200	4800
SIHZ400350				35	200	4800
SIHZ400400				40	200	4800
SIHZ400450				45	200	4800
SIHZ400500				50	200	2800
SIHZ400600				60	200	2800
SIHZ400700				70	100	2400
SIHZ400800				80	100	2400
SIHZ450250				25	200	4800
SIHZ450300				30	200	4800
SIHZ450350				35	200	4800
SIHZ450400				40	200	4800
SIHZ450450			45	200	2800	
SIHZ450500			50	200	2800	
SIHZ450600			60	200	2800	
SIHZ450700			70	100	2400	
SIHZ500200			20	200	4800	
SIHZ500250			25	200	4800	
SIHZ500300			30	200	4800	
SIHZ500350			35	200	4800	
SIHZ500400			40	200	2800	
SIHZ500450			45	200	2800	
SIHZ500500			50	200	2800	
SIHZ500600			60	100	2400	
SIHZ500700			70	100	1400	
SIHZ500800			80	100	1400	
SIHZ500900			90	100	1400	
SIHZ501000			100	100	1400	
SIHZ501200			120	50	600	
SIHZ501500			150	50	600	
SIHZ600400			40	200	2800	
SIHZ600500			50	100	2400	
SIHZ600600			60	100	1400	
SIHZ600700			70	100	1400	
SIHZ600800			80	100	1400	
SIHZ600900			90	100	1400	
SIHZ601000			100	100	1400	
SIHZ601200			120	50	600	
SIHZ601300			130	50	600	
SIHZ601500			150	50	600	

# Drywall

## HEAD TYPE

- BUGLE HEAD
- WAFER HEAD

## FINISHES

- BLACK PHOSPHATE
- BRIGHT ZINC PLATED (BZP)

## THREAD

- FINE THREAD
- COARSE THREAD

- AVAILABLE IN BULK BOXES, SMALL BOXES AND COLLATED
- DESIGNED FOR INDOOR USE ONLY AND WITH TWO FINISHES
- COARSE THREAD ARE IDEAL FOR TIMBER BATTENS, FINE THREAD FOR METAL OR TIMBER BATTENS

FREE DRIVER BIT WITH EVERY BULK BOX



## DRYWALL SCREWS BLACK PHOSPHATE

### CORE USE

- Primarily used for fastening drywall, plywood or insulation board to steel studs
- Fine thread for timber or metal battens

### MATERIAL

- Non-alloy steel rods in accordance with EN10083-2
- Declared performance to EN 14566:2008+A1:2009
- For indoor use

**HEAD**  
PHILLIPS RECESSED, BUGLE HEAD TO REDUCE TEARING OF THE PLASTERBOARD

**THREAD**  
FINE THREAD WHICH IS SELF THREADING

**POINT**  
SHARP TO PIERCE THE DRYWALL



### BULK BOXES

Code	Finish	Thread Type	Gauge (mm)	Length (mm)	Box Qty	Outer Qty
SDBB350250	BLACK PHOSPHATE	Fine	3.5	25	1000	12000
SDBB350320		Fine	3.5	32	1000	12000
SDBB350380		Fine	3.5	38	1000	8000
SDBB350410		Fine	3.5	42	1000	8000
SDBB350450		Fine	3.5	45	1000	6000
SDBB350510		Fine	3.5	50	1000	6000
SDBB350570		Fine	3.5	57	500	4000
SDBB420650		Fine	4.2	65	500	4000
SDBB420700		Fine	4.2	70	500	3000
SDBB420750		Fine	4.2	75	500	3000
SDBB48100		Fine	4.8	100	200	1600

### BOXES OF 200

Code	Finish	Thread Type	Gauge (mm)	Length (mm)	Box Qty	Outer Qty
SDHB35025	BLACK PHOSPHATE	Fine	3.5	25	200	4800
SDHB35032		Fine	3.5	32	200	4800
SDHB35038		Fine	3.5	38	200	4800
SDHB35041		Fine	3.5	42	200	4800
SDHB35045		Fine	3.5	45	200	4800
SDHB35051		Fine	3.5	50	200	4800
SDHB35057		Fine	3.5	57	200	2800
SDHB42065		Fine	4.2	65	200	2800
SDHB42070		Fine	4.2	70	200	2800
SDHB42075		Fine	4.2	75	200	2800

### CORE USE

- Primarily used for fastening drywall, plywood or insulation board to steel studs
- Coarse thread for timber battens

### MATERIAL

- Non-alloy steel rods in accordance with EN10083-2
- Declared performance to EN 14566:2008+A1:2009
- For indoor use

**HEAD**  
PHILLIPS RECESSED, BUGLE HEAD TO REDUCE TEARING OF THE PLASTERBOARD

**THREAD**  
COARSE THREAD TO GRIP THE WOOD

**POINT**  
SHARP TO PIERCE THE DRYWALL



### BULK BOXES

Code	Finish	Thread Type	Gauge (mm)	Length (mm)	Box Qty	Outer Qty
SDBC350250	BLACK PHOSPHATE	Coarse	3.5	25	1000	12000
SDBC350320		Coarse	3.5	32	1000	12000
SDBC350380		Coarse	3.5	38	1000	8000
SDBC350410		Coarse	3.5	42	1000	8000
SDBC350510		Coarse	3.5	50	1000	6000
SDBC420650		Coarse	4.2	65	500	4000
SDBC420750		Coarse	4.2	75	500	3000
SDBC48100		Coarse	4.8	100	200	1600

## DRYWALL SCREWS BZP

### CORE USE

- Primarily used for fastening drywall, plywood or insulation board to steel studs
- Fine thread for timber or metal battens

### MATERIAL

- Non-alloy steel rods in accordance with EN10083-2
- Declared performance to EN 14566:2008+A1:2009
- For indoor use

**HEAD**  
PHILLIPS RECESSED, BUGLE HEAD TO REDUCE TEARING OF THE PLASTERBOARD

**THREAD**  
FINE THREAD WHICH ARE SELF THREADING

**POINT**  
SHARP TO PIERCE THE DRYWALL



### BULK BOXES

Code	Finish	Thread Type	Gauge (mm)	Length (mm)	Box Qty	Outer Qty
SDBZ35025	BZP	Fine	3.5	25	1000	12000
SDBZ35032		Fine	3.5	32	1000	12000
SDBZ35038		Fine	3.5	38	1000	8000
SDBZ35041		Fine	3.5	42	1000	8000
SDBZ35045		Fine	3.5	45	1000	6000
SDBZ35051		Fine	3.5	50	1000	6000
SDBZ35057		Fine	3.5	57	500	4000
SDBZ42065		Fine	4.2	65	500	4000
SDBZ42075		Fine	4.2	75	500	3000
SDBZ48100		Fine	4.8	100	200	1600
SDBZ48125		Fine	4.8	125	100	600
SDBZ48150		Fine	4.8	150	100	600

### BOXES OF 200

Code	Finish	Thread Type	Gauge (mm)	Length (mm)	Box Qty	Outer Qty
SDHZ35025	BZP	Fine	3.5	25	200	4800
SDHZ35032		Fine	3.5	32	200	4800
SDHZ35038		Fine	3.5	38	200	4800
SDHZ35041		Fine	3.5	42	200	4800
SDHZ35045		Fine	3.5	45	200	4800
SDHZ35051		Fine	3.5	50	200	4800
SDHZ35057		Fine	3.5	57	200	2800
SDHZ42065		Fine	4.2	65	200	2800
SDHZ42075		Fine	4.2	75	200	2800



# Drywall

## COLLATED DRYWALL BZP

Our collated drywall screws are connected to each other by a holding strip - the screw passes through the strip as it is driven into the timber.

### CORE USE

- Primarily used for fastening drywall, plywood or insulation board to steel studs
- Fine thread for timber or metal battens

### MATERIAL

- Non-alloy steel rods in accordance with EN10083-2
- Declared performance to EN 14566:2008+A1:2009
- For indoor use

**HEAD**  
PHILLIPS RECESSED, BUGLE HEAD TO REDUCE TEARING OF THE PLASTERBOARD

**THREAD**  
FINE THREAD WHICH IS SELF THREADING

**POINT**  
SHARP TO PIERCE THE DRYWALL



Code	Finish	Thread Type	Gauge (mm)	Length (mm)	Box Qty	Outer Qty
SDLZ35025	BZP	Fine	3.5	25	1000	10000
SDLZ35032		Fine	3.5	32	1000	10000
SDLZ35035		Fine	3.5	35	1000	10000
SDLZ35038		Fine	3.5	38	1000	10000
SDLZ35042		Fine	3.5	42	1000	10000
SDLZ35045		Fine	3.5	45	1000	10000
SDLZ35050		Fine	3.5	50	1000	10000
SDLZ35055		Fine	3.5	55	1000	10000

## COLLATED DRYWALL BLACK PHOSPHATE

Our collated drywall screws are connected to each other by a holding strip - the screw passes through the strip as it is driven into the timber.

### CORE USE

- Primarily used for fastening drywall, plywood or insulation board to steel studs
- Coarse thread for timber battens

### MATERIAL

- Non-alloy steel rods in accordance with EN10083-2
- Declared performance to EN 14566:2008+A1:2009
- For indoor use

**HEAD**  
PHILLIPS RECESSED, BUGLE HEAD TO REDUCE TEARING OF THE PLASTERBOARD

**THREAD**  
COARSE THREAD TO GRIP THE WOOD AND PULL THE DRYWALL AGAINST THE STUDS

**POINT**  
SHARP TO PIERCE THE DRYWALL



Code	Finish	Thread Type	Gauge (mm)	Length (mm)	Box Qty	Outer Qty
SDL39025	BLACK PHOSPHATE	Coarse	3.5	25	1000	10000
SDL39032		Coarse	3.5	32	1000	10000
SDL39035		Coarse	3.5	35	1000	10000
SDL39038		Coarse	3.5	38	1000	10000
SDL39042		Coarse	3.5	42	1000	10000
SDL39045		Coarse	3.5	45	1000	10000
SDL39050		Coarse	3.5	50	1000	10000
SDL39055		Coarse	3.5	55	1000	10000

## COLLATED DRYWALLS

- Easy to use
- Minimal force required
- Compatible with most screw guns

## SELF DRILLING DRYWALL SCREWS

### CORE USE

- Primarily used for fastening drywall, plywood or insulation board to steel studs
- Fine thread for timber or metal battens
- No pilot hole required

### MATERIAL

- Non-alloy steel rods in accordance with EN10083-2
- Declared performance to EN 14566:2008+A1:2009
- For indoor use

**HEAD**  
PHILLIPS RECESSED, BUGLE HEAD TO REDUCE TEARING OF THE PLASTERBOARD

**THREAD**  
FINE THREAD WHICH IS SELF THREADING

**POINT**  
SELF DRILLING - NO NEED FOR PILOT HOLE



Code	Finish	Thread Type	Gauge (mm)	Length (mm)	Box Qty	Outer Qty
SDSZ35025	BZP	Fine	3.5	25	1000	12000
SDSZ35032		Fine	3.5	32	1000	12000
SDSZ35038		Fine	3.5	38	1000	8000
SDSZ35042		Fine	3.5	42	1000	8000
SDSZ35050		Fine	3.5	50	1000	6000
SDSZ42065		Fine	4.2	65	500	4000
SDSZ42075		Fine	4.2	75	500	3000

## WAFER HEAD DRYWALL SCREWS

### CORE USE

- Designed for fitting dry linings to steel framework without the need for pilot holes
- Fine thread for timber or metal battens

### MATERIAL

- Non-alloy steel rods in accordance with EN10083-2
- Declared performance to EN 14566:2008+A1:2009
- For indoor use

**HEAD**  
PHILLIPS RECESSED, WAFER HEAD PROVIDES A LARGER BEARING SURFACE SO IT CAN SIT FLUSH IN SOFT MATERIALS

**THREAD**  
FINE THREAD - SELF THREADING

**POINT**  
SELF DRILLING - NO PILOT HOLE NEEDED



Code	Finish	Thread Type	Gauge (mm)	Length (mm)	Box Qty	Outer Qty
STWB014	BZP	Fine	4.2	14	1000	12000
STWH014		Fine	4.2	14	200	4800

## WAFER HEAD SELF DRILLING DRYWALLS

Our **Wafer Head Drywalls** have a fine thread and a self drilling point.

**OUR RECOMMENDATION** is to use them for thick gauge metal studwork (over 0.7mm thick).



# Decking

- AVAILABLE IN BOXES AND TUBS (GREEN ORGANIC ONLY)
- DESIGNED FOR OUTDOOR USE AND WITH TWO FINISHES
- SUITABLE FOR DECKING, FENCING AND SHEDS
- PART THREADED ON 2½" AND ABOVE TO ELIMINATE JACKING

**HEAD TYPE**

POZI RECESSED  
COUNTERSUNK

**FINISHES**

- GREEN ORGANIC
- A2 STAINLESS STEEL

**THREAD**

SINGLE THREAD



## DECKING SCREWS A2 STAINLESS STEEL

**CORE USE**

- Softwood
- Hardwood: pilothole needed



**HEAD**  
POZI RECESSED  
DOUBLE COUNTERSUNK  
FOR A FLUSH FINISH

**THREAD**  
SINGLE THREAD -  
IDEAL FOR USE WITH  
POWER TOOLS

**MATERIAL**

- A2 Stainless Steel: for high corrosion resistance

**POINT**  
TYPE 17 FOR  
EASIER START  
IN ALL TIMBERS



Code	Finish	Gauge	Length	Box Qty	Outer Qty
SDTST082	A2 STAINLESS STEEL	8	2"	200	2800
SDTST0825		8	2½"	200	2800
SDTST083		8	3"	200	2800

## DECKING SCREWS GREEN ORGANIC

**CORE USE**

- Softwood



**MATERIAL**

- Magni green organic coating gives 1000 hours salt spray corrosion resistance

**HEAD**  
POZI RECESSED DOUBLE  
COUNTERSUNK FOR A  
FLUSH FINISH

**THREAD**  
SINGLE THREAD  
IDEAL FOR USE WITH  
POWER TOOLS



**BOXES**

Code	Finish	Gauge	Length	Box Qty	Outer Qty
SDTY082	GREEN ORGANIC	8	2"	200	2800
SDTY0825		8	2½"	200	2800
SDTY083		8	3"	200	2800
SDTY103		10	3"	100	2800
SDTY104		10	4"	100	2800

**TUBS**

Code	Finish	Gauge	Length	Tub Qty	Outer Qty
SDTY182	GREEN ORGANIC	8	2"	1000	2 Tubs
SDTY1825		8	2½"	1000	2 Tubs
SDTY183		8	3"	1000	2 Tubs

## SCREW METRIC CONVERSIONS & GAUGE EQUIVALENTS

Length (inches)	Equivalent (mm)	Nearest Metric (mm)
½	12.7	13
5/8	15.9	15
¾	19.1	20
1	25.4	25
1¼	31.8	30
1½	38.1	40
1¾	44.5	45
2	50.8	50
2¼	57.2	60
2½	63.5	65
3	76.2	80
3½	88.9	90
4	101.6	100
5	127.0	125
6	152.4	150
8	203.2	200
10	254.0	250

Screw Gauge (g)	Equivalent (mm)	Nearest Metric (mm)
4	2.74	3.0
5	3.10	3.0
6	3.45	3.5
7	3.81	4.0
8	4.17	4.0
9	4.52	4.5
10	4.88	5.0
12	5.59	6.0



# TIMBERFAST

## BUILD TO LAST STRUCTURAL SCREWS

Our Timberfast structural screws are designed for outdoor timber to timber applications. With their Type 17 self-drilling point, no pilot hole is required and they can be used with impact drivers. They have a knurled coarse thread which cuts through the wood and a milling shank to help clear the hole in the timber.

We offer a hex head to allow added torque or a flush head for a flat finish. Colour options include a traditional black ruspert coating or a green organic finish - both giving high corrosion resistance in an outdoor setting. Driver bits (8mm A/F hex drivers or T30 recess) are included in all pack sizes, even in the small tubes. If you do need extra driver bits, we provide the hex drivers separately as well.

So whatever outdoor timber structure you are building, you can choose the right Timberfast head type, colour or pack size which suits the job!

Timberfast - for building, decking, fencing and more!



FOR SIZES SEE  
Pg. 74

### BLACK RUSPERT OR GREEN ORGANIC COATED

High corrosion resistance





✓ **SELF-DRILLING POINT**

(Type 17 point and sawtooth thread)  
Easy start in all timbers and no pilot hole required

✓ **MILLING SHANK**

Helps clear hole in fixture

✓ **40° THREAD ANGLE**

To give a secure hold and maximum pull out resistance

✓ **HARDENED STEEL**

(C10B21 steel – case depth 0.1mm)  
High quality, low carbon steel with added Boron to improve hardenability

✓ **HEX OR FLUSH HEAD**

Traditional or flat finish options

✓ **AVAILABLE IN BOXES, TUBS OR TUBES**

So you can choose the right size pack for the job

Suitable for use with an

**IMPACT DRIVER**



**FREE DRIVER BIT**

WITH EVERY PACK



**UK  
CA**



## HEAD TYPE

- HEX HEAD - 8MM A/F WITH A 12.5MM FLANGE WASHER
- FLUSH HEAD - T30 RECESS 15MM DIAMETER

## FINISHES

- BLACK RUSPERT
- GREEN ORGANIC

## THREAD

KNURLED WITH A MILLING SHANK

## POINT

TYPE 17 SELF DRILLING



**FREE DRIVER BIT INCLUDED IN EVERY PACK**

## CORE USE

- Hardened outdoor structural screws for use with impact drivers
- Softwood

## MATERIAL

- Non-alloy steel rods in accordance with EN10083-2
- C10B21 Low Carbon Steel
- Declared performance to EN 14592:2008+A1:2012
- Black ruspert has a 3 layer high grade protective coating
- Magni green organic coating gives 1000 hours salt spray corrosion resistance



**IDEAL FOR USE WITH IMPACT DRIVERS**



# TIMBERFAST

## BUILD TO LAST

### TIMBERFAST HEX HEAD



UK  
CA

Code	Finish	Size (mm)	Pack Size	Outer Qty
STF5006065	BLACK RUSPERT COATING	6.3 x 65	Box of 50	900
STF5006090		6.3 x 90	Box of 50	800
STF5006100		6.3 x 100	Box of 50	800
STF5006125		6.3 x 125	Box of 50	600
STF5006140		6.3 x 140	Box of 50	600
STF5006150		6.3 x 150	Box of 50	600
STF5006190		6.3 x 190	Box of 50	400
STF5006200		6.3 x 200	Box of 50	400
STF5006240		6.3 x 240	Box of 50	400
STF5006250		6.3 x 250	Box of 50	400
STFT06090		6.3 x 90	Tub of 250	500
STFT06100		6.3 x 100	Tub of 250	500
STFT06140		6.3 x 140	Tub of 250	500
STFT06150		6.3 x 150	Tub of 250	500
STF1006090		6.3 x 90	Tube of 10	5 Tubes
STF1006100		6.3 x 100	Tube of 10	5 Tubes
STF1006125		6.3 x 125	Tube of 10	5 Tubes
STF1006140		6.3 x 140	Tube of 10	5 Tubes
STF1006150		6.3 x 150	Tube of 10	5 Tubes
STF1006190		6.3 x 190	Tube of 10	5 Tubes
STF1006200		6.3 x 200	Tube of 10	5 Tubes
STF1006240		6.3 x 240	Tube of 10	5 Tubes
STF1006250		6.3 x 250	Tube of 10	5 Tubes
STF2506065		6.3 x 65	Tube of 25	5 Tubes
STF2506090		6.3 x 90	Tube of 25	5 Tubes
STF2506100		6.3 x 100	Tube of 25	5 Tubes
STF2506125		6.3 x 125	Tube of 25	5 Tubes
STF2506140		6.3 x 140	Tube of 25	5 Tubes
STF2506150		6.3 x 150	Tube of 25	5 Tubes



UK  
CA

### TIMBERFAST FLUSH HEAD



UK  
CA

Code	Finish	Size (mm)	Pack Size	Outer Qty
STFFHG5006100	GREEN ORGANIC	6.3 x 100	Box of 50	800
STFFHG5006125		6.3 x 125	Box of 50	600
STFFHG5006150		6.3 x 150	Box of 50	600
STFFHG5006200		6.3 x 200	Box of 50	400
STFFHG5006250		6.3 x 250	Box of 50	300
STFFHG1006100		6.3 x 100	Tube of 10	5 Tubes
STFFHG1006125		6.3 x 125	Tube of 10	5 Tubes
STFFHG1006150		6.3 x 150	Tube of 10	5 Tubes
STFFHG1006200		6.3 x 200	Tube of 10	5 Tubes
STFFHG1006250		6.3 x 250	Tube of 10	5 Tubes

Code	Finish	Size (mm)	Pack Size	Outer Qty
STFHC5006065	GREEN ORGANIC	6.3 x 65	Box of 50	900
STFHC5006090		6.3 x 90	Box of 50	800
STFHC5006100		6.3 x 100	Box of 50	800
STFHC5006125		6.3 x 125	Box of 50	600
STFHC5006140		6.3 x 140	Box of 50	600
STFHC5006150		6.3 x 150	Box of 50	600
STFHC5006190		6.3 x 190	Box of 50	400
STFHC5006200		6.3 x 200	Box of 50	400
STFHC5006240		6.3 x 240	Box of 50	400
STFHC5006250		6.3 x 250	Box of 50	400

SPARE HEX DRIVER BITS AVAILABLE TO PURCHASE SEPARATELY



Code	Size A/F (mm)	Pack Size	Outer Qty
STFBDB	8	Box of 10	-



## COACH SCREWS BZP

Ideal for heavy duty and structural applications. The hex head enables a high driving torque.

### CORE USE

- Hardwood
- Softwood
- Brick



For brick a nylon plug is needed.

### MATERIAL

- Bright zinc plated mild steel
- Manufactured to DIN 571

**THREAD**  
METRIC COARSE THREAD

**HEAD**  
HEX HEAD FOR USE WITH A SOCKET OR SPANNER



Code	Finish	Size	Length (mm)	Box Qty
SHSZ06025	BZP	M6	25	200
SHSZ06030		M6	30	200
SHSZ06040		M6	40	200
SHSZ06050		M6	50	200
SHSZ06060		M6	60	200
SHSZ06070		M6	70	200
SHSZ06075		M6	75	200
SHSZ06080		M6	80	200
SHSZ06090		M6	90	100
SHSZ06100		M6	100	100
SHSZ08030		M8	30	200
SHSZ08040		M8	40	200
SHSZ08050		M8	50	200
SHSZ08060		M8	60	100
SHSZ08065		M8	65	100
SHSZ08070		M8	70	100
SHSZ08075		M8	75	100
SHSZ08080		M8	80	100
SHSZ08090		M8	90	100
SHSZ08100		M8	100	100
SHSZ08120		M8	120	100
SHSZ08130		M8	130	50
SHSZ08140		M8	140	50
SHSZ08150		M8	150	50
SHSZ10040		M10	40	100
SHSZ10050		M10	50	100
SHSZ10060		M10	60	100
SHSZ10065		M10	65	100
SHSZ10070		M10	70	100
SHSZ10075		M10	75	100
SHSZ10080		M10	80	100
SHSZ10090		M10	90	100
SHSZ10100		M10	100	100
SHSZ10120		M10	120	50
SHSZ10130		M10	130	50
SHSZ10140		M10	140	50
SHSZ10150		M10	150	50
SHSZ10160		M10	160	50
SHSZ10180		M10	180	50
SHSZ10200		M10	200	50
SHSZ120500	M12	50	50	
SHSZ120600	M12	60	100	
SHSZ120700	M12	70	50	
SHSZ120750	M12	75	50	
SHSZ120800	M12	80	50	
SHSZ120900	M12	90	50	
SHSZ12100	M12	100	50	
SHSZ12120	M12	120	50	
SHSZ12140	M12	140	25	
SHSZ12150	M12	150	25	
SHSZ12160	M12	160	25	
SHSZ12180	M12	180	25	

## COACH SCREWS A2 STAINLESS STEEL

Ideal for heavy duty and structural applications. The hex head enables a high driving torque.

### CORE USE

- Hardwood
- Softwood
- Brick



For brick a nylon plug is needed.

### MATERIAL

- A2 Austenitic Stainless Steel for high corrosion resistance
- Manufactured to DIN 571

**THREAD**  
METRIC COARSE THREAD

**HEAD**  
HEX HEAD FOR USE WITH A SOCKET OR SPANNER



Code	Finish	Size	Length (mm)	Box Qty
SHST08040	A2 STAINLESS STEEL	M8	40	100
SHST08050		M8	50	100
SHST08060		M8	60	100
SHST08070		M8	70	100
SHST08100		M8	100	100
SHST08120		M8	120	100
SHST08150		M8	150	100
SHST10050		M10	50	100
SHST10060		M10	60	100
SHST10070		M10	70	100
SHST10080		M10	80	100
SHST10100		M10	100	100
SHST10120		M10	120	50
SHST10130		M10	130	100
SHST10150		M10	150	50
SHST10160		M10	160	50
SHST10180		M10	180	50
SHST10200		M10	200	50
SHST12050		M12	50	50
SHST12070		M12	70	50
SHST12080		M12	80	50
SHST12100		M12	100	50
SHST12120		M12	120	50
SHST12140		M12	140	50

## COACH SCREWS (DIN 571)

	M6	M8	M10	M12
<b>d</b>	6 mm (5.52-6.00)	8 mm (7.42-8.00)	10 mm (9.42-10.00)	12 mm (11.3-12.00)
<b>k</b>	4 mm (3.63-4.38)	5.5 mm (5.13-5.88)	7 mm (6.55-7.45)	8 mm (7.55-8.45)
<b>s</b>	10 mm (9.64-10.00)	13 mm (12.57-13.00)	17 mm (16.57-17.00)	19 mm (18.48-19.00)
<b>e</b>	min. 10.89 mm	min. 14.20 mm	min. 18.72 mm	min. 20.88 mm

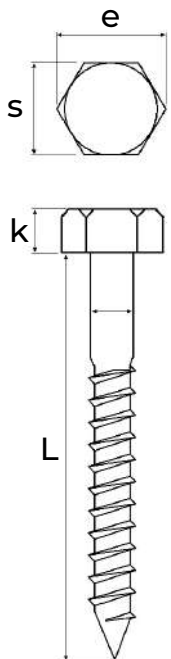

Bagged **Coach Screws** are available in our Bagged **Bolts** section.

## BRASS SLOTTED WOODSCREWS

Traditional screw used in a wide variety of applications including to fix ironmongery, in plumbing and as a decorative fixing. Self colour and chrome plated brass slotted screws.

### CORE USE

- Softwood
- Hardwood



Always drill a hole the same size of the screw prior to use.

### MATERIAL

- Solid brass is anti-corrosive, water resistant and the brass colour works well with wood



### SELF COLOUR BRASS

### CHROME PLATED BRASS

Gauge	Length	Box Qty	Countersunk SCBS	Round Head SRBS	Raised Head SABS	Gauge	Length	Box Qty	Countersunk SCBC	Round Head SRBC	Raised Head SABC
2	3/8"	200	✓			2	3/8"	200			
2	1/2"	200	✓	✓		2	1/2"	200			
3	3/8"	200	✓	✓		3	3/8"	200			
3	1/2"	200	✓	✓		3	1/2"	200			
4	3/8"	200	✓			4	3/8"	200			
4	1/2"	200	✓	✓	✓	4	1/2"	200	✓	✓	✓
4	5/8"	200	✓	✓	✓	4	5/8"	200		✓	✓
4	3/4"	200	✓	✓	✓	4	3/4"	200	✓	✓	✓
4	1"	200	✓	✓	✓	4	1"	200		✓	✓
5	1/2"	200	✓			5	1/2"	200			
5	3/8"	200	✓			5	3/8"	200			
5	3/4"	200	✓		✓	5	3/4"	200			✓
5	1"	200	✓			5	1"	200			
6	1/2"	200	✓	✓	✓	6	1/2"	200	✓	✓	✓
6	5/8"	200	✓	✓	✓	6	5/8"	200	✓	✓	✓
6	3/4"	200	✓	✓	✓	6	3/4"	200	✓	✓	✓
6	1"	200	✓	✓	✓	6	1"	200	✓	✓	✓
6	1 1/4"	200	✓	✓	✓	6	1 1/4"	200	✓	✓	
6	1 1/2"	200	✓	✓	✓	6	1 1/2"	200		✓	✓
7	3/4"	200	✓		✓	7	3/4"	200			
7	1"	200	✓		✓	7	1"	200			
7	1 1/4"	200	✓			7	1 1/4"	200			
7	1 1/2"	200	✓			7	1 1/2"	200			
8	1/2"	200	✓	✓		8	1/2"	200			
8	5/8"	200	✓			8	5/8"	200			
8	3/4"	200	✓	✓	✓	8	3/4"	200	✓	✓	✓
8	1"	200	✓	✓	✓	8	1"	200	✓	✓	✓
8	1 1/4"	200	✓	✓	✓	8	1 1/4"	200	✓	✓	✓
8	1 1/2"	200	✓	✓	✓	8	1 1/2"	200	✓	✓	✓
8	1 3/4"	200	✓	✓		8	1 3/4"	200			
8	2"	200	✓	✓		8	2"	200		✓	
8	2 1/2"	100	✓			8	2 1/2"	100			
8	3"	100	✓			8	3"	100			
10	3/4"	200	✓			10	3/4"	200			
10	1"	200	✓	✓	✓	10	1"	200			
10	1 1/4"	200	✓	✓	✓	10	1 1/4"	200	✓	✓	✓
10	1 1/2"	200	✓	✓	✓	10	1 1/2"	200	✓	✓	✓
10	1 3/4"	200	✓			10	1 3/4"	200			
10	2"	200	✓	✓		10	2"	200		✓	
10	2 1/2"	200	✓			10	2 1/2"	200			
10	3"	100	✓			10	3"	100			
12	1 1/4"	200	✓			12	1 1/4"	200			
12	1 1/2"	200	✓			12	1 1/2"	200			
12	2"	200	✓	✓		12	2"	200			
12	2 1/2"	200	✓			12	2 1/2"	200			
12	3"	100	✓			12	3"	100			
12	4"	100	✓			12	4"	100			
14	4"	50	✓			14	4"	50			



### SELF TAPPING SCREWS WITH A SHARP POINT

USED FOR A LARGE VARIETY OF MATERIALS INCLUDING THIN SHEET METAL AND PLASTICS

**A PRE-DRILLED PILOT HOLE IS REQUIRED (ESPECIALLY WHEN WORKING WITH METAL)**

IDEAL WHEN WORKING WITH PRODUCTS THAT NEED TO BE MAINTAINED REGULARLY - WHEN YOU NEED TO DISMANTLE AND REASSEMBLE THE ITEM ALONG THE SAME THREADS



## RECESSED SELF TAPPING SCREWS

### CORE USE

- Thin Sheet Metal
- Plastics
- Softwood

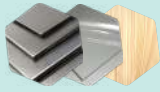

**SMALL PILOT HOLE RECOMMENDED**

### MATERIAL

- Bright Zinc Plated (BZP) case hardened steel (CR-3)

**ALSO AVAILABLE PREPACKED**  
SEE OUR CLAMPAQ SCREWS SECTION

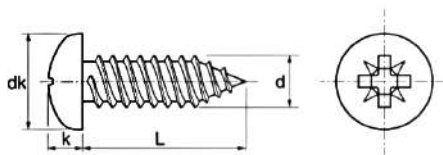

### HEAD

POZI RECESSED PAN HEAD WITH A ROUNDED BASE, LARGE DIAMETER & HIGH EDGES FOR INCREASED TORQUE AND LOW RISK OF SCREW DAMAGE

### THREAD

FULLY THREADED

### POINT

TYPE AB POINT HAS MORE THREADS PER INCH AND MORE EFFECTIVE IN BRITTLE MATERIALS

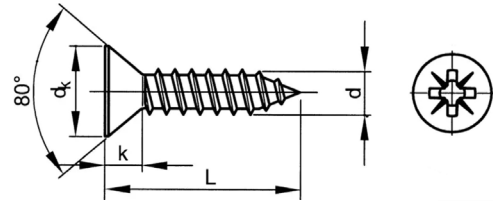

### HEAD

POZI RECESSED COUNTERSUNK FOR A SMOOTH, FLUSH FINISH

### THREAD

FULLY THREADED

### POINT

TYPE AB POINT HAS MORE THREADS PER INCH AND MORE EFFECTIVE IN BRITTLE MATERIALS



### PAN HEAD

### COUNTERSUNK

Code	Finish	Gauge	Length	Box Qty	Code	Finish	Gauge	Length	Box Qty	
STPR040375	BZP	4	3/8"	200	STRZ040375	BZP	4	3/8"	200	
STPR04050		4	1/2"	200	STRZ040500		4	1/2"	200	
STPR040625		4	5/8"	200	STRZ040625		4	5/8"	200	
STPR04075		4	3/4"	200	STRZ06050		6	1/2"	200	
STPR060375		6	3/8"	200	STRZ060625		6	5/8"	200	
STPR06050		6	1/2"	200	STRZ06075		6	3/4"	200	
STPR060625		6	5/8"	200	STRZ06100		6	1"	200	
STPR06075		6	3/4"	200	STRZ08050		8	1/2"	200	
STPR06100		6	1"	200	STRZ08075		8	3/4"	200	
STPR06125		6	1 1/4"	200	STRZ08100		8	1"	200	
STPR080375		8	3/8"	200	STRZ08125		8	1 1/4"	200	
STPR08050		8	1/2"	200	STRZ08150		8	1 1/2"	200	
STPR080625		8	5/8"	200	STRZ10075		10	3/4"	200	
STPR08075		8	3/4"	200	STRZ10100		10	1"	200	
STPR08100		8	1"	200	STRZ10125		10	1 1/4"	200	
STPR08125		8	1 1/4"	200	STRZ10150		10	1 1/2"	200	
STPR08150		8	1 1/2"	200	STRZ10200		10	2"	200	
STPR10050		10	1/2"	200						
STPR10075		10	3/4"	200						
STPR10100		10	1"	200						
STPR10150		10	1 1/2"	200						
STPR12150		12	1 1/2"	200						

Our **Self Tappers** do not have a self drilling point.

**OUR RECOMMENDATION** if you don't want to drill a pilot hole, is to use a self drilling fixing instead of a self tapper. See our Fixings section for self drilling fixings.

## MIRROR SCREWS

### CORE USE

- Used to give a concealed, decorative and water resistant finish

### MATERIAL

- BZP screw & a chrome plated brass dome top



Code	Finish	Gauge	Length	Box Qty
SRMC080750	CHROME PLATED	8	3/4"	100
SRMC081		8	1"	100
SRMC08125		8	1 1/4"	100
SRMC0815		8	1 1/2"	100
SRMC082		8	2"	100

## CARCASS SCREWS

### CORE USE

- Softwood
- Coated Chipboard



Designed for constructing or fixing the framework of furniture.

### DURABILITY

- Black Phosphate for indoor use

HEAD RECESSED COUNTERSUNK

THREAD SINGLE COARSE



Code	Finish	Gauge (mm)	Length (mm)	Box Qty
SCCZ07033	BLACK PHOSPHATE	4	33	1000
SCCZ07045		4	45	1000

## ANTI-VANDAL SECURITY SCREWS

### CORE USE

- One way pozi drive twinthread security system

### MATERIAL

- Bright Zinc Plated (BZP) case hardened steel (CR-3)

HEAD ONE WAY RECESSED, SO THE SCREW CANNOT BE REMOVED ONCE IN PLACE



Code	Finish	Gauge	Length	Box Qty
SLSZ080750	BZP	8	3/4"	200
SLSZ081000		8	1"	200
SLSZ081250		8	1 1/4"	200
SLSZ101250		10	1 1/4"	200
SLSZ101500		10	1 1/2"	200
SLSZ122000		12	2"	200

## SURFACE PATTERN SCREW CUPS

SOLID BRASS

- Avoids the need to countersink the screw head into the wood
- Can be used to produce a decorative finish



SELF COLOUR BRASS

NICKEL PLATED BRASS

Code	To Suit Gauge (g)	Box Qty	Code	To Suit Gauge (g)	Box Qty
SSSB045	4-5	200	SSSN045	4-5	200
SSSB06	6	200	SSSN06	6	200
SSSB078	7-8	200	SSSN078	7-8	200
SSSB0910	9-10	200	SSSN0910	9-10	200
SSSB12	12	200	SSSN1210	12	200
SSSB14	14	200	SSSN14	14	200

## TONGUE-TITE SCREWS

### CORE USE

- Hidden removable fixing for all tongue and groove flooring, including hardwood, softwood and fireboards

### MATERIAL

- Zinc & Yellow Passivated for indoor use

HEAD SELF-COUNTERSINKING LOST HEAD FOR A SMOOTH CONCEALED FINISH

THREAD TRI-LOCK TS THREAD WILL NOT SPLIT TIMBER



FREE T10 DRIVER BITS IN EACH BOX

200 screws will fix up to 10m<sup>2</sup>.

Code	Finish	Size (mm)	Box Qty
STTZ35045	ZINC & YELLOW	3.5 x 45	200

## RECESSED PATTERN SCREW CUPS

SOLID BRASS

- Also known as "turned pattern brass screw cups"
- Solid brass knurled screw cups, fully recess into the wood
- Used to finish brass countersunk head screws



Code	Finish	To Suit Gauge (g)	Box Qty
SSRB006	SELF COLOUR BRASS	6	200
SSRB008		8	200
SSRB010		10	200
SSRB012		12	200

Our **Solid Brass Screw Cups** are anti-corrosive, water resistant and the brass colour works well with wood.

### COVERS FOR RECESS HEAD SCREWS

#### CORE USE

- A decorative plastic cover for pozi or cross recess head countersunk woodscrews



DIFFERENT COLOURS AVAILABLE FOR DIFFERENT WOOD MATERIALS

Code	Finish	Size	Box Qty
SPCT002	Light Brown	No. 2	1000
SPCB002	Black	No. 2	1000
SPCW002	White	No. 2	1000

### DOMES TOPS

#### CORE USE

- For use with all types of woodscrews
- Two piece construction helps with a speedy implementation and leaves the cap difficult to remove



Code	Finish	To Suit Gauge (g)	Box Qty
SPDB001	Black	6 - 8	100
SPDBLB001	Light Brown	6 - 8	100
SPDW001	White	6 - 8	100
SPDC001	Chrome Plated	6 - 8	100
SPDR001	Brown	6 - 8	100

ALSO AVAILABLE PREPACKED IN OUR CLAMPAQ SCREWS SECTION



Over 250m screws sold per year...

### PLASTIC WALL PLUGS

#### CORE USE

- Used in conjunction with woodscrews to fix into concrete, brick or masonry (solid walls only)
- Fixed into a pilot hole before the screw is screwed in

INDUSTRY STANDARD SIZING COLOUR CODED RECYCLABLE



PACKED IN BOXES OF 1000 NO WRAPPED INTO OUTERS OF 1000 OR 100

Code	Colour	To Suit Gauge (g)	To Suit Gauge (mm)	Drill Size (mm)	Outer Qty
SPPY001	Yellow	4-8	3.0-4.0	5	1000
SPPR001	Red	6-10	3.5-5.0	5.5	1000
SPPB001	Brown	8-12	4.0-5.5	7	1000
SPPE001	Blue	12-14	5.5-6.3	10	100

### PLASTIC WALL PLUGS INSTALLATION



Before you start, **consider the weight** of the object you wish to hang and this will determine the **screw gauge** you'll need.

- 1 Insert correct bit into the drill
- 2 Drill a pilot hole straight into the wall just long enough to accommodate the screw
- 3 Push the plug into the hole and then use a hammer to get it flush - the plug must fit
- 4 Hold the object you are fixing in place and gently twist in the screw
- 5 Tighten the screw in place for a secure hold



## PREPACKED SCREWS & SCREW ACCESSORIES IN HANGING CLAMS

JOHN GEORGE BRANDED  
 PROVIDED IN CLEAR EUROSLOTTED CLAMS  
 AVAILABLE OFF THE SHELF  
 IDEAL FOR SMALL JOBS & DIY  
 SOLD IN OUTERS  
 INCLUDES OUR SUPER DRIVE, TWINTHREAD &  
 UNIVERSAL SCREWS!

### SUPER DRIVE PROFESSIONAL WOODSCREWS

	Finish	Head Type	Size	
				Outer Qty 10 CLAMPAQ Qty
S6PD030012	ZINC & YELLOW	Countersunk	3.0 x 12	25no
S6PD030020		Countersunk	3.0 x 20	25no
S6PD030025		Countersunk	3.0 x 25	25no
S6PD035012		Countersunk	3.5 x 12	25no
S6PD035016		Countersunk	3.5 x 16	25no
S6PD035020		Countersunk	3.5 x 20	25no
S6PD035025		Countersunk	3.5 x 25	20no
S6PD035030		Countersunk	3.5 x 30	20no
S6PD040020		Countersunk	4.0 x 20	20no
S6PD040025		Countersunk	4.0 x 25	20no
S6PD040030		Countersunk	4.0 x 30	15no
S6PD040040		Countersunk	4.0 x 40	15no
S6PD040045		Countersunk	4.0 x 45	15no
S6PD040050		Countersunk	4.0 x 50	15no
S6PD040060		Countersunk	4.0 x 60	10no
S6PD040070		Countersunk	4.0 x 70	10no
S6PD050030		Countersunk	5.0 x 30	15no
S6PD050040		Countersunk	5.0 x 40	10no
S6PD050050		Countersunk	4.0 x 50	8no
S6PD050060		Countersunk	5.0 x 60	8no
S6PD050070		Countersunk	5.0 x 70	5no
S6PD050080		Countersunk	5.0 x 80	5no
S6PD050090		Countersunk	5.0 x 90	5no
S6PD050100		Countersunk	5.0 x 100	5no
S6PD060050		Countersunk	6.0 x 50	5no
S6PD060060		Countersunk	6.0 x 60	5no
S6PD060070		Countersunk	6.0 x 70	4no
S6PD060080		Countersunk	6.0 x 80	4no
S6PD060090		Countersunk	6.0 x 90	4no
S6PD060100		Countersunk	6.0 x 100	4no

### TWINTHREAD WOODSCREWS COUNTERSUNK

	Finish	Head Type	Size	
				Outer Qty 10 CLAMPAQ Qty
S6FHZ0405	BZP	Countersunk	4 x 1/2"	45no
S6FHZ040625		Countersunk	4 x 5/8"	35no
S6FHZ04075		Countersunk	4 x 3/4"	35no
S6FHZ06050		Countersunk	6 x 1/2"	40no
S6FHZ060625		Countersunk	6 x 5/8"	35no
S6FHZ06075		Countersunk	6 x 3/4"	35no
S6FHZ061		Countersunk	6 x 1"	30no
S6FHZ06125		Countersunk	6 x 1 1/4"	25no
S6FHZ0615		Countersunk	6 x 1 1/2"	20no
S6FHZ062		Countersunk	6 x 2"	20no
S6FHZ071		Countersunk	7 x 1"	25no
S6FHZ07125		Countersunk	7 x 1 1/4"	20no
S6FHZ08075		Countersunk	8 x 3/4"	30no
S6FHZ081		Countersunk	8 x 1"	25no
S6FHZ08125		Countersunk	8 x 1 1/4"	20no
S6FHZ0815		Countersunk	8 x 1 1/2"	18no
S6FHZ08175		Countersunk	8 x 1 3/4"	15no
S6FHZ082		Countersunk	8 x 2"	10no
S6FHZ0825		Countersunk	8 x 2 1/2"	6no
S6FHZ083		Countersunk	8 x 3"	6no
S6FHZ101		Countersunk	10 x 1"	15no
S6FHZ10125		Countersunk	10 x 1 1/4"	10no
S6FHZ1015		Countersunk	10 x 1 1/2"	10no
S6FHZ10175		Countersunk	10 x 1 3/4"	10no
S6FHZ102		Countersunk	10 x 2"	8no
S6FHZ1025		Countersunk	10 x 2 1/2"	6no
S6FHZ103		Countersunk	10 x 3"	4no
S6FHZ1035		Countersunk	10 x 3 1/2"	4no
S6FHZ104		Countersunk	10 x 4"	4no
S6FHZ1215		Countersunk	12 x 1 1/2"	8no
S6FHZ122		Countersunk	12 x 2"	6no
S6FHZ1225		Countersunk	12 x 2 1/2"	6no
S6FHZ123	Countersunk	12 x 3"	4no	
S6FHZ124	Countersunk	12 x 4"	4no	







## TWINTHREAD WOODSCREWS ROUND HEAD

	Finish	Head Type	Size	CLAMPAQ Qty		
				Outer Qty	10	
				CLAMPAQ	Qty	
S6RSZ06075	BZP	Round Head	6 x 3/4"	40no		
S6RSZ061		Round Head	6 x 1"	35no		
S6RSZ08075		Round Head	8 x 3/4"	25no		
S6RSZ081		Round Head	8 x 1"	25no		
S6RSZ08125		Round Head	8 x 1 1/4"	20no		
S6RSZ0815		Round Head	8 x 1 1/2"	20no		
S6RSZ082		Round Head	8 x 2"	15no		
S6RSZ101		Round Head	10 x 1"	25no		
S6RSZ10125		Round Head	10 x 1 1/4"	15no		
S6RSZ1015		Round Head	10 x 1 1/2"	15no		
S6RSB06075		BLACK ORGANIC	Round Head	6 x 3/4"	40no	
S6RSB061			Round Head	6 x 1"	35no	
S6RSB08075	Round Head		8 x 3/4"	25no		
S6RSB081	Round Head		8 x 1"	25no		
S6RSB08125	Round Head		8 x 1 1/4"	20no		
S6RSB0815	Round Head		8 x 1 1/2"	20no		
S6RSB082	Round Head		8 x 2"	15no		
S6RSB101	Round Head		10 x 1"	20no		
S6RSB10125	Round Head		10 x 1 1/4"	15no		
S6RSB1015	Round Head		10 x 1 1/2"	15no		
S6RSB102	Round Head		10 x 2"	10no		

## UNIVERSAL WOODSCREWS

	Finish	Head Type	Size	CLAMPAQ Qty	
				Outer Qty	10
				CLAMPAQ	Qty
S6IHZ030013	ZINC & YELLOW	Countersunk	3.0 x 13	30no	
S6IHZ030016		Countersunk	3.0 x 16	30no	
S6IHZ030020		Countersunk	3.0 x 20	30no	
S6IHZ035013		Countersunk	3.5 x 13	30no	
S6IHZ035016		Countersunk	3.5 x 16	30no	
S6IHZ035020		Countersunk	3.5 x 20	30no	
S6IHZ035025		Countersunk	3.5 x 25	25no	
S6IHZ035030		Countersunk	3.5 x 30	25no	
S6IHZ035040		Countersunk	3.5 x 40	20no	
S6IHZ040020		Countersunk	4.0 x 20	25no	
S6IHZ040025		Countersunk	4.0 x 25	25no	
S6IHZ040030		Countersunk	4.0 x 30	20no	
S6IHZ040040		Countersunk	4.0 x 40	20no	
S6IHZ040045		Countersunk	4.0 x 45	20no	
S6IHZ040050		Countersunk	4.0 x 50	20no	
S6IHZ040060		Countersunk	4.0 x 60	15no	
S6IHZ045030		Countersunk	4.5 x 30	20no	
S6IHZ045040		Countersunk	4.5 x 40	10no	
S6IHZ045050		Countersunk	4.5 x 50	10no	
S6IHZ050030		Countersunk	5.0 x 30	20no	
S6IHZ050040		Countersunk	5.0 x 40	15no	
S6IHZ050045		Countersunk	5.0 x 45	15no	
S6IHZ050050		Countersunk	5.0 x 50	12no	
S6IHZ050060		Countersunk	5.0 x 60	10no	
S6IHZ050070		Countersunk	5.0 x 70	8no	
S6IHZ050080		Countersunk	5.0 x 80	8no	
S6IHZ050100		Countersunk	5.0 x 100	8no	
S6IHZ060050		Countersunk	6.0 x 50	8no	
S6IHZ060060		Countersunk	6.0 x 60	5no	
S6IHZ060070		Countersunk	6.0 x 70	5no	
S6IHZ060080	Countersunk	6.0 x 80	5no		
S6IHZ060100	Countersunk	6.0 x 100	5no		
S6CTR35020	A2 STAINLESS STEEL	Countersunk	3.5 x 20	30no	
S6CTR35025		Countersunk	3.5 x 25	30no	
S6CTR40020		Countersunk	4.0 x 20	25no	
S6CTR40025		Countersunk	4.0 x 25	25no	
S6CTR40030		Countersunk	4.0 x 30	25no	
S6CTR40040		Countersunk	4.0 x 40	20no	
S6CTR40050		Countersunk	4.0 x 50	15no	
S6CTR50025		Countersunk	5.0 x 25	20no	
S6CTR50030		Countersunk	5.0 x 30	20no	
S6CTR50040		Countersunk	5.0 x 40	15no	
S6CTR50050		Countersunk	5.0 x 50	10no	
S6CTR50060		Countersunk	5.0 x 60	10no	
S6CTR50070		Countersunk	5.0 x 70	8no	
S6CTR50100		Countersunk	5.0 x 100	5no	
S6CTR60050		Countersunk	6.0 x 50	8no	
S6CTR60060		Countersunk	6.0 x 60	5no	
S6CTR60070		Countersunk	6.0 x 70	5no	
S6CTR60100		Countersunk	6.0 x 100	4no	

## RECESSED SELF TAPPING SCREWS

	Finish	Head Type	Size	CLAMPAQ Qty	
				Outer Qty	10
				CLAMPAQ	Qty
S6TPR040375	BZP	Pan Head	4 x 3/8"	30no	
S6TPR0405		Pan Head	4 x 1/2"	30no	
S6TPR060375		Pan Head	6 x 3/8"	30no	
S6TPR0605		Pan Head	6 x 1/2"	30no	
S6TPR060625		Pan Head	6 x 5/8"	25no	
S6TPR06075		Pan Head	6 x 3/4"	25no	
S6TPR061		Pan Head	6 x 1"	25no	
S6TPR06125		Pan Head	6 x 1 1/4"	20no	
S6TPR080375		Pan Head	8 x 3/8"	25no	
S6TPR0805		Pan Head	8 x 1/2"	25no	
S6TPR080625		Pan Head	8 x 5/8"	25no	
S6TPR08075		Pan Head	8 x 3/4"	25no	
S6TPR081		Pan Head	8 x 1"	20no	
S6TPR08125		Pan Head	8 x 1 1/4"	15no	
S6TPR0815		Pan Head	8 x 1 1/2"	15no	
S6TPR1005		Pan Head	10 x 1/2"	20no	
S6TPR10075		Pan Head	10 x 3/4"	15no	
S6TPR101		Pan Head	10 x 1"	12no	
S6TPR1015		Pan Head	10 x 1 1/2"	8no	

## BRASS SLOTTED WOODSCREWS COUNTERSUNK

	Finish	Head Type	Size	Outer Qty 10
				CLAMPAQ Qty
S6CBS020375	SELF COLOUR BRASS	Countersunk	2 x 3/8"	50no
S6CBS0205		Countersunk	2 x 1/2"	50no
S6CBS040375		Countersunk	4 x 3/8"	50no
S6CBS0405		Countersunk	4 x 1/2"	50no
S6CBS040625		Countersunk	4 x 5/8"	40no
S6CBS04075		Countersunk	4 x 3/4"	40no
S6CBS041		Countersunk	4 x 1"	40no
S6CBS06050		Countersunk	6 x 1/2"	45no
S6CBS060675		Countersunk	6 x 3/8"	40no
S6CBS06075		Countersunk	6 x 3/4"	40no
S6CBS061		Countersunk	6 x 1"	35no
S6CBS06125		Countersunk	6 x 1 1/4"	30no
S6CBS0615		Countersunk	6 x 1 1/2"	20no
S6CBS071		Countersunk	7 x 1"	35no
S6CBS07125		Countersunk	7 x 1 1/4"	25no
S6CBS0805		Countersunk	8 x 1/2"	30no
S6CBS08075		Countersunk	8 x 3/4"	30no
S6CBS081		Countersunk	8 x 1"	30no
S6CBS08125		Countersunk	8 x 1 1/4"	25no
S6CBS0815		Countersunk	8 x 1 1/2"	20no
S6CBS082		Countersunk	8 x 2"	15no
S6CBS10125		Countersunk	10 x 1 1/4"	15no
S6CBS1015		Countersunk	10 x 1 1/2"	15no
S6CBS10175		Countersunk	10 x 1 3/4"	10no
S6CBS102		Countersunk	10 x 2"	10no
S6CBS1025		Countersunk	10 x 2 1/2"	10no
S6CBS103		Countersunk	10 x 3"	4no
S6CBS122		Countersunk	12 x 2"	6no
S6CBS1225		Countersunk	12 x 2 1/2"	4no
S6CBS123		Countersunk	12 x 3"	4no

## BRASS SLOTTED WOODSCREWS ROUND HEAD

	Finish	Head Type	Size (inch)	Outer Qty 10
				CLAMPAQ Qty
S6RBS0405	SELF COLOUR BRASS	Round Head	4 x 1/2"	50no
S6RBS04075		Round Head	4 x 3/4"	30no
S6RBS0605		Round Head	6 x 1/2"	30no
S6RBS06075		Round Head	6 x 3/4"	30no
S6RBS061		Round Head	6 x 1"	25no
S6RBS06125		Round Head	6 x 1 1/2"	25no
S6RBS08075		Round Head	8 x 3/4"	20no
S6RBS081		Round Head	8 x 1"	20no
S6RBS08125		Round Head	8 x 1 1/4"	20no
S6RBS0815		Round Head	8 x 1 1/2"	20no
S6RBS1015		Round Head	10 x 1 1/2"	15no



## BRASS SLOTTED WOODSCREWS RAISED HEAD

	Finish	Head Type	Size	Outer Qty 10
				CLAMPAQ Qty
S6ABC0405	CHROME PLATED BRASS	Raised Head	4 x 1/2"	20no
S6ABC04075		Raised Head	4 x 3/4"	10no
S6ABC06075		Raised Head	6 x 3/4"	10no
S6ABC061		Raised Head	6 x 1"	10no
S6ABC08075		Raised Head	8 x 3/4"	10no
S6ABC081		Raised Head	8 x 1"	10no

## SCREW CUPS, COVERS & DOME TOPS

Type	Code	Finish	Size	Outer Qty 10	
				CLAMPAQ Qty	
SURFACE SCREW CUPS	S6SS		SELF COLOUR BRASS	No. 6	30no
				No. 7/8	30no
				No. 9/10	30no
SCREW COVERS	S6PC		NICKEL PLATED BRASS	No. 6	30no
				No. 7/8	30no
				No. 9/10	30no
DOME TOPS	S6PD		BLACK	-	10no
			CHROME	-	4no
			BROWN	-	10no
			WHITE	-	10no

## SPECIALIST SCREWS

Type	Code	Finish	Size	Outer Qty 10	
				CLAMPAQ Qty	
MIRROR SCREWS	S6RMC		CHROME PLATED	8 x 1"	4no
				8 x 1 1/4"	4no
				8 x 1 1/2"	4no
ANTI- VANDAL SECURITY SCREWS	S6LSZ		BZP	8 x 3/4"	10no
				8 x 1"	8no
				8 x 1 1/4"	8no
				10 x 1 1/2"	6no

ClamPAQ Machine Screws are available in our Bolts section.

## CUP SQUARE HEX CARRIAGE BOLTS

Code	Finish	Size (mm)	Box Qty	Outer Qty
BCSZ06025	BZP	M6 x 25	200	1600
BCSZ06040		M6 x 40	200	1200
BCSZ06050		M6 x 50	200	1200
BCSZ06065		M6 x 65	100	800
BCSZ06070		M6 x 70	100	800
BCSZ06075		M6 x 75	100	800
BCSZ06080		M6 x 80	100	800
BCSZ06090		M6 x 90	100	600
BCSZ06100		M6 x 100	100	600
BCSZ06110		M6 x 110	100	600
BCSZ06130		M6 x 130	100	400
BCSZ06150		M6 x 150	100	400
BCSZ08025		M8 x 25	200	800
BCSZ08030		M8 x 30	200	800
BCSZ08040		M8 x 40	200	800
BCSZ08050		M8 x 50	100	600
BCSZ08060		M8 x 60	100	400
BCSZ08065		M8 x 65	100	400
BCSZ08070		M8 x 70	100	400
BCSZ08075		M8 x 75	100	400
BCSZ08080		M8 x 80	100	400
BCSZ08090		M8 x 90	50	300
BCSZ08100		M8 x 100	50	300
BCSZ08110		M8 x 110	50	300
BCSZ08120		M8 x 120	50	300
BCSZ08130		M8 x 130	50	300
BCSZ08140		M8 x 140	50	300
BCSZ08150		M8 x 150	50	300
BCSZ08160		M8 x 160	50	300
BCSZ08180		M8 x 180	50	150
BCSZ08200		M8 x 200	50	150
BCSZ10050		M10 x 50	100	300
BCSZ10065		M10 x 65	50	200
BCSZ10070		M10 x 70	50	200
BCSZ10075		M10 x 75	50	200
BCSZ10080		M10 x 80	50	200
BCSZ10090		M10 x 90	50	200
BCSZ10100		M10 x 100	50	200
BCSZ10110		M10 x 110	50	200
BCSZ10120		M10 x 120	50	200
BCSZ10130		M10 x 130	50	200
BCSZ10140		M10 x 140	50	200
BCSZ10150		M10 x 150	50	200
BCSZ10160		M10 x 160	50	150
BCSZ10180		M10 x 180	50	150
BCSZ10200		M10 x 200	50	150
BCSZ10220		M10 x 220	50	100
BCSZ10230		M10 x 230	50	100
BCSZ10240		M10 x 240	50	100
BCSZ10260		M10 x 260	40	80
BCSZ10300		M10 x 300	25	50
BCSZ12050		M12 x 50	50	150
BCSZ12065		M12 x 65	50	150
BCSZ12075		M12 x 75	50	150
BCSZ12080		M12 x 80	25	100
BCSZ12090		M12 x 90	25	100
BCSZ12100		M12 x 100	25	100
BCSZ12110		M12 x 110	25	100
BCSZ12130		M12 x 130	25	100
BCSZ12150		M12 x 150	25	100
BCSZ12160		M12 x 160	25	100
BCSZ12180		M12 x 180	25	75
BCSZ12200		M12 x 200	25	75
BCSZ12220		M12 x 220	25	75
BCSZ12240		M12 x 240	25	75
BCSZ12260		M12 x 260	25	75
BCSZ12280		M12 x 280	25	75
BCSZ12300		M12 x 300	25	75
BCSZ16100		M16 x 100	10	40
BCSZ16110		M16 x 110	10	40
BCSZ16130		M16 x 130	10	40
BCSZ16150		M16 x 150	10	40
BCSZ16180		M16 x 180	10	30
BCSZ16200		M16 x 200	10	30

### CORE USE

- Used in carpentry and timber construction for wood to wood joints

### MATERIAL

- Bolts for structural timber applications according to EN 10083-2
- BZP conforms to DIN 603, Grade 4.8 and CE marked
- Available finishes:
  - Bright Zinc Plated (BZP):** Service Class 1 (includes nuts DIN 555) According to EN 14592: 2008 + A1: 2012
  - A2 stainless steel:** Ultimate corrosion resistance (excludes nuts) - not CE marked

**UK CA**  
**HEAD**  
 DOMED WITH A SQUARE UNDERSIDE - THIS LOCKS THE TIMBER AND HELPS KEEP THE BOLT FROM SPINNING

**THREAD**  
 METRIC COARSE THREAD FULLY THREADED UP TO AT LEAST 100MM



### CUP SQUARE BOLTS (DIN 603)

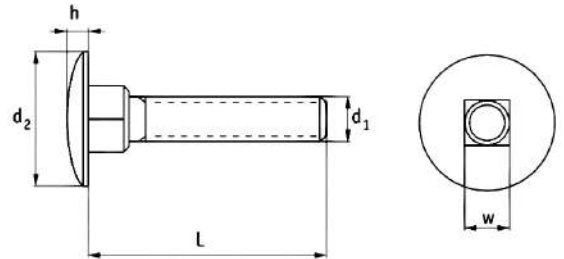

d <sub>1</sub> (mm)	M6	M8	M10	M12	M16
d <sub>2</sub> (mm)	max. 16.55	max. 20.65	max. 24.65	max. 30.65	max. 38.80
h (mm)	max. 3.88	max. 4.88	max. 5.38	max. 6.95	max. 8.95
w (mm)	max. 6.48	max. 8.58	max. 10.58	max. 12.70	max. 16.70
L < 125 (mm)	18	22	26	30	38
125 < L < 200 (mm)	24	28	32	36	44
L > 200 (mm)	-	41	45	49	57

### STAINLESS STEEL NOT PROVIDED WITH NUTS

Code	Material	Size	Box Qty	Outer Qty
BCST08050	A2 STAINLESS STEEL	M8 x 50	100	-
BCST08065		M8 x 65	100	-
BCST08080		M8 x 80	100	-
BCST08100		M8 x 100	100	-
BCST08110		M8 x 110	100	-
BCST08130		M8 x 130	100	-
BCST08150		M8 x 150	100	-
BCST10050		M10 x 50	50	-
BCST10065		M10 x 65	50	-
BCST10080		M10 x 80	50	-
BCST10100		M10 x 100	50	-
BCST10110		M10 x 110	50	-
BCST10130		M10 x 130	50	-
BCST10150		M10 x 150	50	-
BCST10180		M10 x 180	50	-
BCST10200		M10 x 200	50	-
BCST12080		M12 x 80	50	-
BCST12100		M12 x 100	25	-
BCST12110		M12 x 110	25	-
BCST12130		M12 x 130	50	-
BCST12150	M12 x 150	50	-	

## HEX SET SCREWS

### CORE USE

- Often used for automotive fixing and other application where high strength is needed
- Ideal for metal to metal clamping applications

### MATERIAL

- Bright Zinc Plated (BZP) high tensile steel Grade 8.8
- A2 Stainless Steel for ultimate corrosion resistance
- Both conform to DIN 933, standard thread length

**THREAD**  
FULLY THREADED METRIC  
COARSE THREAD



Code	Finish	Size (mm)	Head Size A/F (mm)	Box Qty	
BXSZ06020	BZP (HT Steel)	M6 x 20	10	200	
BXSZ06025		M6 x 25	10	200	
BXSZ06040		M6 x 40	10	200	
BXSZ06050		M6 x 50	10	200	
BXSZ06100		M6 x 100	10	200	
BXSZ08020		M8 x 20	13	200	
BXSZ08025		M8 x 25	13	200	
BXSZ08030		M8 x 30	13	200	
BXSZ08040		M8 x 40	13	200	
BXSZ08050		M8 x 50	13	200	
BXSZ08060		M8 x 60	13	100	
BXSZ08080		M8 x 80	13	100	
BXSZ08100		M8 x 100	13	100	
BXSZ10020		M10 x 20	17	200	
BXSZ10025		M10 x 25	17	200	
BXSZ10040		M10 x 40	17	100	
BXSZ10050		M10 x 50	17	100	
BXSZ10070		M10 x 70	17	100	
BXSZ10080		M10 x 80	17	50	
BXSZ10100		M10 x 100	17	50	
BXSZ12025		M12 x 25	19	100	
BXSZ12040		M12 x 40	19	100	
BXSZ12050		M12 x 50	19	100	
BXSZ12060		M12 x 60	19	100	
BXSZ12070		M12 x 70	19	50	
BXSZ12080		M12 x 80	19	50	
BXSZ12100		M12 x 100	19	50	
BXSZ16040		M16 x 40	24	25	
BXSZ16050		M16 x 50	24	25	
BXSZ16060		M16 x 60	24	25	
BXSZ16080		M16 x 80	24	25	
BXSZ16100		M16 x 100	24	25	
BXSZ20040		M20 x 40	30	25	
BXSZ20050		M20 x 50	30	25	
BXSZ20060		M20 x 60	30	25	
BXSZ20080		M20 x 80	30	25	
BXSZ20100		M20 x 100	30	25	
BXST06025		A2 STAINLESS STEEL	M6 x 25	10	200
BXST06050			M6 x 50	10	100
BXST08025			M8 x 25	13	100
BXST08050	M8 x 50		13	100	
BXST08080	M8 x 80		13	50	
BXST08100	M8 x 100		13	50	
BXST10025	M10 x 25		17	100	
BXST10050	M10 x 50		17	50	
BXST10080	M10 x 80		17	50	
BXST10100	M10 x 100		17	50	
BXST12025	M12 x 25		19	100	
BXST12050	M12 x 50		19	50	
BXST12080	M12 x 80	19	50		
BXST12100	M12 x 100	19	50		

## HEX ROUND BOLTS HIGH TENSILE

### CORE USE

- Widely used in construction in the structural fixing of steel

### MATERIAL

- High strength bolts made from high tensile steel Grade 8.8
- Conforms to DIN 931, standard thread length
- Bright Zinc Plated (BZP) Service Class 1

**THREAD**  
METRIC COARSE THREAD  
WITH ROUND SHANK  
PARTIALLY THREADED



Code	Finish	Size (mm)	Thread Length (mm)	Head Size A/F (mm)	Box Qty
BXZHT08050	BZP (HT Steel)	M8 x 50	22	13	100
BXZHT08060		M8 x 60	22	13	100
BXZHT08070		M8 x 70	22	13	100
BXZHT08080		M8 x 80	22	13	100
BXZHT08100		M8 x 100	22	13	100
BXZHT10040		M10 x 40	26	17	100
BXZHT10050		M10 x 50	26	17	100
BXZHT10060		M10 x 60	26	17	100
BXZHT10070		M10 x 70	26	17	100
BXZHT10080		M10 x 80	26	17	50
BXZHT10090		M10 x 90	26	17	50
BXZHT10100		M10 x 100	26	17	50
BXZHT10110		M10 x 110	26	17	50
BXZHT10120		M10 x 120	26	17	50
BXZHT10130		M10 x 130	32	17	50
BXZHT10150		M10 x 150	32	17	50
BXZHT10180		M10 x 180	32	17	50
BXZHT12040		M12 x 40	30	19	100
BXZHT12050		M12 x 50	30	19	50
BXZHT12065		M12 x 65	30	19	50
BXZHT12070		M12 x 70	30	19	50
BXZHT12080		M12 x 80	30	19	50
BXZHT12090		M12 x 90	30	19	50
BXZHT12100		M12 x 100	30	19	50
BXZHT12110		M12 x 110	30	19	50
BXZHT12120		M12 x 120	30	19	50
BXZHT12130		M12 x 130	36	19	50
BXZHT12150		M12 x 150	36	19	50
BXZHT12180		M12 x 180	36	19	50
BXZHT12200		M12 x 200	36	19	50
BXZHT16050		M16 x 50	38	24	25
BXZHT16065		M16 x 65	38	24	25
BXZHT16090		M16 x 90	38	24	25
BXZHT16100		M16 x 100	38	24	25
BXZHT16150		M16 x 150	44	24	10
BXZHT16180		M16 x 180	44	24	10
BXZHT16200		M16 x 200	44	24	10

	A (Head Size A/F) (mm)	B (mm)	C (mm)	D (mm)
M6	10	11.05	4	5.82-6
M8	13	14.38	5.5	7.78-8
M10	17	18.90	7	9.78-10
M12	19	21.10	8	11.73-12
M14	22	24.48	9	13.73-14
M16	24	26.75	10	15.73-16

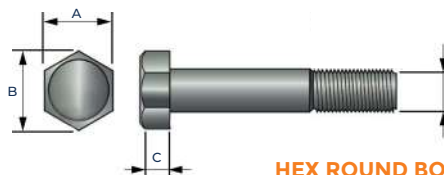

HEX ROUND BOLTS (DIN 931)



### MUSHROOM HEAD ROOFING BOLTS

#### CORE USE

- Ideal for clamping thin sheet metal, plastic and wood
- The flat seating surface under the head makes these bolts ideal for fixing thin section materials

#### MATERIAL

- Bright Zinc Plated (BZP) for corrosion resistance

**HEAD**  
LARGE MUSHROOM HEAD WITH LARGE DIAMETER AND GREATER BEARING SURFACE

**THREAD**  
METRIC COARSE THREAD FULLY THREADED UP TO AT LEAST 100MM



COMES WITH HEX NUT (DIN 934)

Code	Finish	Size (mm)	Box Qty
BRBZ06012	BZP	M6 x 12	200
BRBZ06016		M6 x 16	200
BRBZ06020		M6 x 20	200
BRBZ06025		M6 x 25	200
BRBZ06030		M6 x 30	200
BRBZ06035		M6 x 35	100
BRBZ06040		M6 x 40	100
BRBZ06050		M6 x 50	100
BRBZ06060		M6 x 60	100
BRBZ06070		M6 x 70	100
BRBZ06080		M6 x 80	100
BRBZ06100		M6 x 100	100
BRBZ08012		M8 x 12	100
BRBZ08016		M8 x 16	100
BRBZ08020		M8 x 20	100
BRBZ08025		M8 x 25	100
BRBZ08030		M8 x 30	100
BRBZ08040		M8 x 40	100
BRBZ08050		M8 x 50	100
BRBZ08060		M8 x 60	100
BRBZ08070		M8 x 70	50
BRBZ08080		M8 x 80	50
BRBZ08100		M8 x 100	50
BRBZ08120		M8 x 120	50
BRBZ08140		M8 x 140	50
BRBZ08160		M8 x 160	50
BRBZ08180		M8 x 180	50
BRBZ08200		M8 x 200	50
BRBZ08220		M8 x 220	50
BRBZ10080		M10 x 80	50
BRBZ10100		M10 x 100	50
BRBZ10120		M10 x 120	50
BRBZ10140	M10 x 140	50	
BRBZ10160	M10 x 160	50	
BRBZ10180	M10 x 180	50	
BRBZ10200	M10 x 200	50	
BRBZ10220	M10 x 220	50	
BRBZ10240	M10 x 240	50	

### GUTTER BOLTS & NUTS

#### CORE USE

- Mostly used for joining metal to metal, but also ideal for other construction materials
- Secure holding, reduced damage to material

#### MATERIAL

- Conforms to DIN 963
- Bright Zinc Plated (BZP) for corrosion resistance

**HEAD**  
COUNTERSUNK FOR A FLUSH FINISH, SLOTTED HEAD FOR EASY INSERTION AND REMOVAL

**THREAD**  
FULLY THREADED METRIC COARSE THREAD



COMES WITH HEX NUT (DIN 934)

Code	Finish	Size (mm)	Box Qty
BGBZ06012	BZP	M6 x 12	200
BGBZ06020		M6 x 20	200
BGBZ06025		M6 x 25	200
BGBZ06030		M6 x 30	200
BGBZ06035		M6 x 35	200
BGBZ06040		M6 x 40	200
BGBZ06050		M6 x 50	200
BGBZ06060		M6 x 60	200
BGBZ06070		M6 x 70	200
BGBZ06080		M6 x 80	200
BGBZ06100		M6 x 100	200
BGBZ08020		M8 x 20	200
BGBZ08025		M8 x 25	200
BGBZ08030		M8 x 30	200
BGBZ08035		M8 x 35	200
BGBZ08040		M8 x 40	200
BGBZ08050		M8 x 50	200
BGBZ08060		M8 x 60	200
BGBZ08070		M8 x 70	200
BGBZ08080		M8 x 80	200
BGBZ08100		M8 x 100	200

### HOOK BOLTS & NUTS

#### CORE USE

- Ideal for fixing corrugated roofing sheets to channel and angle iron purlins
- Use with plastic roofing washers and tophats

#### MATERIAL

- Zinc & Yellow Passivated (ZYP) provides middle level protection against rust and corrosion



COMES WITH SQUARE NUT

Code	Finish	Size (mm)	Box Qty
BHBZ08100	ZINC & YELLOW	M8 x 100	100
BHBZ08120		M8 x 120	100
BHBZ08140		M8 x 140	100
BHBZ08160		M8 x 160	100
BHBZ08180		M8 x 180	100
BHBZ08200		M8 x 200	100
BHBZ08220		M8 x 220	100

## STUDDING

Also known as "threaded rod".

### CORE USE

- Ideal for post fixing, suspended ceilings or wall brackets
- Can be sawn

### MATERIAL

- Conforms to DIN 975
- Bright Zinc Plated (BZP) Grade 4.8 mild steel
- High tensile BZP Grade 8.8 steel where high strength is needed
- A2 Stainless Steel Grade 304 for ultimate corrosion resistance

**THREAD**  
FULLY THREADED  
METRIC COARSE THREAD



PREPACKED NUTS & WASHERS AND STUDDING CONNECTORS ALSO AVAILABLE TO ACCOMPANY THE STUDDING

Code	Finish	End Colour	Size	Length (m)	Bundle Qty
BSTZ106	BZP (Mild Steel)	Orange	M6	1	50
BSTZ108		Brown	M8	1	25
BSTZ110		Purple	M10	1	25
BSTZ112		Green	M12	1	25
BSTZ114		Blue	M14	1	10
BSTZ116		Red	M16	1	10
BSTZ120		White	M20	1	5
BSTZ124		Yellow	M24	1	1
BSTZ130		None	M30	1	1
BSTZ206		-	M6	2	25
BSTZ208		-	M8	2	20
BSTZ210		-	M10	2	15
BSTZ212		-	M12	2	10
BSTZ216		-	M16	2	5
BSTZ220		-	M20	2	5
BSTZ224		-	M24	2	1
BSTZ230		-	M30	2	1
BSTZ306		-	M6	3	25
BSTZ308		-	M8	3	20
BSTZ310		-	M10	3	15
BSTZ312	-	M12	3	10	
BSTZ316	-	M16	3	5	
BSTZ320	-	M20	3	5	
BSTZ324	-	M24	3	1	
BSTZ330	-	M30	3	1	
BSTZHT106	BZP (HT Steel)	-	M6	1	1
BSTZHT108		-	M8	1	1
BSTZHT110		-	M10	1	1
BSTZHT112		-	M12	1	1
BSTZHT116		-	M16	1	1
BSTZHT120	-	M20	1	1	
BSTST06	A2 STAINLESS STEEL	-	M6	1	1
BSTST08		-	M8	1	1
BSTST10		-	M10	1	1
BSTST12		-	M12	1	1
BSTST16		-	M16	1	1
BSTST20		-	M20	1	1



## MACHINE SCREWS - BOXED

### CORE USE

- Widely used for holding small machinery parts together using nuts or for fastening components where the rearmost component itself is threaded and acts like a nut

### MATERIAL

- Conforms to DIN 7985
- Bright Zinc Plated (BZP) mild steel CR3 Grade 4.8

**THREAD**  
FULLY THREADED  
METRIC COARSE  
THREAD

**HEAD**  
POZI RECESSED  
PAN OR CSK HEAD

PAN HEAD



COUNTERSUNK HEAD



PAN HEAD	CSK HEAD	Finish	Size (mm)	Box Qty
Code				
BMP3025	BMC3025	BZP	M3 x 25	200
BMP3030	BMC3030		M3 x 30	200
BMP3040	BMC3040		M3 x 40	200
BMP3050	BMC3050		M3 x 50	200
BMP4025	BMC4025		M4 x 25	200
BMP4030	BMC4030		M4 x 30	200
BMP4040	BMC4040		M4 x 40	200
BMP4050	BMC4050		M4 x 50	200
BMP5025	BMC5025		M5 x 25	200
BMP5030	BMC5030		M5 x 30	200
BMP5040	BMC5040		M5 x 40	200
BMP5050	BMC5050		M5 x 50	200

## CLAMPAQ MACHINE SCREWS WITH HEX NUTS & FORM A WASHERS

CLEAR EUROSLOTTED CLAMS AVAILABLE OFF THE SHELF IDEAL FOR SMALL JOBS/DIY SOLD IN OUTERS

## MACHINE SCREWS - CLAMPAQ

Image	Finish	Head Type	Size (mm)	CLAMPAQ Qty	
				Outer Qty	
	BZP	Pan Head	M3 x 25	25no	
B6MP30025			M3 x 30	20no	
B6MP30030			M3 x 40	15no	
B6MP30040			M3 x 50	10no	
B6MP30050			M4 x 25	20no	
B6MP40025			M4 x 30	20no	
B6MP40030			M4 x 40	15no	
B6MP40040			M4 x 50	10no	
B6MP40050			M5 x 25	15no	
B6MP50025			M5 x 30	15no	
B6MP50030			M5 x 40	10no	
B6MP50040			M5 x 50	10no	
B6MP50050					

CLAMPAQ

### HEX FULL NUTS

#### CORE USE

- Most popular and traditional nut type which can be fitted with a spanner or socket
- Can be used with any of our metric bolts

#### MATERIAL

- Conforms to DIN 934
- Bright Zinc Plated (BZP) high tensile steel, Grade 8.8
- A2 Stainless Steel for ultimate corrosion resistance

#### THREAD

COARSE, METRIC  
DOUBLE CHAMFERED,  
SO IT CAN BE EASILY  
FASTENED TO THE ROD



Code	Finish	Size	External Size A/F (mm)	Box Qty	
BXNZ03	BZP (HT STEEL)	M3	5.5	500	
BXNZ04		M4	7	500	
BXNZ05		M5	8	500	
BXNZ06		M6	10	200	
BXNZ08		M8	13	200	
BXNZ10		M10	17	100	
BXNZ12		M12	19	100	
BXNZ14		M14	22	100	
BXNZ16		M16	24	50	
BXNZ20		M20	30	50	
BXNZ24		M24	36	25	
BXNZ30		M30	46	10	
BXNST06		A2 STAINLESS STEEL	M6	10	100
BXNST08			M8	13	100
BXNST10	M10		17	100	
BXNST12	M12		19	100	
BXNST16	M16		24	50	
BXNST20	M20		30	50	

### WING NUTS

#### CORE USE

- For use where regular, simple adjustments may be required - the wings enable them to be turned easily by hand

#### MATERIAL

- Bright Zinc Plated (BZP) for corrosion resistance



Code	Finish	Size	Box Qty
BWNZ005	BZP	M5	200
BWNZ006		M6	200
BWNZ008		M8	100
BWNZ010		M10	100
BWNZ012		M12	100

### TIMBER CONNECTORS

#### CORE USE

- For all applications to enhance bolt performance by reducing timber rotation and joint movement
- Place between timbers on a bolt prior to tightening

#### MATERIAL

- Bright Zinc Plated (BZP) for corrosion resistance

#### DOUBLE SIDED



#### SINGLE SIDED



Code	Finish	Type	Size	External Size (mm)	Box Qty
BTCB050	BZP	Double Sided	M12	50	100
BTCS050		Single Sided	M12	50	100

### HEX NYLON INSERT NUTS

Popular nuts fitted with a polymer insert. The fastener threads into the nylon material and then "self locks", preventing loosening.

#### CORE USE

- Can be used in all bolting and fastening applications

#### MATERIAL

- Conforms to DIN 985
- Bright Zinc Plated (BZP) high tensile steel, Grade 8.8
- A2 Stainless Steel for ultimate corrosion resistance

#### THREAD

COARSE, METRIC TYPE T



Code	Finish	Size	External Size A/F (mm)	Box Qty
BXNZY06	BZP	M6	10	200
BXNZY08		M8	13	200
BXNZY10		M10	17	100
BXNZY12		M12	19	100
BXNZY14		M14	22	100
BXNZY16		M16	24	50
BXNZY20		M20	30	25
BXNZY24		M24	36	25
BXNZY30		M30	46	10
BXNSTY06		A2 STAINLESS STEEL	M6	10
BXNSTY08	M8		13	200
BXNSTY10	M10		17	100
BXNSTY12	M12		19	100

### STUDDING CONNECTORS

Also known as "connection nuts".

#### CORE USE

- Long hexagon nut studding connectors for joining lengths of studding or continuous threaded rods

#### MATERIAL

- Bright Zinc Plated (BZP) for corrosion resistance



Code	Finish	Size	Box Qty
BSCZ06	BZP	M6	50
BSCZ08		M8	50
BSCZ10		M10	25
BSCZ12		M12	25
BSCZ16		M16	10
BSCZ20		M20	10



## LIGHT STEEL WASHERS FORM A

### CORE USE

- Most commonly used light washer
- Round flat washers, used under the head of a bolt or nut to distribute the forces applied when tightening

### MATERIAL

- Dimensions to DIN 125/BS4320 Form A
- Bright Zinc Plated (BZP) mild steel
- A2 Stainless Steel Grade 304 for ultimate corrosion resistance

DIAMETER  
SLIGHTLY LARGER  
THAN THE EQUIVALENT  
HEX BOLT HEAD



Code	Finish	Size	External Diameter A/F (mm)	Thickness (mm)	Box Qty	
BLWZ003	BZP	M3	7	0.5	500	
BLWZ004		M4	9	0.8	500	
BLWZ005		M5	10	1.0	500	
BLWZ006		M6	12.5	1.6	200	
BLWZ008		M8	17	1.6	100	
BLWZ010		M10	21	2.0	100	
BLWZ012		M12	24	2.5	100	
BLWZ014		M14	28	2.5	100	
BLWZ016		M16	30	3.0	100	
BLWZ020		M20	37	3.0	100	
BLWZ024		M24	44	4.0	50	
BLWZ030		M30	56	4.0	50	
BLWST006		A2 STAINLESS STEEL	M6	12.5	1.6	200
BLWST008			M8	17	1.6	100
BLWST010	M10		21	2.0	100	
BLWST012	M12		24	2.5	100	
BLWST016	M16		30	3.0	100	
BLWST020	M20		37	3.0	100	

## MUDGUARD WASHERS

Also known as "penny washers".

### CORE USE

- Used in applications where a large surface area needs to be secured
- Commonly used to spread the load on thin sheet metal

### MATERIAL

- Bright Zinc Plated (BZP) mild steel
- A2 Stainless Steel Grade 304 for ultimate corrosion resistance

DIAMETER  
LARGER THAN  
STANDARD WASHERS



Code	Finish	Size	External Diameter (mm)	Thickness (mm)	Box Qty	
BWMZ05020	BZP	M5	20	1.5	100	
BWMZ05025		M5	25	1.5	100	
BWMZ06020		M6	20	1.5	100	
BWMZ06025		M6	25	1.5	100	
BWMZ06030		M6	30	1.5	100	
BWMZ06040		M6	40	1.5	100	
BWMZ08025		M8	25	1.5	100	
BWMZ08030		M8	30	1.5	100	
BWMZ08040		M8	40	1.5	100	
BWMZ10025		M10	25	1.5	100	
BWMZ10030		M10	30	1.5	100	
BWMZ10040		M10	40	1.5	100	
BWMZ12040		M12	40	1.5	50	
BWMZ12050		M12	50	1.5	50	
BWMST06020		A2 STAINLESS STEEL	M6	20	1.5	100
BWMST08030			M8	30	1.5	100
BWMST10030			M10	30	1.5	100
BWMST12040			M12	40	1.5	50

## HEAVY STEEL WASHERS FORM C

### CORE USE

- Used under the head of a bolt or nut to distribute the forces applied when tightening

### MATERIAL

- Dimensions to BS4320 Form C
- Bright Zinc Plated (BZP) mild steel
- A2 Stainless Steel Grade 304 for ultimate corrosion resistance

DIAMETER  
SLIGHTLY LARGER  
THAN THE EQUIVALENT  
HEX BOLT HEAD



Code	Finish	Size	External Diameter A/F (mm)	Thickness (mm)	Box Qty
BRWZ06	BZP	M6	14	1.6	200
BRWZ08		M8	21	1.6	100
BRWZ10		M10	24	2.0	100
BRWZ12		M12	28	2.5	100
BRWZ14		M14	30	2.5	100
BRWZ16		M16	34	3.0	50
BRWZ20		M20	39	3.0	50
BRWST06		A2 STAINLESS STEEL	M6	14	1.6
BRWST08	M8		21	1.6	100
BRWST10	M10		24	2.0	100
BRWST12	M12		28	2.5	100
BRWST16	M16		34	3.0	50
BRWST20	M20		39	3.0	50

## SQUARE PLATE WASHERS

### CORE USE

- Used with all fasteners for larger load distribution (e.g. bolting through a wall)

### MATERIAL

- Bright Zinc Plated (BZP) mild steel
- A2 Stainless Steel Grade 304 for ultimate corrosion resistance



Code	Finish	Size	External Size (mm)	Thickness (mm)	Box Qty
BSWZ3404008	BZP	M8	40x40	3.0	100
BSWZ3404010		M10	40x40	3.0	100
BSWZ3404012		M12	40x40	3.0	100
BSWZ3505010		M10	50x50	3.0	50
BSWZ3505012		M12	50x50	3.0	50
BSWZ3505016		M16	50x50	3.0	50
BSWZ3505020		M20	50x50	3.0	50
BSWST010		A2 STAINLESS STEEL	M10	50x50	3.0
BSWST012	M12		50x50	3.0	50



## DIAMOND CURVED WASHERS

### CORE USE

- Used when fixing corrugated profile sheets with drive screws or hook bolts

### MATERIAL

- Bright Zinc Plated (BZP) for corrosion resistance
- Round hole



Code	Finish	Size	External Size (mm)	Thickness (mm)	Box Qty
BDCW06	BZP	M6	40x40	1.5	100
BDCW08		M8	40x40	1.5	100

## PLASTIC ROOFING WASHERS

Also known as "spat washers".

### CORE USE

- Provide an effective weather seal on fibre cement and metal sheeting
- The washers are designed to exert ever increasing sealing pressure at the washer rim whilst the fixing is being tightened

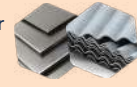

### MATERIAL

- Black thermo-plastic

Code	Colour	Size	Box Qty
BRWP006	BLACK	M6	100
BRWP008		M8	100

## SHAKEPROOF WASHERS

Internal overlapping tooth shakeproof washers.

### CORE USE

- Used where the appearance warrants that the teeth be hidden

### MATERIAL

- Bright Zinc Plated (BZP) for corrosion resistance

**TEETH**  
INCREASE THE INTEGRITY & SECURITY OF THE ASSEMBLY



Code	Finish	Size	Box Qty
BSHW06	BZP	M6	200
BSHW08		M8	100
BSHW10		M10	100
BSHW12		M12	100

## PLASTIC TOPHATS

Also known as "spat tophats".

### CORE USE

- Covers the fixing that protrudes through the washer (e.g. hook bolt)
- Use with plastic roofing washers

### MATERIAL

- Black thermo-plastic



Code	Colour	Size	Box Quantity
BRWPTH08	BLACK	M8	100

## SPRING WASHERS

### CORE USE

- Lock washers place tension against a nut after tightening to prevent the nut from loosening

### MATERIAL

- Bright Zinc Plated (BZP) for corrosion resistance
- Square section ends - conforms to DIN 7980



Code	Finish	Size	Box Qty
BSPWZ06	BZP	M6	200
BSPWZ08		M8	100
BSPWZ10		M10	100
BSPWZ12		M12	100

### SPRING WASHERS (DIN 7980)

	M6	M8	M10	M12
$d_1$	6 mm (6.1-6.5)	8 mm (8.1-8.5)	10 mm (10.2-10.7)	12 mm (12.2-12.7)
$d_2$	max. 9.9 mm	max. 12.7 mm	max. 16 mm	max. 18 mm
$h$	3.2-3.78 mm	4-4.72 mm	5-5.90 mm	5-5.90 mm

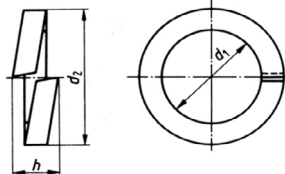

## PLASTIC SEALING WASHERS

Also known as "selawashers".

### CORE USE

- Used when fixing corrugated roof sheeting
- Use in conjunction with plastic sealing covers

### MATERIAL

- Black thermo-plastic



Code	Colour	Size (mm)	Box Qty
BRWPSW06028	BLACK	M6 x 28	100
BRWPSW08028		M8 x 28	100

## PLASTIC SEALING COVERS

Also known as "selacovers".

### CORE USE

- Shallow cover which suits low profile fasteners such as mushroom head roofing bolts or drive screws
- Use with plastic sealing washers

### MATERIAL

- Black thermo-plastic







Code	Colour	Size (mm)	Box Qty
BRWPSC28	BLACK	28	100



PROVIDED IN EUROSLOTTED BAGS  
 JOHN GEORGE BRANDED  
 AVAILABLE OFF THE SHELF  
 EASILY SALEABLE PACK SIZES  
 SOLD IN OUTERS





## COACH SCREWS

	Finish	Head Type	Size (mm)		
				Outer Qty 5	
				BAG Qty	
B4HSZ06040	BZP	Hex Head	M6 x 40	10no	
B4HSZ06050		Hex Head	M6 x 50	10no	
B4HSZ06070		Hex Head	M6 x 70	10no	
B4HSZ06090		Hex Head	M6 x 90	10no	
B4HSZ08040		Hex Head	M8 x 40	10no	
B4HSZ08050		Hex Head	M8 x 50	10no	
B4HSZ08060		Hex Head	M8 x 60	10no	
B4HSZ08070		Hex Head	M8 x 70	5no	
B4HSZ08080		Hex Head	M8 x 80	5no	
B4HSZ08100		Hex Head	M8 x 100	5no	
B4HSZ08120		Hex Head	M8 x 120	5no	
B4HSZ08150		Hex Head	M8 x 150	5no	
B4HSZ10050		Hex Head	M10 x 50	5no	
B4HSZ10060		Hex Head	M10 x 60	5no	
B4HSZ10070		Hex Head	M10 x 70	5no	
B4HSZ10080		Hex Head	M10 x 80	5no	
B4HSZ10100		Hex Head	M10 x 100	5no	
B4HSZ10130		Hex Head	M10 x 130	5no	
B4HSZ10150		Hex Head	M10 x 150	5no	
B4HSZ12050		Hex Head	M12 x 50	5no	
B4HSZ12080		Hex Head	M12 x 80	5no	
B4HSZ12100		Hex Head	M12 x 100	5no	
B4HSZ12120		Hex Head	M12 x 120	5no	
B4HSZ12140		Hex Head	M12 x 140	5no	
B4HSZ12180		Hex Head	M12 x 180	5no	
		Finish	Head Type	Size (mm)	
					Outer Qty 1
				BAG Qty	
B4HST08040	A2 STAINLESS STEEL	Hex Head	M8 x 40	10no	
B4HST08050		Hex Head	M8 x 50	10no	
B4HST08070		Hex Head	M8 x 70	5no	
B4HST08100		Hex Head	M8 x 100	5no	
B4HST10050		Hex Head	M10 x 50	5no	
B4HST10070		Hex Head	M10 x 70	5no	
B4HST10080		Hex Head	M10 x 80	5no	
B4HST10100		Hex Head	M10 x 100	5no	
B4HST10120		Hex Head	M10 x 120	5no	
B4HST10130		Hex Head	M10 x 130	5no	
B4HST10150		Hex Head	M10 x 150	5no	
B4HST12050		Hex Head	M12 x 50	5no	
B4HST12070		Hex Head	M12 x 70	5no	
B4HST12080		Hex Head	M12 x 80	5no	
B4HST12100		Hex Head	M12 x 100	5no	
B4HST12120		Hex Head	M12 x 120	5no	
B4HST12140		Hex Head	M12 x 140	5no	



## CUP SQUARE HEX BOLTS & NUTS

	Finish	Head Type	Size (mm)	
				Outer Qty 5
				BAG Qty
B4CSZ06025	BZP	Domed Head	M6 x 25	10no
B4CSZ06040		Domed Head	M6 x 40	10no
B4CSZ06050		Domed Head	M6 x 50	10no
B4CSZ06065		Domed Head	M6 x 65	10no
B4CSZ06075		Domed Head	M6 x 75	10no
B4CSZ06100		Domed Head	M6 x 100	6no
B4CSZ08030		Domed Head	M8 x 30	6no
B4CSZ08050		Domed Head	M8 x 50	6no
B4CSZ08075		Domed Head	M8 x 75	6no
B4CSZ08100		Domed Head	M8 x 100	6no
B4CSZ08130		Domed Head	M8 x 130	4no
B4CSZ08150		Domed Head	M8 x 150	4no
B4CSZ10075		Domed Head	M10 x 75	4no
B4CSZ10100		Domed Head	M10 x 100	4no
B4CSZ10110		Domed Head	M10 x 110	4no
B4CSZ10130		Domed Head	M10 x 130	4no
B4CSZ10150		Domed Head	M10 x 150	4no
B4CSZ10180		Domed Head	M10 x 180	4no
B4CSZ10200		Domed Head	M10 x 200	4no
B4CSZ12050		Domed Head	M12 x 50	4no
B4CSZ12075		Domed Head	M12 x 75	4no
B4CSZ12100		Domed Head	M12 x 100	4no
B4CSZ12110		Domed Head	M12 x 110	4no
B4CSZ12130		Domed Head	M12 x 130	4no
B4CSZ12150		Domed Head	M12 x 150	4no
B4CSZ12180		Domed Head	M12 x 180	4no
B4CSZ12200		Domed Head	M12 x 200	4no
		Finish	Head Type	Size (mm)
	Outer Qty 1			
				BAG Qty
B4CST08050	A2 STAINLESS STEEL	Domed Head	M8 x 50	6no
B4CST08065		Domed Head	M8 x 65	6no
B4CST08080		Domed Head	M8 x 80	6no
B4CST08100		Domed Head	M8 x 100	6no
B4CST08110		Domed Head	M8 x 110	6no
B4CST08130		Domed Head	M8 x 130	4no
B4CST08150		Domed Head	M8 x 150	4no
B4CST10050		Domed Head	M10 x 50	4no
B4CST10065		Domed Head	M10 x 65	4no
B4CST10080		Domed Head	M10 x 80	4no
B4CST10100		Domed Head	M10 x 100	4no
B4CST10110		Domed Head	M10 x 110	4no
B4CST10130		Domed Head	M10 x 130	4no
B4CST10150		Domed Head	M10 x 150	4no
B4CST10180		Domed Head	M10 x 180	4no
B4CST10200		Domed Head	M10 x 200	4no
B4CST12080		Domed Head	M12 x 80	4no
B4CST12100		Domed Head	M12 x 100	4no
B4CST12110		Domed Head	M12 x 110	4no
B4CST12130		Domed Head	M12 x 130	4no
B4CST12150	Domed Head	M12 x 150	4no	



### HEX SET SCREWS & HEX NUTS

	Finish	Head Type	Size (mm)	
				Outer Qty 5
				BAG Qty
B4XSZ06025	BZP	Hex Head	M6 x 25	12no
B4XSZ06040		Hex Head	M6 x 40	10no
B4XSZ06050		Hex Head	M6 x 50	10no
B4XSZ08025		Hex Head	M8 x 25	10no
B4XSZ08040		Hex Head	M8 x 40	8no
B4XSZ08050		Hex Head	M8 x 50	8no
B4XSZ08080		Hex Head	M8 x 80	6no
B4XSZ10025		Hex Head	M10 x 25	8no
B4XSZ10050		Hex Head	M10 x 50	6no
B4XSZ10080		Hex Head	M10 x 80	4no
B4XSZ10100		Hex Head	M10 x 100	4no
B4XSZ12040		Hex Head	M12 x 40	6no
B4XSZ12050		Hex Head	M12 x 50	6no
B4XSZ12080		Hex Head	M12 x 80	4no
B4XSZ12100		Hex Head	M12 x 100	4no
		Finish	Head Type	Size (mm)
	Outer Qty 1			
				BAG Qty
B4XST06025	A2 STAINLESS STEEL	Hex Head	M6 x 25	12no
B4XST06050		Hex Head	M6 x 50	10no
B4XST08025		Hex Head	M8 x 25	10no
B4XST08050		Hex Head	M8 x 50	8no
B4XST08080		Hex Head	M8 x 80	6no
B4XST08100		Hex Head	M8 x 100	6no
B4XST10025		Hex Head	M10 x 25	8no
B4XST10050		Hex Head	M10 x 50	6no
B4XST10080		Hex Head	M10 x 80	4no
B4XST10100		Hex Head	M10 x 100	4no
B4XST12025		Hex Head	M12 x 25	6no
B4XST12050		Hex Head	M12 x 50	6no
B4XST12080		Hex Head	M12 x 80	4no
B4XST12100		Hex Head	M12 x 100	4no



### MUSHROOM HEAD ROOFING BOLTS & HEX NUTS

	Finish	Head Type	Size (mm)	
				Outer Qty 5
				BAG Qty
B4RBZ06012	BZP	Mushroom	M6 x 12	10no
B4RBZ06020		Mushroom	M6 x 20	10no
B4RBZ06025		Mushroom	M6 x 25	10no
B4RBZ06030		Mushroom	M6 x 30	10no
B4RBZ06040		Mushroom	M6 x 40	10no
B4RBZ06050		Mushroom	M6 x 50	10no
B4RBZ06060		Mushroom	M6 x 60	10no
B4RBZ06080		Mushroom	M6 x 80	10no
B4RBZ06100		Mushroom	M6 x 100	10no
B4RBZ08030		Mushroom	M8 x 30	6no
B4RBZ08050		Mushroom	M8 x 50	6no
B4RBZ08060		Mushroom	M8 x 60	6no
B4RBZ08080		Mushroom	M8 x 80	6no
B4RBZ08100		Mushroom	M8 x 100	6no
B4RBZ08120		Mushroom	M8 x 120	6no
B4RBZ08140		Mushroom	M8 x 140	6no
B4RBZ08160		Mushroom	M8 x 160	6no
B4RBZ10100		Mushroom	M10 x 100	4no
B4RBZ10140		Mushroom	M10 x 140	4no

### GUTTER BOLTS & HEX NUTS

	Finish	Head Type	Size (mm)	
				Outer Qty 5
				BAG Qty
B4GBZ06020	BZP	Countersunk	M6 x 20	10no
B4GBZ06025		Countersunk	M6 x 25	10no
B4GBZ06030		Countersunk	M6 x 30	10no
B4GBZ06040		Countersunk	M6 x 40	10no
B4GBZ06050		Countersunk	M6 x 50	10no



### HEX ROUND BOLTS & HEX NUTS

	Finish	Head Type	Size (mm)	
				Outer Qty 5
				BAG Qty
B4XZHT10110	BZP	Hex Head	M10 x 110	4no
B4XZHT10130		Hex Head	M10 x 130	4no
B4XZHT10150		Hex Head	M10 x 150	4no
B4XZHT12110		Hex Head	M12 x 110	4no
B4XZHT12130		Hex Head	M12 x 130	4no
B4XZHT12150		Hex Head	M12 x 150	4no
B4XZHT12180		Hex Head	M12 x 180	4no
B4XZHT12200		Hex Head	M12 x 200	4no





### HOOK BOLTS & SQUARE NUTS

	Finish	Head Type	Size (mm)	
				Outer Qty 5
				BAG Qty
B4HBZ08080	ZINC & YELLOW	Hook	M8 x 80	4no
B4HBZ08100		Hook	M8 x 100	4no
B4HBZ08120		Hook	M8 x 120	4no
B4HBZ08160		Hook	M8 x 160	4no
B4HBZ08180		Hook	M8 x 180	4no
B4HBZ08200		Hook	M8 x 200	4no



## HEX FULL NUTS

	Finish	Size (mm)	
			Outer Qty 5
			BAG Qty
B4XNZ06	BZP	M6	10no
B4XNZ08		M8	10no
B4XNZ10		M10	10no
B4XNZ12		M12	10no
B4XNZ16		M16	5no
B4XNZ20		M20	5no
	Finish	Size (mm)	
			Outer Qty 1
			BAG Qty
B4XNST06	A2 STAINLESS STEEL	M6	10no
B4XNST08		M8	10no
B4XNST10		M10	10no
B4XNST12		M12	10no

## HEX NYLON INSERT NUTS

	Finish	Size (mm)	
			Outer Qty 5
			BAG Qty
B4XNZY06	BZP	M6	10no
B4XNZY08		M8	10no
B4XNZY10		M10	10no
B4XNZY12		M12	10no
	Finish	Size (mm)	
			Outer Qty 1
			BAG Qty
B4XNSTY06	A2 STAINLESS STEEL	M6	10no
B4XNSTY08		M8	10no
B4XNSTY10		M10	10no
B4XNSTY12		M12	10no

## WING NUTS

	Finish	Size (mm)	
			Outer Qty 5
			BAG Qty
B4WNZ06	BZP	M6	20no
B4WNZ08		M8	10no
B4WNZ10		M10	10no
B4WNZ12		M12	8no





## BAGGED BOLTS, NUTS & WASHERS







**PROVIDED IN EUROSLOTTED BAGS**  
JOHN GEORGE BRANDED  
**AVAILABLE OFF THE SHELF**  
EASILY SALEABLE PACK SIZES  
**SOLD IN OUTERS**



## HEAVY STEEL WASHERS FORM C





	Finish	Size (mm)	
			Outer Qty 5
			BAG Qty
B4RWZ06	BZP	M6	10no
B4RWZ08		M8	10no
B4RWZ10		M10	10no
B4RWZ12		M12	10no
B4RWZ16		M16	5no
B4RWZ20		M20	5no
	Finish	Size (mm)	
			Outer Qty 1
			BAG Qty
B4RWST06	A2 STAINLESS STEEL	M6	10no
B4RWST08		M8	10no
B4RWST10		M10	10no
B4RWST12		M12	10no

## MUDGUARD WASHERS



	Finish	Size (mm)	
			Outer Qty 5
			BAG Qty
B4WMZ06030	BZP	M6 x 30	10no
B4WMZ08030		M8 x 30	10no
B4WMZ10030		M10 x 30	10no
B4WMZ10040		M10 x 40	10no
B4WMZ12038		M12 x 40	10no
B4WMZ12050		M12 x 50	10no
	Finish	Size (mm)	
			Outer Qty 1
			BAG Qty
B4WMST06020	A2 STAINLESS STEEL	M6 x 20	10no
B4WMST08030		M8 x 30	10no
B4WMST10030		M10 x 30	10no
B4WMST12040		M12 x 40	10no



## SQUARE PLATE WASHERS

	Finish	Size (mm)	
			Outer Qty 5
			BAG Qty
B4SWZ1010	BZP	M10	10no
B4SWZ1210		M12	10no
	Finish	Size (mm)	
			Outer Qty 1
			BAG Qty
B4SWST010	A2 STAINLESS STEEL	M10	10no
B4SWST012		M12	10no





## STUDDING CONNECTORS

	Finish	Size (mm)	
			Outer Qty 5
			BAG Qty
B4SCZ06	BZP	M6	1no
B4SCZ08		M8	1no
B4SCZ10		M10	1no
B4SCZ12		M12	1no
B4SCZ16		M16	1no
B4SCZ20		M20	1no

## SPRING WASHERS

	Finish	Size (mm)	
			Outer Qty 5
			BAG Qty
B4SPWZ06030	BZP	M6	10no
B4SPWZ08030		M8	10no
B4SPWZ10030		M10	10no
B4SPWZ12038		M12	10no



## HEX FULL NUTS & HEAVY STEEL WASHERS FORM C

	Finish	Size (mm)	
			Outer Qty 5
			BAG Qty
B4NWZ06	BZP	M6	14no
B4NWZ08		M8	12no
B4NWZ10		M10	8no
B4NWZ12		M12	6no
B4NWZ16		M16	4no
B4NWZ20		M20	2no
	Finish	Size (mm)	
			Outer Qty 5
			BAG Qty
B4NWST06	A2 STAINLESS STEEL	M6	14no
B4NWST08		M8	12no
B4NWST10		M10	8no
B4NWST12		M12	6no
B4NWST16		M16	4no
B4NWST20		M20	2no

## PLASTIC ROOFING WASHERS

	Material	Size (mm)	
			Outer Qty 5
			BAG Qty
B4RWP06	BLACK THERMOPLASTIC	M6	10no
B4RWP08		M8	10no
B4RWP1006		M6	100no
B4RWP1008		M8	100no

## TIMBER CONNECTORS

	Finish	Type	Size (mm)	
				Outer Qty 5
				BAG Qty
B4TCB050	BZP	Double Sided	50	10no

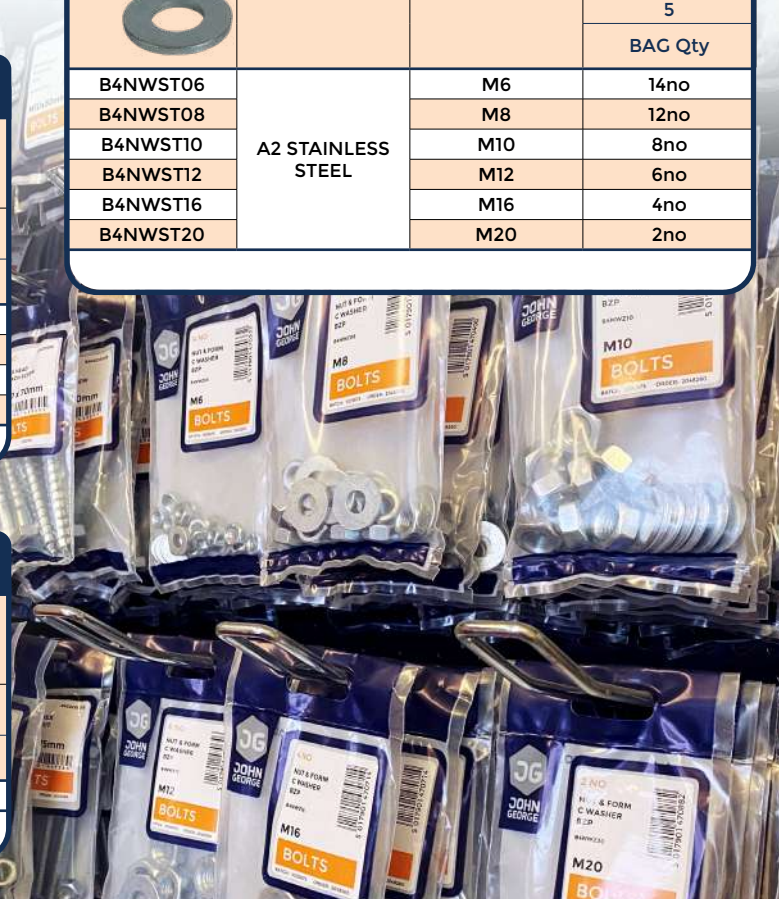

## THUNDERBOLTS

The original and best selling all-purpose anchor.  
Safe anchorage achieved without the need of high tightening forces.  
Can be removed and re-fixed into the same hole, providing the thread is correctly aligned.

### CORE USE

- Concrete
- Brick
- Stone
- Marble
- Wood
- Fixing handrails, post supports, timber battens, satellite dishes
- Can be used by general builders, fencing contractors, property developers and maintenance, shop fitters, plumbers and restoration contractors



**NO EXPANSION FORCES**  
CLOSE TO EDGE FIXING  
& REDUCED CENTRE  
SPACING DISTANCES



D - drill bit diameter  
D1 - clearance drill bit diameter  
H - max. fixture thickness  
H1 - min. embed depth  
H2 - min. over drill depth  
H3 - anchor length  
T - max. tightening torque

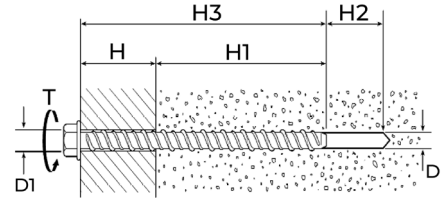

Code	Type	Size (mm)	D (mm)	H (mm)	H1 (mm)	H2 (mm)	D1 (mm)	T (Nm)	H3 (mm)	Washer Size (mm)	Driver Type	Min. Hole Depth (mm)	Box Qty	
MTHFB05050	HEX FLANGE	M5 x 50	5	25	25	10	7	15	50	-	8 A/F	32.5	100	
MTHFB05075		M5 x 75	5	50	25	10	7	15	75	-	8 A/F	32.5	100	
MTHFB05100		M5 x 100	5	63	37	10	7	15	100	-	8 A/F	32.5	100	
MTHFB06050		M6 x 50	6	20	30	10	8	25	50	-	10 A/F	40	100	
MTHFB06075		M6 x 75	6	45	30	10	8	25	75	-	10 A/F	40	100	
MTHFB06100		M6 x 100	6	55	45	10	8	25	100	-	10 A/F	40	100	
MTHFB06130		M6 x 130	6	85	45	10	8	25	130	-	10 A/F	40	100	
MTHFB06150		M6 x 150	6	105	45	10	8	25	150	-	10 A/F	40	100	
MTHB08060	HEX HEAD	M8 x 60	8	20	40	15	10	40	60	10	15 A/F	55	100	
MTHB08075		M8 x 75	8	35	40	15	10	40	75	10	15 A/F	55	100	
MTHB08100		M8 x 100	8	60	40	15	10	40	100	10	15 A/F	55	100	
MTHB08130		M8 x 130	8	90	40	15	10	40	130	10	15 A/F	55	50	
MTHB08150		M8 x 150	8	110	40	15	10	40	150	10	15 A/F	55	50	
MTHB10060		M10 x 60	10	10	50	20	12	60	60	12	17 A/F	70	50	
MTHB10075		M10 x 75	10	25	50	20	12	60	75	12	17 A/F	70	50	
MTHB10100		M10 x 100	10	50	50	20	12	60	100	12	17 A/F	70	50	
MTHB10130		M10 x 130	10	80	50	20	12	60	130	12	17 A/F	70	25	
MTHB10150		M10 x 150	10	100	50	20	12	60	150	12	17 A/F	70	25	
MTHB12075		M12 x 75	12	15	60	25	14	80	75	14	19 A/F	85	50	
MTHB12100		M12 x 100	12	40	60	25	14	80	100	14	19 A/F	85	50	
MTHB12130		M12 x 130	12	70	60	25	14	80	130	14	19 A/F	85	25	
MTHB12150		M12 x 150	12	90	60	25	14	80	150	14	19 A/F	85	20	
MTHB12200		M12 x 200	12	140	60	25	14	80	200	14	19 A/F	85	20	
MTHB16100		M16 x 100	16	20	80	32	20	100	100	18	27 A/F	112	10	
MTHB16150		M16 x 150	16	70	80	32	20	100	150	18	27 A/F	112	10	
MTHB16200		M16 x 200	16	120	80	32	20	100	200	18	27 A/F	112	10	
MTHEB08055		EYE	M8 x 55	8	-	-	-	-	-	-	-	-	-	50
MTHHB08055		HOOK	M8 x 55	8	-	-	-	-	-	-	-	-	-	50
MTHTB05030	CSK TORX	M5 x 30	5	5	25	10	7	15	30	-	T25	32.5	200	
MTHTB05050		M5 x 50	5	25	25	10	7	15	50	-	T25	32.5	100	
MTHTB05075		M5 x 75	5	50	25	10	7	15	75	-	T25	32.5	100	
MTHTB05100		M5 x 100	5	63	37	10	7	15	100	-	T25	32.5	100	
MTHTB06050		M6 x 50	6	20	30	10	8	25	50	-	T30	40	100	
MTHTB06075		M6 x 75	6	45	30	10	8	25	75	-	T30	40	100	
MTHTB06100		M6 x 100	6	55	45	10	8	25	100	-	T30	40	100	
MTHTB06130		M6 x 130	6	85	45	10	8	25	130	-	T30	40	100	
MTHTB06150	M6 x 150	6	105	45	10	8	25	150	-	T30	40	100		

## Thunderbolt Installation Instructions

(Also please see table for relevant dimensions)

1. Drill at right angles using drill bit of same diameter (D) ensuring hole is slightly deeper than the Thunderbolt (H2).
2. Remove any loose dust from the hole.
3. Screw in the Thunderbolt with a socket wrench. Apply slight downward pressure to start the self-tapping action. If an impact wrench is to be used as means of installation it must be torque controlled and the maximum tightening torque must not be exceeded.
4. Tighten the Thunderbolt until the fixture is in place. If resistance is experienced whilst tightening, unscrew one turn and re-tighten, ensuring not to over tighten.
5. For optimum performance, use a torque wrench. Do not exceed maximum tightening torque (T).

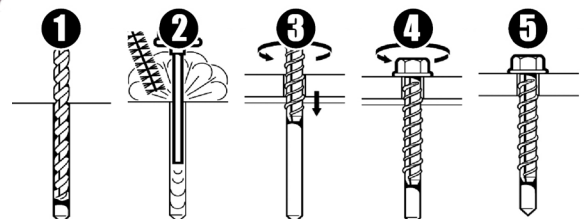

## NUT TYPE SLEEVE ANCHORS

Traditional heavy duty fixing. The fixture can be positioned prior to fixing holes being drilled for ease of use.

### CORE USE

- Concrete
- Brick
- Stone
- Suitable for medium to heavy duty applications such as wall plates, brackets, garage doors and signs

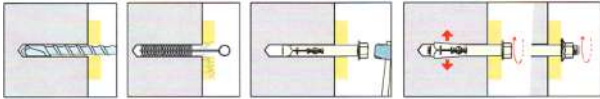

Code	Size (mm)	Drill Hole Dia. (mm)	Max. Fixture Thickness (mm)	Min. Hole Depth (mm)	Box Qty
MSA08040	M8 x 40	8	10	35	100
MSA08065	M8 x 65	8	35	40	50
MSA08085	M8 x 85	8	55	40	50
MSA10050	M10 x 50	10	12	45	50
MSA10077	M10 x 77	10	37	45	50
MSA10097	M10 x 97	10	57	45	50
MSA10125	M10 x 125	10	80	45	50
MSA12075	M12 x 75	12	25	55	50
MSA12099	M12 x 99	12	49	55	25
MSA12129	M12 x 129	12	79	55	25
MSA16111	M16 x 111	16	65	60	20

## THROUGH BOLTS

Traditional medium to heavy duty fixing. The fixture can be positioned prior to fixing holes being drilled for ease of use.

### CORE USE

- Concrete
- Ideal for fixing storage racking, holding down steel structures and safety fences
- A torque controlled through fixing suitable for medium to heavy duty work

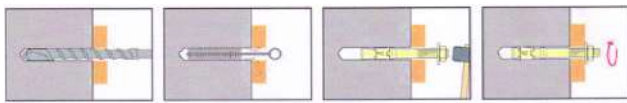

Code	Size (mm)	Drill Hole Dia. (mm)	Max. Fixture Thickness (mm)	Min. Hole Depth (mm)	Box Qty
MTB06085	M6 x 85	6	45	35	100
MTB08050	M8 x 50	8	5	40	100
MTB08075	M8 x 75	8	30	40	100
MTB08095	M8 x 95	8	50	40	100
MTB08115	M8 x 115	8	75	40	100
MTB10080	M10 x 80	10	15	50	50
MTB10100	M10 x 100	10	35	50	50
MTB10120	M10 x 120	10	65	50	50
MTB12080	M12 x 80	12	5	65	50
MTB12100	M12 x 100	12	25	65	50
MTB12120	M12 x 120	12	45	65	25
MTB12140	M12 x 140	12	65	65	25
MTB12180	M12 x 180	12	105	65	25
MTB16125	M16 x 125	16	30	85	20

## SHIELD ANCHORS

Traditional masonry fixings also known as "wallbolts".

### CORE USE

- Concrete
- Brick
- Stone
- Diameters up to M12 are designed for use in solid brickwork and stonework
- Ideal for medium duty non-critical applications such as garage door and door frames, holding down machinery, racking, seating, electrical and plumbing fitting
- Projecting bolt anchors lend themselves to wall applications whilst loose bolt anchors are ideal for floor applications
- Hook and eye shield anchors come assembled and provide an anchor point for the tying down or the hanging of fixtures and fittings
- Shields can be used with threaded rod and alternative sizes of bolts



PROJECTING BOLT

LOOSE BOLT

HOOK BOLT

EYE BOLT

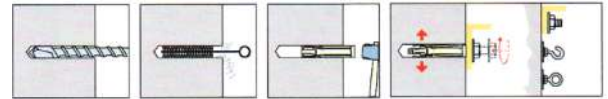

Code	Type	Size (mm)	Drill Hole Dia. (mm)	Min. Hole Depth (mm)	Fixture Thickness (mm)	Box Qty
MSP06010	PROJ. BOLT	M6 x 10	10	40	10	25
MSP06025		M6 x 25	10	40	25	25
MSP06060		M6 x 60	10	40	60	25
MSP08010		M8 x 10	14	50	10	25
MSP08025		M8 x 25	14	50	25	25
MSP08040		M8 x 40	14	50	40	25
MSP08060		M8 x 60	14	50	60	25
MSP08080		M8 x 80	14	50	80	25
MSP10015		M10 x 15	16	60	15	25
MSP10030		M10 x 30	16	60	30	25
MSP10060		M10 x 60	16	60	60	25
MSP10070		M10 x 70	16	60	70	25
MSP10090		M10 x 90	16	60	90	25
MSP12015		M12 x 15	20	80	15	25
MSP12030		M12 x 30	20	80	30	25
MSP12075		M12 x 75	20	80	75	10
MSP16035	M16 x 35	25	105	35	10	
MSL06010	LOOSE BOLT	M6 x 10	10	40	10	25
MSL06025		M6 x 25	10	40	25	25
MSL06040		M6 x 40	10	40	40	25
MSL08010		M8 x 10	14	50	10	25
MSL08025		M8 x 25	14	50	25	25
MSL08040		M8 x 40	14	50	40	25
MSL10010		M10 x 10	16	60	10	25
MSL10025		M10 x 25	16	60	25	25
MSL10050		M10 x 50	16	60	50	25
MSL10075		M10 x 75	16	60	75	25
MSL12010		M12 x 10	20	80	10	25
MSL12025		M12 x 25	20	80	25	25
MSL12040		M12 x 40	20	80	40	25
MSL12060		M12 x 60	20	80	60	25
MSL16015	M16 x 15	25	105	15	10	
MSL16030	M16 x 30	25	105	30	10	
MHWB08060	HOOK BOLT	M8 x 60	14	-	-	25
MEWB08060	EYE BOLT	M8 x 60	14	-	-	25
MRSA08	SHIELD ONLY	M8 x 50	14	-	-	50
MRSA10		M10 x 60	16	-	-	50
MRSA12		M12 x 72	20	-	-	25



## HAMMER FIXINGS

### CORE USE

- Concrete
- Brick
- Stone
- Ideal for repetitive tasks where speed of installation is important such as wooden battens, door and window frames, skirting boards, wall plates and signs



Code	Size (mm)	Drill Hole Dia. (mm)	Max. Fixture Thickness (mm)	Min. Hole Depth (mm)	Box Qty
MHF06040	M6 x 40	6	10	35	200
MHF06060	M6 x 60	6	30	35	100
MHF06080	M6 x 80	6	50	35	100
MHF08060	M8 x 60	8	20	45	100
MHF08080	M8 x 80	8	40	45	100
MHF08100	M8 x 100	8	60	45	100
MHF08120	M8 x 120	8	80	45	100
MHF10100	M10 x 100	10	50	60	100
MHF10140	M10 x 135	10	85	60	50
MHF10160	M10 x 160	10	110	60	50

## CHEMICAL INJECTION POLYESTER RESIN

Safe system for stress-free anchoring of building materials.

### CORE USE

- Concrete
- Brick
- Stone
- Hollow masonry
- Polyester resin cartridges come complete with one mixer nozzle but spare mixer nozzles available to buy separately
- Full instructions on pack



Code	Product	Capacity (ml)	Gun Type	Pack Qty
MCIPR300	Polyester Resin	300	Standard C3/C4	12
MCIPR410	Polyester Resin	410	MCIG380	12
MCIG380	Applicator Gun	410	-	1

## FRAME FIXINGS

### CORE USE

- Concrete
- Brick
- Stone
- Suitable for door, window and structural frames, wooden battens, fence posts, racking and shelving

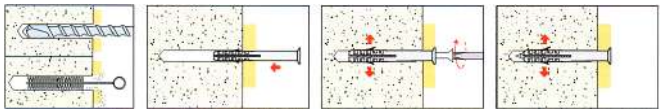

Code	Size (mm)	Drill Hole Dia. (mm)	Max. Fixture Thickness (mm)	Min. Hole Depth (mm)	Box Qty
MFF08060	M8 x 60	8	20	45	100
MFF08080	M8 x 80	8	40	45	100
MFF08100	M8 x 100	8	60	45	100
MFF08120	M8 x 120	8	80	45	100
MFF08135	M8 x 135	8	100	45	50
MFF10080	M10 x 80	10	30	50	50
MFF10100	M10 x 100	10	50	50	50
MFF10115	M10 x 115	10	65	50	50
MFF10135	M10 x 135	10	85	50	50
MFF10160	M10 x 160	10	110	50	50

## CHEMICAL INJECTION SPARE MIXER NOZZLES

### CORE USE

- With Chemical Injection Resin cartridges - both 300ml & 410ml

AVAILABLE BOXED OR IN JOHN GEORGE EUROSLOTTED BRANDED BAGS



Code	Product	Capacity (ml)	Pack Type	Pack Qty	Outer Qty
MCIMN	Mixer Nozzles	Fits all	Boxed	10	1
M8CIMN	Mixer Nozzles	Fits all	Bagged	2	5

## CHEMICAL INJECTION RESIN STUDS

Zinc plated studs for use with chemical injection polyester resin.

### CORE USE

- Concrete
- Brick
- Stone
- Hollow masonry

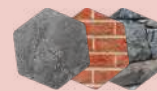

COMES WITH NUT AND WASHER

Code	Size (mm)	Drill Hole Dia. (mm)	Hole Depth (mm)	Polyester Resin (300ml)	Polyester Resin (410ml)	Box Qty
MCSZ08	M8 x 110	10	80	85no	110no	10
MCSZ10	M10 x 130	12	90	45no	60no	10
MCSZ12	M12 x 160	14	110	30no	40no	10
MCSZ16	M16 x 190	18	125	15no	20no	10
MCSZ20	M20 x 260	25	170	7no	9no	10

The table includes the number of fixings that can be done with the 300ml and the 410ml polyester resin cartridges



Hammer & Frame Fixings also available **prepacked** in **Bagged Fixings**



# IMPACT MASONRY SCREWS

## HEAD TYPE

COUNTERSUNK TORX (T30) FOR MORE GRIP  
EASY TO FIX

## THREAD

COARSE THREAD TO PROVIDE PLENTY OF GRIP  
SERRATED TO MAKE DRIVING EASIER & AVOID  
THE NEED FOR PLASTIC PLUGS

- MEDIUM TO LIGHT DUTY FIXING
- PREVENTS STRESS IN THE BASE MATERIAL
- ALLOWS FIXINGS NEAR THE EDGE
- PREVENTS DEFORMATION OF THE FRAME
- GREATER LOAD PERFORMANCE THAN MOST NYLON FIXINGS



## IMPACT MASONRY SCREWS

Our own self tapping masonry screws. Higher resistance to fire than nylon fixings.

### CORE USE

- Masonry



### MATERIAL

- Zinc & Yellow Passivated to help prevent corrosion and to increase the overall protection
- White plastic cover caps for a professional, attractive finish



Code	Size (mm)	Drill Hole Dia. (mm)	Max. Fixture Thickness (mm)	Min. Hole Depth (mm)	Box Qty	Outer Qty
MVFMS75040	7.5 x 42	6	-	45	100	1000
MVFMS75050	7.5 x 52	6	10	45	100	1000
MVFMS75060	7.5 x 62	6	20	45	100	1000
MVFMS75070	7.5 x 72	6	30	45	100	1000
MVFMS75080	7.5 x 82	6	40	45	100	1000
MVFMS75090	7.5 x 92	6	50	45	100	1000
MVFMS75100	7.5 x 102	6	60	45	100	1000
MVFMS75110	7.5 x 112	6	70	45	100	1000
MVFMS75120	7.5 x 122	6	80	45	100	800
MVFMS75130	7.5 x 132	6	90	45	100	800
MVFMS75150	7.5 x 152	6	110	45	100	800
MVFMS75180	7.5 x 182	6	140	45	100	600
MVFMS75200	7.5 x 202	6	160	45	100	600
MVFMST30	T30 Screwdriver Bits				20	-

## IMPACT MASONRY INSTALLATION

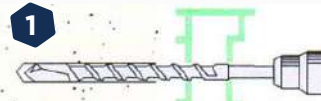

1 Drill at right angles using drill bits of the same diameter ensuring the hole is slightly deeper than the screw and fixture combined

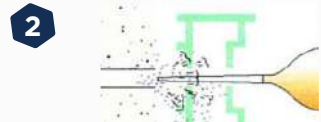

2 Remove any loose dust from the hole

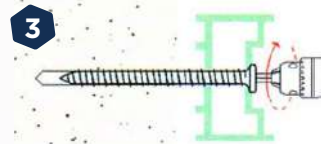

3 Screw in using an appropriate driver and tighten until the fixture is in place

IDEAL FOR USE WITH IMPACT DRIVERS



DRIVER AND CAPS INCLUDED IN EVERY BOX



## LIGHT DUTY MASONRY SCREWS

Medium weight through fixing ideal for installing door and window frames (UPVC, Aluminium or Wood), electrical fittings, wooden battens, radiator brackets, kitchen unit brackets, channel support systems and can even be used with strap/banding material for suspending services.

### CORE USE

- Concrete
- Brick
- Stone



### OTHER APPLICATIONS

- Thin Sheet Metal
- Plastics
- Wood



### MATERIAL

- C1022 carbon steel
- Blue ruspert coating gives 500 hours salt spray corrosion resistance

### HEAD

COUNTERSUNK CROSS HEAD RECESSED FOR A FLUSH FINISH

THREAD  
COARSE, SERRATED THREAD FOR EASIER DRIVING AND A STRONG GRIP



Code	Size (mm)	Drill Hole Dia. (mm)	Max. Fixture Thickness (mm)	Min. Hole Depth (mm)	Box Qty
MTC36032	3/16" x 32	4.3	2	30	100
MTC36045	3/16" x 45	4.3	15	30	100
MTC36057	3/16" x 57	4.3	27	30	100
MTC36070	3/16" x 70	4.3	40	30	100
MTC36082	3/16" x 82	4.3	52	30	100
MTC36100	3/16" x 100	4.3	70	30	100

## EXPRESS NAILS

Used in place of hammer fixings for a speedier installation.

### CORE USE

- Concrete
- Solid brick
- Block
- Stone



- Requires a hole to be drilled then the express nail can just be hammered in



Code	Size (mm)	Drill Hole Dia. (mm)	Box Qty
MEX08090	M8 x 90	8	100
MEX08110	M8 x 110	8	100
MEX08130	M8 x 130	8	100
MEX08150	M8 x 150	8	100
MEX08180	M8 x 180	8	100

## RIMLESS NYLON PLUGS

Rimless nylon plugs can be inserted deeper into the base material.

### CORE USE

- Concrete
- Brick
- Stone



- Ideal for fixing wooden battens, electrical and plumbing fittings, lightweight brackets and shelving



Code	Size (mm)	Drill Hole Dia. (mm)	Min. Hole Depth (mm)	To Suit Screw Gauge (mm)	Box Qty
MNP05	M5 x 25	5	35	2.5-4.0	200
MNP06	M6 x 30	6	40	3.5-5.0	200
MNP08	M8 x 40	8	45	4.5-6.0	100
MNP10	M10 x 50	10	65	6.0-8.0	100
MNP12	M12 x 60	12	75	8.0-10.0	50
MNP14	M14 x 75	14	90	10.0-12.0	50

## METAL CAVITY ANCHORS

Hollow wall cavity fixing, ideal for where fire proofing is required. The expanding legs and the anti-rotation lugs fitted to the anchor head create the anchor hold.

### CORE USE

- Plasterboard
- Fibreboard



- Lightweight cavity fixing suitable for electrical components, trunking, radiator brackets, pipe clips, wooden battens and shelves
- A setting tool makes installation easier - drill, place anchor in tool, place anchor in hole and expand legs using tool, remove screw and then re-fix screw to secure fixture in place



Screw and anchor can also be removed if so desired  
Wall thickness is stated as a minimum/maximum thickness

Code	Size (mm)	Wall Thickness (mm)	Screw Length (mm)	Hole Dia. (mm)	Box Qty
MCA04032	M4 x 32	3/12	32	8	100
MCA04045	M4 x 45	10/16	45	8	100
MCA05045	M5 x 37	8/13	45	10	100
MCA05053	M5 x 53	3/16	53	8	50
MCA05071	M5 x 65	19/32	71	10	50
MCA06045	M6 x 37	6/15	37	12	50

## SELF DRILLING CAVITY FIXINGS

### CORE USE

- Plasterboard



- Lightweight metal cavity fixing for wooden battens, electrical components & curtain track

METAL

NYLON



METAL FIXING SUPPLIED WITH A SCREW

Code	Type	Size (mm)	Washer Dia. (mm)	To Suit Screw (mm)	Box Qty
MSDAM	Metal (incl Screw)	6 x 31	14	4.5 x 38	100
MSDAN	Nylon	5.5 x 24	14	3.5-4.5	100

## SPRING TOGGLES

Designed for where a load spread over a large area is required.

### CORE USE

- Plasterboard
- Fibreboard
- Block

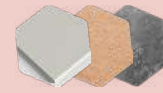

- Ideal for trunking, light fittings, curtain rails, pipe fittings and radiator brackets



Code	Size (mm)	Max. Fixture Thickness (mm)	Cavity Depth (mm)	Hole Dia. (mm)	Box Qty
MST03050	M3 x 50	30	20	11	100
MST05060	M5 x 50	30	34	14	50
MST05080	M5 x 80	50	34	14	50
MST06075	M6 x 75	45	30	18	50

## GRIPIT PLASTERBOARD FIXINGS

A simple method of wall hanging on plasterboard - popular for its ease of use, high performance and convenience.

### CORE USE

- Plasterboard (up to 15mm)



- Four different colours represent each Gripit size which can hold different weights in plasterboard
- Shear max loads between 142-225kg
- Tension max loads of 38-39kg
- Cantilever max loads 23-70kg

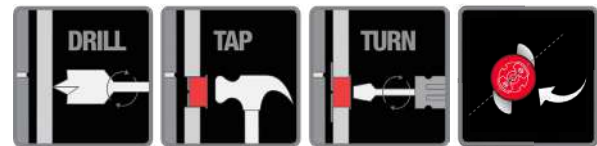

PACKED WITH RECOMMENDED SCREWS - NO NEED FOR ADDITIONAL FIXINGS

### SMALL BAGS

Code	Colour	Size (mm)	Min. Edge Distance (mm)	Bag Qty
MGF15008	Yellow	15	20	8
MGF18008	Red	18	24	8
MGF20008	Brown	20	28	8
MGF25008	Blue	25	28	8

### LARGE BAGS

Code	Colour	Size (mm)	Min. Edge Distance (mm)	Bag Qty
MGF15025	Yellow	15	20	25
MGF18025	Red	18	24	25
MGF20025	Brown	20	28	25
MGF25025	Blue	25	28	25

## TEK SCREW HEX HEAD

Hex head tek screw with a self drilling point for fixing steel.

### CORE USE

- Coarse thread No. 3 for light section steel and fine thread No. 5 for heavy section steel
- No washer tek screws are used for fastening liner panels to steel
- With 16mm EDPM washer are designed for cladding and roofing applications



### NO WASHER

Code	Thread Type	Size (mm)	Point Type	Max. Steel Thickness (mm)	Max. Fixture Thickness (mm)	Box Qty
MTHL4801603	Coarse	4.8 x 16	No. 3	2.8	5	100
MTHL5502503		5.5 x 25	No. 3	3.6	10	100
MTHL5503203		5.5 x 32	No. 3	3.6	17	100
MTHL5503803		5.5 x 38	No. 3	3.6	23	100
MTHL5505003		5.5 x 50	No. 3	3.6	35	100
MTHL5507003		5.5 x 70	No. 3	3.6	55	100
MTHL5510003		5.5 x 100	No. 3	3.6	85	100
MTHH5503205	Fine	5.5 x 32	No. 5	12.0	9	100
MTHH5503805		5.5 x 38	No. 5	12.0	15	100
MTHH5505105		5.5 x 51	No. 5	12.0	28	100
MTHH5506005		5.5 x 60	No. 5	12.0	37	100
MTHH5508005		5.5 x 80	No. 5	12.0	57	100
MTHH5510005		5.5 x 100	No. 5	12.0	77	100

### WITH 16MM EDPM WASHER

Code	Thread Type	Size (mm)	Point Type	Max. Steel Thickness (mm)	Max. Fixture Thickness (mm)	Box Qty
MTHLW550250316	Coarse	5.5 x 25	No. 3	3.6	7	100
MTHLW550320316		5.5 x 32	No. 3	3.6	14	100
MTHLW550380316		5.5 x 38	No. 3	3.6	20	100
MTHLW550510316		5.5 x 51	No. 3	3.6	32	100
MTHLW550700316		5.5 x 70	No. 3	3.6	52	100
MTHLW551000316		5.5 x 100	No. 3	3.6	82	100
MTHHW550250416	Fine	5.5 x 25	No. 5	12.0	2	100
MTHHW550320516		5.5 x 32	No. 5	12.0	6	100
MTHHW550380516		5.5 x 38	No. 5	12.0	12	100
MTHHW550510516		5.5 x 51	No. 5	12.0	25	100
MTHHW550600516		5.5 x 60	No. 5	12.0	34	100
MTHHW550800516		5.5 x 80	No. 5	12.0	54	100
MTHHW551000516	5.5 x 100	No. 5	12.0	74	100	

## TEK SCREW HEX HEAD HIGH-LOW THREAD

Hex head tek screw with a high-low thread for fixing composite panel.

### CORE USE

- Designed specifically for fixing composite panel sheeting to light purlins (1.2-3mm) or timber
- Can also be used for fastening steel wall channelling through insulation to studs
- Panels can be fixed through the valley or the crown of the profile
- The high thread gives positive support to the outer sheet
- The unthreaded piece ensures panel surfaces are not deformed
- The EDPM washer helps compress the outer skin and provides a weatherseal

**THREAD HIGH-LOW COARSE THREAD WITH AN UNTHREADED PIECE**



Code	Thread Type	Size (mm)	Point Type	Max. Steel Thickness (mm)	Max. Fixture Thickness (mm)	Box Qty
MTHLH550760319	Coarse	5.5/6.3 x 85	No. 3	3.6	55	100
MTHLH551000319		5.5/6.3 x 105	No. 3	3.6	85	100

## STITCHING SCREW WITH WASHER

Hex head stitching screw with a self drilling point for fixing sheet steel.

### CORE USE

- Ideal for fixing flashing or cosmetic trim features to insulated wall panels
- Can be used on the lapping rib between purlins if spaced over 600mm apart
- The EDPM washer is fire retardant as well as providing a weatherseal



Code	Thread Type	Size (mm)	Point Type	Max. Fixture Thickness	Box Qty
MTHSW630220116	Coarse	6.3 x 22	No. 1	3 Sheets x 0.7mm	100

## TEK SCREW HEX HEAD SHEET TO TIMBER

Hex head tek screw for fixing sheet to timber.

### CORE USE

- Self drilling screw to fix sheets to timber purlins
- Comes with EDPM washer

**POINT TYPE 17 GASH POINT MAKES THE INITIAL PENETRATION OF THE TIMBER EASIER**



Code	Thread Type	Size (mm)	Point Type	Max. Fixture Thickness (mm)	Box Qty
MTHST6302517	Coarse	6.3 x 25	Type 17	1.4	100
MTHST6303217		6.3 x 32	Type 17	1.4	100
MTHST6305017		6.3 x 45	Type 17	5	100
MTHST6306017		6.3 x 60	Type 17	17	100
MTHST6308017		6.3 x 80	Type 17	37	100
MTHST6310017		6.3 x 100	Type 17	57	100

## TEK SCREW CSK TIMBER TO STEEL

Cross head countersunk self drilling screw for fixing timber to steel.

### CORE USE

- The wings drill a clearance hole in the timber, so the screw can achieve max. performance without burning out
- They also prevent 'jacking' and then snap off as soon as they reach the steel, resulting in a very strong grip

**THREAD SNAP OFF WINGED**



Code	Thread Type	Size (mm)	Point Type	Max. Steel Thickness (mm)	Max. Fixture Thickness (mm)	Box Qty
MTCL5503803	Coarse	5.5 x 38	No. 3	3.6	16	100
MTCL5505003		5.5 x 50	No. 3	3.6	28	100
MTCL5506003		5.5 x 60	No. 3	3.6	43	100
MTCL5508503		5.5 x 85	No. 3	3.6	63	100
MTCL5510003		5.5 x 100	No. 3	3.6	83	100
MTCH5504505	Fine	5.5 x 45	No. 5	12.0	18	100
MTCH5506005		5.5 x 60	No. 5	12.0	33	100
MTCH5508005		5.5 x 80	No. 5	12.0	53	100
MTCH5511005		5.5 x 110	No. 5	12.0	83	100

## BONDED WASHER

### CORE USE

- Provides a weatherseal and fire-retardant

### MATERIAL

- Made from a galvanised washer bonded to EPDM



Code	Size (mm)	Box Qty
MTHW16	16	100
MTHW19	19	100





**LARGE MERCHANT BAGS**  
IN OUTERS OF 1

**SMALL MINI BAGS**  
IN OUTERS OF 5





PROVIDED IN EUROSLOTTED & BARCODED BAGS  
**JOHN GEORGE BRANDED**  
EASILY SALEABLE PACK SIZES  
**AVAILABLE FROM STOCK**



## THUNDERBOLTS

	Size (mm)		
		Outer Qty 1	Outer Qty 5
		MERCHANT BAG Qty M7TH	MINI BAG Qty M8TH
HEX HEAD	M8 x 80	10no	2no
	M8 x 75	10no	2no
	M8 x 100	10no	2no
	M10 x 100	10no	2no
	M10 x 130	10no	2no
	M10 x 150	10no	2no
	M12 x 130	10no	2no
	M12 x 150	5no	2no
M12 x 200	5no	2no	
EYE	M8 x 55	10no	2no
HOOK	M8 x 55	10no	2no







## NUT TYPE SLEEVE ANCHORS

	Size (mm)		
		Outer Qty 1	Outer Qty 5
		MERCHANT BAG Qty M7SA	MINI BAG Qty M8SA
NUT TYPE	M10 x 77	10no	2no
	M10 x 97	10no	2no
	M12 x 75	10no	2no
	M12 x 99	10no	2no
	M12 x 129	10no	2no



## THROUGH BOLTS

	Size (mm)		
		Outer Qty 1	Outer Qty 5
		MERCHANT BAG Qty M7TB	MINI BAG Qty M8TB
NUT TYPE	M10 x 80	10no	2no
	M10 x 100	10no	2no
	M12 x 120	10no	2no
	M12 x 140	10no	2no



## SHIELD ANCHORS

Type	Size (mm)		
		Outer Qty 1	Outer Qty 5
		MERCHANT BAG Qty M7SP/SL/EW/HW	MINI BAG Qty M8SP/SL/EW/HW
PROJECTING BOLT 	M6 x 25	10no	2no
	M6 x 60	10no	2no
	M8 x 10	10no	2no
	M8 x 40	10no	2no
	M8 x 60	10no	2no
	M8 x 80	10no	2no
	M10 x 30	10no	2no
	M10 x 70	10no	2no
	M12 x 30	5no	2no
	M12 x 75	5no	2no
LOOSE BOLT 	M6 x 10	10no	2no
	M8 x 10	10no	2no
	M8 x 25	10no	2no
	M8 x 40	10no	2no
	M10 x 10	10no	2no
	M10 x 25	10no	2no
	M10 x 50	10no	2no
	M10 x 75	10no	2no
M12 x 60	5no	2no	
EYE 	M8 x 60	10no	2no
HOOK 	M8 x 60	10no	2no

## HAMMER FIXINGS



	Size (mm)		
		Outer Qty 1	Outer Qty 5
		MERCHANT BAG Qty M7HF	MINI BAG Qty M8HF
M5 x 30	50no	10no	
M6 x 40	50no	10no	
M6 x 60	50no	10no	
M8 x 80	20no	5no	
M8 x 100	20no	5no	
M8 x 120	20no	5no	

## FRAME FIXINGS



	Size (mm)		
		Outer Qty 1	Outer Qty 5
		MERCHANT BAG Qty M7FF	MINI BAG Qty M8FF
M8 x 60	20no	-	
M8 x 80	20no	5no	
M8 x 100	-	5no	
M10 x 100	20no	5no	
M10 x 115	20no	5no	
M10 x 135	20no	5no	
M10 x 160	10no	5no	





## IMPACT MASONRY SCREWS

		
	Outer Qty 1	Outer Qty 5
	MERCHANT BAG Qty <b>M7VFMS</b>	MINI BAG Qty <b>M8VFMS</b>
7.5 x 82	20no	5no
7.5 x 102	20no	5no
7.5 x 122	20no	5no
7.5 x 152	20no	5no
7.5 x 182	20no	5no



## RIMLESS NYLON PLUGS

		
	Outer Qty 1	Outer Qty 5
	MERCHANT BAG Qty <b>M7NP</b>	MINI BAG Qty <b>M8NP</b>
M10 x 50	20no	5no
M12 x 60	20no	5no



## METAL CAVITY ANCHORS

		
	Outer Qty 1	Outer Qty 5
	MERCHANT BAG Qty <b>M7CA</b>	MINI BAG Qty <b>M8CA</b>
M4 x 45	20no	4no
M5 x 37	20no	4no
M5 x 65	20no	4no







## SELF DRILLING CAVITY FIXINGS

	Size (mm)		
		Outer Qty 1	Outer Qty 5
		MERCHANT BAG Qty <b>M7SDA</b>	MINI BAG Qty <b>M8SDA</b>
Metal Incl Screw	6 x 31	25no	10no
Nylon	5.5 x 24	25no	10no

## SPRING TOGGLES

		
	Outer Qty 1	Outer Qty 5
	MERCHANT BAG Qty <b>M7ST</b>	MINI BAG Qty <b>M8ST</b>
M5 x 50	10no	4no
M5 x 75	10no	4no

## TEK SCREWS

Code	Thread Type	Point Type	Size (mm)	
				Outer Qty 1 MERCHANT BAG Qty
<b>HEX HEAD TEK SCREW WITH 16MM EDPM WASHER</b> 				
M7THLW550250316	Coarse	No. 3	5.5 x 25	25no
M7THLW550320316		No. 3	5.5 x 32	25no
M7THLW550380316		No. 3	5.5 x 38	25no
M7THLW550510316		No. 3	5.5 x 51	25no
M7THHW550250416	Fine	No. 5	5.5 x 25	25no
M7THHW550320516		No. 5	5.5 x 32	25no
M7THHW550380516		No. 5	5.5 x 38	25no
M7THHW550510516		No. 5	5.5 x 51	25no
<b>STITCHING SCREW WITH 16MM EDPM WASHER</b> 				
M7THSW630220116	Coarse	No. 1	6.3 x 22	25no
<b>HEX HEAD SHEET TO TIMBER WITH 16MM EDPM WASHER</b> 				
M7THST6302517	Coarse	Type 17	6.3 x 25	25no
M7THST6303217			6.3 x 32	25no
M7THST6305017			6.3 x 45	25no
<b>CSK HEAD TIMBER TO STEEL</b> 				
M7TCL5505003	Coarse	No. 3	5.5 x 50	25no
M7TCL5506003		No. 3	5.5 x 60	25no
M7TCL5508503		No. 3	5.5 x 85	25no
M7TCL5510003		No. 3	5.5 x 100	25no
M7TCH5504505	Fine	No. 5	5.5 x 45	25no
M7TCH5506005		No. 5	5.5 x 60	25no
M7TCH5508005		No. 5	5.5 x 80	25no
M7TCH5511005		No. 5	5.5 x 110	25no
<b>BONDED WASHER</b> 				
M7THW16	-	-	16	25no
M7THW19	-	-	19	25no

Merchandise our **bagged fixings** alongside our bagged bolts!



Our **Fence Pro** fencing range includes rolls, reels, coils and fence post supports.

All our Fence Pro products are **labelled and barcoded**.

Some of our wire netting and stock fence can be **purchased by the pallet**. Please contact us for details.

Running our own transport allows us to more easily deliver larger fencing items and reduces the likelihood of damage in transit.

# Fence Pro

A comprehensive range of wire fencing products and accessories

## GALVANISED WIRE NETTING

Fence Pro galvanised hexagon wire netting.

### CORE USE

- Used for poultry runs and enclosures, aviary and bird cages, rabbit proofing and general purpose fencing

### MATERIAL

- Manufactured from galvanised wire, then it is hot dip galvanised once again to give double corrosion resistance

**MANUFACTURED TO BS EN 10223-2 1998 REVERSE TWIST SPECIFICATION**



Code	Finish	Mesh (mm)	Gauge (g)	Roll Height (mm)	Roll Length (m)	
WWNG10060013	GALVANISED	13	23	600	10	
WWNG10060025		25	20	600		
WWNG10060050		50	19	600		
WWNG10090013		13	23	900		
WWNG10090025		25	20	900		
WWNG10090050		50	19	900		
WWNG10120013		13	23	1200		
WWNG10120025		25	20	1200		
WWNG10120050		50	19	1200		
WWNG250601323		GALVANISED	13	23	600	25
WWNG250602520			25	20	600	
WWNG250605019			50	19	600	
WWNG250901323			13	23	900	
WWNG250902520			25	20	900	
WWNG250905019			50	19	900	
WWNG251201323			13	23	1200	
WWNG251202520			25	20	1200	
WWNG251205019			50	19	1200	
WWNG251802520	25		20	1800		
WWNG251805019	50		19	1800		
WWNG500601323	GALVANISED		13	23	600	50
WWNG500602520			25	20	600	
WWNG500603119			31	19	600	
WWNG500605019			50	19	600	
WWNG500901323			13	23	900	
WWNG500902520			25	20	900	
WWNG500903119			31	19	900	
WWNG500905019		50	19	900		
WWNG501053118		31	18	1050		
WWNG501053119		31	19	1050		
WWNG501201323		13	23	1200		
WWNG501202520		25	20	1200		
WWNG501203118		31	18	1200		
WWNG501203119		31	19	1200		
WWNG501205019		50	19	1200		
WWNG501801323		13	23	1800		
WWNG501802520		25	20	1800		
WWNG501805019		50	19	1800		

## OPTI-GALV WIRE NETTING

Fence Pro Opti-Galv hexagon wire netting provides a cost effective alternative to our standard galvanised wire netting.

### CORE USE

- Used for poultry runs and enclosures, aviary and bird cages, rabbit proofing and general purpose fencing

### MATERIAL

- Galvanised before manufacture for corrosion resistance

**MANUFACTURED TO BS EN 10223-2 1998 REVERSE TWIST SPECIFICATION**



Code	Finish	Mesh (mm)	Gauge (g)	Roll Height (mm)	Roll Length (m)	
WGNG05060013	OPTI-GALV	13	23	600	5	
WGNG05060025		25	20	600		
WGNG05060050		50	19	600		
WGNG05090013		13	23	900		
WGNG05090025		25	20	900		
WGNG05090050		50	19	900		
WWNOG10060013		OPTI-GALV	13	23	600	10
WWNOG10060025			25	20	600	
WWNOG10060050			50	19	600	
WWNOG10090013			13	23	900	
WWNOG10090025			25	20	900	
WWNOG10090050			50	19	900	
WWNOG10120013			13	23	1200	
WWNOG10120025			25	20	1200	
WWNOG10120050			50	19	1200	
WWNOG500905019			50	19	900	50
WWNOG501053118			31	18	1050	
WWNOG501053119			31	19	1050	
WWNOG501203118	31		18	1200		
WWNOG501203119	31		19	1200		
WWNOG501205019	50		19	1200		

## GREEN PVC COATED WIRE NETTING

Fence Pro green PVC coated hexagon wire netting.

### CORE USE

- Ideal for cages, garden applications, climbing plant support and much more

### MATERIAL

- Green PVC coated for corrosion resistance and a neutral appearance

**MANUFACTURED TO BS EN 10223-2 1998 REVERSE TWIST SPECIFICATION**



Code	Finish	Mesh (mm)	Roll Height (mm)	Roll Length (m)
WGNP1006013	GREEN PVC COATED	13	600	10
WGNP1006025		25	600	
WGNP1006050		50	600	
WGNP1009013		13	900	
WGNP1009025		25	900	
WGNP1009050		50	900	

## WELDED MESH

Fence Pro square/rectangular galvanised mesh.

**MANUFACTURED**  
TO BS EN 10223-4 1998

### CORE USE

- Ideal for using in pet cages or runs

### MATERIAL

- Mesh is welded at every cross-joint making the product very strong and durable as well as being flexible enough to shape
- Galvanised for corrosion resistance



**Fence Pro**

**GREEN PVC 6M ROLLS AVAILABLE IN GARDEN PRODUCTS**

Code	Finish	Reference	Mesh (mm)	Gauge (g)	Roll Height (mm)	Roll Length (m)		
WGWM0609622	GALVANISED	9/6/22	6 x 6	22	900	6		
WGWM060936		9/3/6	13 x 13	16	900			
WGWM060939		9/3/9	13 x 13	19	900			
WGWM0609356		9/3/5/6	13 x 25	16	900			
WGWM0609359		9/3/5/9	13 x 25	19	900			
WGWM060996		9/9/6	19 x 19	16	900			
WGWM060956		9/5/6	25 x 25	16	900			
WGWM060959		9/5/9	25 x 25	19	900			
WGWM060906		9/0/6	50 x 50	16	900			
WGWM061236		12/3/6	13 x 13	16	1200			
WGWM061239		12/3/9	13 x 13	19	1200			
WGWM0612356		12/3/5/6	13 x 25	16	1200			
WGWM0612359		12/3/5/9	13 x 25	19	1200			
WGWM061256		12/5/6	25 x 25	16	1200			
WGWM061259		12/5/9	25 x 25	19	1200			
WGWM061206		12/0/6	50 x 50	16	1200			
WMWG300936		GALVANISED	9/3/6	13 x 13	16		900	30
WMWG300939			9/3/9	13 x 13	19		900	
WMWG3009356			9/3/5/6	13 x 25	16		900	
WMWG3009359			9/3/5/9	13 x 25	19		900	
WMWG300956	9/5/6		25 x 25	16	900			
WMWG300959	9/5/9		25 x 25	19	900			
WMWG300906	9/0/6		50 x 50	16	900			
WMWG301236	12/3/6		13 x 13	16	1200			
WMWG301239	12/3/9		13 x 13	19	1200			
WMWG3012356	12/3/5/6		13 x 25	16	1200			
WMWG3012359	12/3/5/9		13 x 25	19	1200			
WMWG301256	12/5/6		25 x 25	16	1200			
WMWG301259	12/5/9		25 x 25	19	1200			
WMWG301206	12/0/6		50 x 50	16	1200			

## SECURITY FENCING

Heavy duty square welded mesh in 25m rolls. Available either galvanised or green PVC coated.

### CORE USE

- Ideal as a strong barrier fence
- Can be erected using a variety of methods including wooden, concrete or steel posts

### MATERIAL

- Pre-galvanised and welded at every intersection
- More easily erected than chain link



**Fence Pro**

Code	Finish	Mesh (mm)	Core Dia./ Overall Dia. (mm)	Roll Height (mm)	Roll Length (m)
WSFG095025	GALVANISED	50 x 50	2.50	900	25
WSFG095030		50 x 50	3.00	900	
WSFG125025		50 x 50	2.50	1200	
WSFG125030		50 x 50	3.00	1200	
WSFG185025		50 x 50	2.50	1800	
WSFG185030		50 x 50	3.00	1800	
WSFP0950325	GREEN PVC COATED	50 x 50	2.50/3.00	900	25
WSFP1250325		50 x 50	2.50/3.00	1200	
WSFP1850325		50 x 50	2.50/3.00	1800	

## STOCK FENCE

Hinged joint field fencing which is designed to be self draining (crimp draws rain water away from joints) and work with thermal changes.

### CORE USE

- Ideal for both semi-permanent and permanent enclosures
- Flexible, well suited to undulating ground and can be used for livestock or deer

### MATERIAL

- Galvanised coating to BS EN 10244-2:2009
- High tensile steel is up to 3 times stronger

**MANUFACTURED**  
TO BS EN 10223-5



The reference is interpreted as:  
No. of horizontal line wires/roll height/vertical spacing

Code	Finish	Description	Reference	Approx Wire (mm)	No of Horizontal Wires	Vertical Spacing (mm)	Roll Height (mm)	Roll Length (m)
WSTGC69030	GALV	Medium Stock Fence	C6/90/30	2.5-3.0	6	300	900	50
WSTGC81130			C8/11/30	2.5-3.0	8	300	1145	50
WSTGC88015			C8/80/15	2.5-3.0	8	150	800	50
WSTGHT88015		High Tensile	HT8/80/15	2.5	8	150	800	100
WSTGL88015		Light Stock Fence	L8/80/15	1.9-2.5	8	150	800	50
WSTGL101215			L10/120/15	1.9-2.5	10	150	1180	50
WSTGL2320015		Deer Fence	L23/200/15	1.9-2.5	23	150	2000	50

## CHAIN LINK FENCING

Diamond pattern industry standard chain link fencing provided in tight wound rolls. Line wire included with each roll.

### CORE USE

- Typically used for marking out boundaries and is assembled and strained on site
- Use with steel or concrete posts

### MATERIAL

- Galvanised or PVC coated which has a galvanised core to increase longevity

**MANUFACTURED**  
TO BS EN 10223-4 1998 AND  
COATED TO BS EN 10244-1/2



**Fence Pro**

**GALVANISED & GREEN PVC COATED 10M ROLLS AVAILABLE IN GARDEN PRODUCTS**

Code	Finish	Mesh (mm)	Core Dia./ Overall Dia. (mm)	Roll Height (mm)	Roll Length (m)	
WCLGU122509	GALVANISED	50	2.50	900	12.5	
WCLGU122512		50	2.50	1200		
WCLGU123018		50	3.00	1800		
WCLGU123024		50	3.00	2400		
WCLGU252509		GALVANISED	50	2.50	900	25
WCLGU252512			50	2.50	1200	
WCLGU252514			50	2.50	1400	
WCLGU252518			50	2.50	1800	
WCLGU253009			50	3.00	900	
WCLGU253012			50	3.00	1200	
WCLGU253014			50	3.00	1400	
WCLGU253015			50	3.00	1500	
WCLPU122509		GREEN PVC COATED	50	1.70/2.50	900	12.5
WCLPU122512			50	1.70/2.50	1200	
WCLPU122518	50		1.70/2.50	1800		
WCLPU123124	50		2.24/3.15	2400		
WCLPU123127	50		2.24/3.15	2750		
WCLPU252509	GREEN PVC COATED		50	1.70/2.50	900	25
WCLPU252512			50	1.70/2.50	1200	
WCLPU252514			50	1.70/2.50	1400	
WCLPU252518			50	1.70/2.50	1800	
WCLPU253109			50	2.24/3.15	900	
WCLPU253112		50	2.24/3.15	1200		
WCLPU253114		50	2.24/3.15	1400		
WCLPU253115		50	2.24/3.15	1500		
WCLPU253118	50	2.24/3.15	1800			
WCLPUB253109	BLACK PVC COATED	50	2.24/3.15	900	25	
WCLPUB253112		50	2.24/3.15	1200		
WCLPUB253118		50	2.24/3.15	1800		



## WELDED MESH PANELS

### CORE USE

- Highly versatile, ideal for the garden, allotments and construction sites
- Used in security fencing, animal fencing, climbing plant support and fruit cages

### MATERIAL

- Made from galvanised steel wire for long-lasting, corrosion resistant performance

MANUFACTURED TO BS EN 10223-4 1998

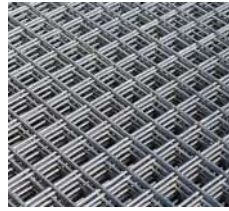

Code	Finish	Mesh	Gauge (g)	Panel Size
WMWPG06031112	GALVANISED	1" x 1"	12	6' x 3'
WMWPG06032210		2" x 2"	10	
WMWPG06033306		3" x 3"	6	
WMWPG06033606		3" x 6"	6	
WMWPG08041112	GALVANISED	1" x 1"	12	8' x 4'
WMWPG08042210		2" x 2"	10	
WMWPG08042212		2" x 2"	12	
WMWPG08043310		3" x 3"	10	

## HANDY MESH PANELS

### CORE USE

- Ideal for pet cages, greenhouse staging, window guards, plant support or as a supporting grid for fountains

### MATERIAL

- Manufactured from medium tensile galvanised steel wire

EASY TO INSTALL

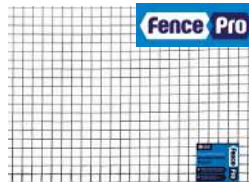

Code	Finish	Size (mm)	Mesh (mm)	Pack Qty
WGHP0606	GALVANISED	910 x 610	6 x 6	10
WGHP1313		910 x 610	13 x 13	10
WGHP1325		910 x 610	13 x 25	10
WGHP2525		910 x 610	25 x 25	10
WGHPG2525	GREEN PVC COATED	910 x 610	25 x 25	10
WGHPG5050		910 x 610	50 x 50	10

## BARBED WIRE

### CORE USE

- Provides additional security when used with other fencing
- Most commonly used as the topline on an agricultural fence

### MATERIAL

- Galvanised, 4 point barbed wire

MANUFACTURED TO BS EN 10223-1 1998



Code	Finish	Type	Line Wire Diameter (mm)	Barb Wire Diameter (mm)	Barb Spacing (mm)	Length (m)
WBWGMS	GALVANISED	Mild Steel	2.50	2.00	75	200
WGBW015		Mild Steel	2.50	2.00	75	15
WBWGHT		High Tensile	1.60	1.60	75	200

## RAZOR WIRE (BARBED TAPE)

### CORE USE

- Alternative to Barbed Wire
- Used to top off a security fence in conjunction with bent over arms
- The clipped concertina reel forms a cylinder when installed

ANTI-INTRUDER FISH TAIL BARBS



Code	Finish	Type	Coil Dia. (mm)	Reel/Concertina Length (m)
WBWRG200MN	GALVANISED	Medium Unclipped	-	200
WBWRG045MC		Medium Concertina	450	8-10

## GALVANISED WIRE

### CORE USE

- Mild Steel is ideal for general fencing
- High Tensile Steel (Grade 8.8) is used for more specialised fencing work where extra strength is required
- The ½ kg coils in the thinner gauges are useful for jobs around the garden



Code	Finish	Type	Size (mm)	Coil Length (m)	Coil Weight (kg)
WWWG005071	GALVANISED	Mild Steel	0.71	165	½
WWWG005090		Mild Steel	0.90	103	
WWWG005100		Mild Steel	1.00	84	
WWWG005125		Mild Steel	1.25	52	
WWWG005160		Mild Steel	1.60	32	
WWWG005200		Mild Steel	2.00	20	
WWWG005250		Mild Steel	2.50	13	5
WWWG050125		Mild Steel	1.25	519	
WWWG050160		Mild Steel	1.60	317	
WWWG050200		Mild Steel	2.00	203	
WWWG050250	Mild Steel	2.50	130		
WWWG050315	Mild Steel	3.15	82		
WWWG050400	Mild Steel	4.00	51	10	
WWWG100160	Mild Steel	1.60	634		
WWWG100200	Mild Steel	2.00	406		
WWWG100250	Mild Steel	2.50	260		
WWWG100315	Mild Steel	3.15	164		
WWWG100400	Mild Steel	4.00	102		25
WWWG25160	Mild Steel	1.60	1585		
WWWG25200	Mild Steel	2.00	1015		
WWWG25250	Mild Steel	2.50	649		
WWWG25315	Mild Steel	3.15	409		
WWWG25400	Mild Steel	4.00	254	25	
WWWGHT250	High Tensile	2.50	649		
WWWGHT315	High Tensile	3.15	409		

## STRAND WIRE

### CORE USE

- 3mm strand wire twisted for strength
- 40kgs max. load



Code	Finish	Size (mm)	Coil Length (m)	Coil Weight (kg)
WWSG3025	BZP	3.00	30	1.63

## LINE WIRE & TYING WIRE

### CORE USE

- Line wire is for use with chain link fencing where additional line wire is required or to replace damaged line wire in existing fences
- Tying wire is for tying chain link fencing to line wire and for fastening climbing plants to walls



Code	Finish	Type	Core Dia. / Overall Dia. (mm)	Coil Length (m)	Coil Weight (kg)
WWLG025300	GALVANISED	Line Wire	3.00	25	1.40
WWLG025355		Line Wire	3.55	25	1.80
WWLG050300		Line Wire	3.00	50	2.80
WWLP025315	GREEN PVC COATED	Line Wire	2.24/3.15	25	0.90
WWLP025355		Line Wire	2.50/3.55	25	1.14
WWLP050315		Line Wire	2.24/3.15	50	1.80
WWLP075315		Line Wire	2.24/3.15	75	2.70
WWLPG25335	GREEN PVC COATED	Line Wire	2.50/3.55	550	25.0
WWLP020		Tying Wire	1.40/2.00	34	0.50
WWLP020B	BLACK PVC COATED	Tying Wire	1.40/2.00	34	0.50



### FENCE POST SUPPORT

#### CORE USE

- Makes the erection of timber fence posts easier and quicker
- Single corner tightening action helps with speedy installation and gives full adjustability

#### MATERIAL

- Standard brown supports are powder coated over steel to aid corrosion resistance and give a neutral look
- Galvanised finish for improved corrosion resistance

FLAT SOCKET BASE HELPS THE DRIVING IN OF THE SUPPORT

FOUR FINES FOR EXTRA STRENGTH WHEN DRIVING IN



Code	Finish	Post Size (mm)	Spike Length (mm)	Overall Length (mm)	Box Qty
WFSP020218	BROWN	50 x 50	450	600	8
WFSP030324		75 x 75	600	750	8
WFSP030330		75 x 75	750	900	8
WFSP040430		100 x 100	750	900	8
WFSPG030324	GALVANISED	75 x 75	600	750	8
WFSPG040430		100 x 100	750	900	8

### CONCRETE IN SUPPORT

#### CORE USE

- Used to secure fence posts in hard standing areas where ground preparation is possible

#### MATERIAL

- Standard brown supports are powder coated over steel to aid corrosion resistance and give a neutral look
- Galvanised finish for improved corrosion resistance

#### INSTALLATION

- Need to ensure the concrete is at least 450mm across and check alignment regularly during the installation process

SINGLE CORNER TIGHTENING FOR SPEEDY INSTALLATION BUT WITH FULL ADJUSTABILITY



Code	Finish	Post Size (mm)	Socket Height (mm)	Overall Length (mm)	Pack Qty
WFCI0303	BROWN	75 x 75	150	310	10
WFCI0404		100 x 100	150	310	10
WFCIG0303	GALVANISED	75 x 75	150	310	10
WFCIG0404		100 x 100	150	310	10

### BOLT DOWN POST SUPPORT

#### CORE USE

- For flat, concrete or wooden surfaces
- Can also be used on decking for balustrades
- Suitable for a wide range of garden and outdoor structures
- Flush fit versions are suitable for flat, narrow or wooden surfaces where a flush fit is required

#### MATERIAL

- Standard brown supports are powder coated over steel to aid corrosion resistance and give a neutral look
- Galvanised finish for improved corrosion resistance

HEAVY DUTY TWIN BOLT GRIP ALLOWS EASY INSTALLATION OR REPLACEMENT OF POSTS



Code	Finish	Type	Post Size (mm)	Socket Height (mm)	Box Qty
WFAPO202	BROWN	Standard	50 x 50	150	10
WFAPO303		Standard	75 x 75	150	10
WFAPO404		Standard	100 x 100	150	10
WFAPO606		Standard	150 x 150	170	5
WFAPF0303		Flush Fit	75 x 75	150	10
WFAPF0404		Flush Fit	100 x 100	150	10
WFAPG0303	GALVANISED	Standard	75 x 75	150	10
WFAPG0404		Standard	100 x 100	150	10
WFAPG0606		Standard	150 x 150	170	5
WFAPFG0303		Flush Fit	75 x 75	150	10
WFAPFG0404	Flush Fit	100 x 100	150	10	

### FENCE POST DRIVING TOOL

#### CORE USE

- Avoids damaging fence post support socket when driving into ground
- Provides a useful aid to the alignment of the post itself

HANDLES ALLOW THE TOOL TO BE HELD & REALIGNED



Code	Size (mm)	Overall Length (mm)	Pack Qty
WFDT001	70 x 70	180	1

### FENCE POST EXTENDER

#### CORE USE

- Used to extend an existing post - either to add trellis or for an additional fencing panel

#### INSTALLATION

- Remove any existing post caps and use a driving tool to install the extender onto the existing post, then drive a new post section into the top of the extender

CAN BE PAINTED TO COMPLEMENT EXISTING FENCING



Code	Finish	Post Size (mm)	Overall Length (mm)	Pack Qty
WFPE0303	BROWN	75 x 75	180	10
WFPE0404		100 x 100	180	10
WFPEG0303	GALVANISED	75 x 75	180	10
WFPEG0404		100 x 100	180	10

### FENCE POST REPAIR SUPPORT

#### CORE USE

- Used to repair a fence post that has been damaged, rotted or broken off near ground level

#### MATERIAL

- Standard brown supports are powder coated over steel to aid corrosion resistance and give a neutral look
- Galvanised finish for improved corrosion resistance

SINGLE CORNER TIGHTENING FOR SPEEDY INSTALLATION BUT WITH FULL ADJUSTABILITY



Code	Finish	Post Size (mm)	Socket Height (mm)	Overall Length (mm)	Box Qty
WFRA0303	BROWN	75 x 75	150	400	10
WFRA0404		100 x 100	150	400	10
WFRAG0303	GALVANISED	75 x 75	150	400	10
WFRAG0404		100 x 100	150	400	10

### HANDRAIL CONNECTOR

#### CORE USE

- Used for connecting a handrail to a deck post
- Ensures the top of the handrail is free from fixings

#### INSTALLATION

- Fix the connector to the handrail first, then attach the vertical side of the connector to the deck post



Code	Finish	Size (mm)	Pack Qty
WHC303525	BZP	30 x 35 x 25	10

## BARRIER FENCE

### CORE USE

- Ideal for many temporary fencing applications in construction, around the garden or at events for crowd control
- Use together with lamp hook fencing pins

### MATERIAL

- Highly visible, plastic barrier mesh made from recycled materials



Code	Finish	Type	Roll Height (m)	Roll Length (m)	Pack Qty
WBFZO501	ORANGE PVC	Light Duty	1	50	1
WBF0501		Medium Duty	1	50	1
WBFB501	BLUE PVC	Medium Duty	1	50	1
WBFC501	GREEN PVC	Medium Duty	1	50	1
WBFY501	YELLOW PVC	Medium Duty	1	50	1

## FENCING PINS

### CORE USE

- Designed for use with plastic barrier fencing

### MATERIAL

- Quality steel pins which can be reused multiple times

**LAMP HOOK**  
FOR EASY FASTENING  
TO THE TOP OF THE  
BARRIER FENCING



FOR BARRIER TAPE SEE OUR SEALANTS SECTION

Code	Finish	Length (m)	Approx. Dia. (mm)	Pack Qty
WFPIN	SELF COLOUR	1.25	10mm	10

When installing as a **temporary barrier**, we recommend using **1 fencing pin every 5 metres**.

For a **longer lasting barrier**, use **1 fencing pin every 3 metres**.

## PALLETISED FENCING

We can provide key sizes of **Wire Netting and Chain Link Fencing** either delivered to you or direct from the manufacturer.

Please contact us:



**JOHN GEORGE**  
**0118 941 1234**



**HENRY SHAW**  
**0121 772 5561**



### ARRIS RAIL REPAIR BRACKETS

#### CORE USE

- Used on arris rails in close board fences
- Can be used to repair broken rails
- Can save time cutting tongues and slots if used when constructing a new fence

#### MORTICE TYPE REPAIR BRACKETS:

Used for fixing directly into morticed concrete posts.

#### BOLT ON REPAIR BRACKETS:

Used to attach arris rails to timber or concrete posts. They are smaller, less obtrusive and easier to fix than standard brackets.



STANDARD



MORTICE TYPE



BOLT ON

Code	Finish	Type	Pack Qty
WARB012	EPOXY BROWN	Standard	25
WARG0125	GALVANISED	Standard	10
WARMA		Mortice	1
WARGBL		Bolt On - Left Hand	50
WARGBR		Bolt On - Right Hand	50

### PANEL SECURITY BRACKET

#### CORE USE

- Designed to secure fence panels around 4" concrete posts
- Helps to prevent unwanted removal or theft



Code	Finish	Size	Pack Qty
WPSBZ100	GALVANISED	For 4" concrete posts	50

### KNEE RAIL STRAP

#### CORE USE

- Used for securing the top rail of a knee rail fence to the upright post

PRE-HOLED FOR EASE OF FIXING



#### MATERIAL

- Galvanised for corrosion resistance

Code	Finish	Type	Size	Pack Qty
WKRG3018	GALVANISED	Bent	For 3" posts	25
WKRG3018F		Flat	For 3" posts	25
WKRG4000		Bent	For 4" posts	25

### CANT RAIL BRACKET

#### CORE USE

- For use with cant rails
- Can be used when erecting close board fences or for repair work



Code	Finish	Type	Pack Qty
WARCBG	GALVANISED	Standard	50

### GRAVEL BOARD CLEAT

#### CORE USE

- Designed to attach gravel boards to concrete posts
- Three holes give maximum adjustment when fixing the gravel board

300MM



#### MATERIAL

- Galvanised for corrosion resistance



We now stock a **Gravel Board Cleat Set** complete with all bolts and fixings available in our **GatePro Prepacked Ironmongery section**

Code	Finish	Size (mm)	Size (Inch)	Pack Qty
WGBC06	GALVANISED	150	6"	1
WGBC12		300	12"	1

### PANEL CLIP | U-TYPE

#### CORE USE

- For easy attachment of wooden fence panels to wooden fence posts
- Makes it easier to remove/replace fence panels in the future



Code	Finish	Size (mm)	Pack Qty
WPCZ044	ZINC PLATED	44	100
WPCZ050		50	100

### TRELLIS CLIPS

#### CORE USE

- Alternative to U-type clips
- Used to fix fence or trellis panels to timber posts
- Use 4 clips per side of panel



Code	Finish	Size (mm)	Pack Qty
WPTCZ060	GALVANISED	60	100

### GRAVEL BOARD BRACKET

#### CORE USE

- Used to fit fence base boards to wooden posts
- 25mm ideal for wooden boards as no upper lip for complete adjustment
- 50mm used for concrete boards as the bottom lip supports the board

50MM

25MM

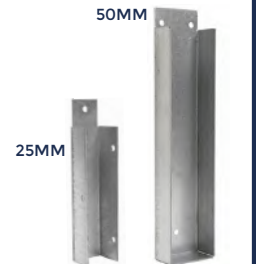

#### MATERIAL

- Galvanised for corrosion resistance

Code	Finish	Size (mm)	Pack Qty
WGBB15025	GALVANISED	150 x 25	1
WGBB15050		150 x 50	1
WGBB20025		200 x 25	1
WGBB22550		225 x 50	1

## GRIPPLE PLUS WIRE JOINERS

Gripple wire joiners for joining and tensioning wire. The name derives from the fact the device both grips and pulls the wire.

### CORE USE

- A quick, easy and effective method of joining two wires together
- Can be used on plain or barbed wire, field and livestock fencing
- Has a positional setting which allows it to be brought back if pushed on too far

### MATERIAL

- Zinc & Aluminium for high corrosion resistance

**FOR WIRE SIZE**  
2.00-3.25 MM

**MAX. WORKING LOAD**  
400 KG

**EASILY RE-TENSIONED**  
YEAR AFTER YEAR



**TOOL DEAL COMES WITH**  
1 X TORQUE TOOL  
250 X GRIPPLE PLUS MEDIUM

Code	Description	Finish	For Wire Size (mm)	Pack Qty
WGRIIP	Gripple Plus Medium	ZINC ALUMINIUM	2.00-3.25	20
WGRIIPK	Torque Tool + 250 Medium Gripples		2.00-3.25	1 Tool+250 Gripples

## HOG RINGS & PLIERS

D-type hog rings made from galvanised steel to provide a long lasting secure fastening. Provided in euroslotted hanging clam.

### CORE USE

- Ideal for fastening chain link, installing wire fences, mesh or netting

### MATERIAL

- Hog rings are galvanised for high corrosion resistance

**USE WITH CT22 CLIPTOOL PLIERS**

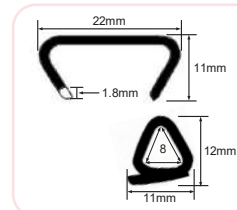

**CT22 PLIERS**  
MADE FROM STAINLESS STEEL FOR DURABILITY



Code	Description	Finish	Pack Qty
WHRZCL221000	CL22 Hog Rings	GALVANISED	1000
WHRPRP22A	CT22 Cliptool Pliers	STAINLESS STEEL	1

## NETTING CLIPS

Our own Fence Pro netting clips provided in euroslotted hanging clams. To fit FP222 Rapid Fencing Pliers.

### CORE USE

- Heavy duty netting clips that are ideal for thicker wire netting and chain link to fence wires
- Can be used for both domestic and professional requirements

**USE WITH FP222 RAPID FENCING PLIERS**

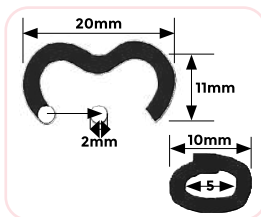

**Fence Pro**



Code	Finish	Pack Qty
WHZCCZ1000	GALVANISED	1000
WHZCCG1000	GREEN PVC	1000

## CL35 NETTING CLIPS

### CORE USE

- High quality clips for a wide variety of applications when connecting multiple pieces of wire, cable or rope together
- Designed to work in all major manufacturers clip tools available on the market

### MATERIAL

- Stainless steel for ultimate corrosion resistance and outdoor use

**USE WITH CL35 CLIP PLIERS (NOT STOCKED)**



Code	Description	Finish	Pack Qty
WHRSSCL35	CL35 Netting Clips	STAINLESS STEEL	1224

## FP222 RAPID FENCING PLIERS

### CORE USE

- Used for more demanding tasks such as fixing thicker wire netting or chainlink fencing
- A high capacity heavy-duty ring magazine for 50 clips
- Load indicator advises you how many clips are left in the pliers

**ERGONOMIC SOFT HANDLE & HANDLE LOCK**  
FOR EASY STORAGE,  
OPTIMIZED PERFORMANCE & COMFORT

**QUICK & EASY TO LOAD**



Code	Description	Pack Qty
WHZFP222	FP222 Rapid Fencing Pliers	1

## NETTING FASTENERS & PLIERS

### CORE USE

- Used to attach chain link fencing and wire netting to straining wire
- Cost effective solution

### MATERIAL

- A choice of bright zinc plated or sherardised clips

**USE WITH WNF001 NETTING PLIERS**

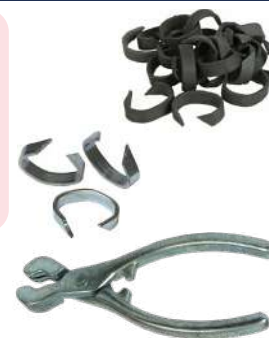

Code	Description	Finish	Pack Qty
WNFZ001	Wire Netting Fasteners	BZP	500
WNFS001	Wire Netting Fasteners	SHERARDISED	500
WNFP001	Pliers for Wire Netting Fasteners	-	1



## CORNER STRAINING FENCE POST

External corner straining post designed for line wires and ideal for use with chain link fencing.

**STANDARD DUTY**  
Black finish only  
40 x 40 x 5 mm

**HEAVY DUTY**  
Black or galvanised  
50 x 50 x 6 mm

**COMPLETE WITH**

- 2 x struts
- 2 x stretcher bars
- Winders for the line wires



Code	Finish	Type	Size (m)	For Fence Height (mm)	Pack Qty
WFPC51540	BLACK FINISH	Standard Duty	1.5	900	1
WFPC51840		Standard Duty	1.8	1200	1
WFPC52040		Standard Duty	2.0	1400	1
WFPC52140		Standard Duty	2.1	1500	1
WFPC52440		Standard Duty	2.4	1800	1
WFPC61550		Heavy Duty	1.5	900	1
WFPC61850		Heavy Duty	1.8	1200	1
WFPC62450		Heavy Duty	2.4	1800	1
WFPCG61550	GALVANISED	Heavy Duty	1.5	900	1
WFPCG61850		Heavy Duty	1.8	1200	1
WFPCG62450		Heavy Duty	2.4	1800	1

## END STRAINING FENCE POST

End straining post designed for line wires and ideal for use with chain link fencing.

**STANDARD DUTY**  
Black finish only  
40 x 40 x 5 mm

**HEAVY DUTY**  
Black or galvanised  
50 x 50 x 6 mm

**COMPLETE WITH**

- 1 x strut
- 1 x stretcher bars
- Winders for the line wires



Code	Finish	Type	Size (m)	For Fence Height (mm)	Pack Qty
WFPE51540	BLACK	Standard Duty	1.5	900	1
WFPE51840		Standard Duty	1.8	1200	1
WFPE52040		Standard Duty	2.0	1400	1
WFPE52140		Standard Duty	2.1	1500	1
WFPE52440		Standard Duty	2.4	1800	1
WFPE61550		Heavy Duty	1.5	900	1
WFPE61850		Heavy Duty	1.8	1200	1
WFPE62450		Heavy Duty	2.4	1800	1
WFPEG61550	GALVANISED	Heavy Duty	1.5	900	1
WFPEG61850		Heavy Duty	1.8	1200	1
WFPEG62450		Heavy Duty	2.4	1800	1

## 2 WAY STRAINING FENCE POST

A 2 way straining post for a straight run. Designed for line wires and ideal for use with chain link fencing.

**STANDARD DUTY**  
Black finish only  
40 x 40 x 5 mm

**HEAVY DUTY**  
Black or galvanised  
50 x 50 x 6 mm

**COMPLETE WITH**

- 2 x struts
- 2 x stretcher bars
- Winders for the line wires



Code	Finish	Type	Size (m)	For Fence Height (mm)	Pack Qty
WFPS51540	BLACK	Standard Duty	1.5	900	1
WFPS51840		Standard Duty	1.8	1200	1
WFPS52040		Standard Duty	2.0	1400	1
WFPS52140		Standard Duty	2.1	1500	1
WFPS52440		Standard Duty	2.4	1800	1
WFPS61550		Heavy Duty	1.5	900	1
WFPS61850		Heavy Duty	1.8	1200	1
WFPS62450		Heavy Duty	2.4	1800	1
WFPSG61550	GALVANISED	Heavy Duty	1.5	900	1
WFPSG61850		Heavy Duty	1.8	1200	1
WFPSG62450		Heavy Duty	2.4	1800	1

## ANGLE IRON STAKES

Also known as Intermediate Standards. Pre-drilled for line wires.

**STANDARD DUTY**  
Black finish only  
40 x 40 x 3mm

1.4 TO 1.6 HAS 2 HOLES  
1.8 TO 2.4 HAS 3 HOLES

**HEAVY DUTY**  
Black or galvanised  
40 x 40 x 5mm



Code	Finish	Type	Size (m)	For Fence Height (mm)	Pack Qty
WFPA31440	BLACK	Standard Duty	1.4	900	1
WFPA31640		Standard Duty	1.6	1050	1
WFPA31840		Standard Duty	1.8	1200	1
WFPA32040		Standard Duty	2.0	1400	1
WFPA32140		Standard Duty	2.1	1500	1
WFPA32440		Standard Duty	2.4	1800	1
WFPA51540		Heavy Duty	1.5	900	1
WFPA51850		Heavy Duty	1.8	1200	1
WFPA52440		Heavy Duty	2.4	1800	1
WFPAG51540		GALVANISED	Heavy Duty	1.5	900
WFPAG51850	Heavy Duty		1.8	1200	1
WFPAG52440	Heavy Duty		2.4	1800	1

## BENT OVER ARMS

### CORE USE

- Can be bolted to fence uprights, walls or other surfaces in order to extend a fence

**FLAT**  
FOR BOLTING TO  
FENCE UPRIGHTS



### MATERIAL

- Black coated steel

**ANGLE**  
FOR BOLTING TO WALLS  
OR OTHER SURFACES

Code	Finish	Type	Size (mm)	Pack Qty
WFBF001	BLACK	Flat	700x30x6	1
WFBAA001		Angle	700x40x40x5	1

## BARBED WIRE ANGLE BRACKET

### CORE USE

- For use with barbed wire or razor wire

2 x PRE-DRILLED HOLES  
10MM  
3 x SLITS  
FOR WIRE



### MATERIAL

- Heavy duty galvanised steel for corrosion resistance

Code	Finish	Bottom Arm	Top Arm	Pack Qty
WFBW015016	GALVANISED	15"	16"	1

## STRETCHER BAR

### CORE USE

- Use with chain link fencing with concrete posts

### MATERIAL

- Galvanised steel for high corrosion resistance



Code	Finish	To Suit Fence (mm)	Pack Qty
WSBG0950	GALVANISED	900	1
WSBG1250		1200	1
WSBG1450		1400	1
WSBG1500		1500	1
WSBG1850		1800	1
WSBG2400		2400	1
WSBG2750		2700	1

## ANGLE CLEAT

### CORE USE

- Adjustable bracket mostly used for attaching stretcher bars to fence posts but also used for connecting posts and railings

CAN PROVIDE BOTH HORIZONTAL & VERTICAL ADJUSTMENT



### MATERIAL

- Galvanised for corrosion resistance

Code	Finish	Size (mm)	Thickness (mm)	Pack Qty
WACG150	GALVANISED	38 x 38	5	1
WACG200		50 x 50	6	1

## LOOP ADAPTER

Also known as "eye loop".

### CORE USE

- Used on concrete and timber posts
- To convert single headed eye bolts into double headed eye bolts
- Used in conjunction with an eye bolt when tensioning line wires from a strainer post



### MATERIAL

- Galvanised for corrosion resistance

Code	Finish	Size (inch)	Size (mm)	Pack Qty
WLAG375	GALVANISED	3/8"	10	10

## RATCHET WINDER

### CORE USE

- Tightens line wire to the required tension
- Often used with chain link fencing line wire
- Bolted to either concrete or timber posts



### MATERIAL

- Galvanised for corrosion resistance

Code	Finish	Pack Qty
WWSGA01	GALVANISED	1

## WIRE STRAINER

Also known as "ferrule winder" or "locking strainer".

### CORE USE

- Used with steel chain link fencing posts to tension the line wire and keep it strong and tight between the metal posts



### MATERIAL

- Galvanised for corrosion resistance

Code	Finish	Type	Size (inch)	Pack Qty
WWSGB01	GALVANISED	Locking	3 1/2"	1

## BARREL STRAINER

Also known as "turnbuckle" or "straining screw".

### CORE USE

- A fixing tool that helps to adjust the tension in wire rope assemblies when creating a netting frame



Code	Finish	Dimensions (mm)	Pack Qty
WBSG06110	BZP	6 x 85	1
WBSG08110		8 x 110	1
WBSG10112		10 x 130	1

## STRAINING EYE BOLTS

### CORE USE

- Used for straining and tightening wires
- Can also be used to secure cable or rope
- Can be easily adjusted

**WELDED**  
ALL COME WITH  
2 x NUTS  
2 x WASHERS

**FOLDED**  
6-8MM COME WITH  
1 x NUT  
1 x WASHER



**THREADED SHAFT**  
PROVIDES A SECURE FITTING  
ONCE INSTALLED

Code	Finish	Head Pattern	No. of Nuts & Washers	Size (inch)	Size (mm)	Pack Qty	
WEBFZ06150	BZP	Folded	1	1/4" x 6"	6 x 150	20	
WEBFZ08150		Folded	1	3/16" x 6"	8 x 150	20	
WEBFZ08200		Folded	1	5/16" x 8"	8 x 200	20	
WEBFZ08250		Folded	1	3/8" x 10"	8 x 250	20	
WEBFZ10150		Folded	2	3/8" x 6"	10 x 150	20	
WEBFZ10200		Folded	2	3/8" x 8"	10 x 200	20	
WEBFZ10250		Folded	2	3/8" x 10"	10 x 250	20	
WEBFZ10300		Folded	2	3/8" x 12"	10 x 300	20	
WEBWZ10150		GALVANISED	Welded	2	3/8" x 6"	10 x 150	10
WEBWZ10200			Welded	2	3/8" x 8"	10 x 200	10
WEBWZ10250			Welded	2	3/8" x 10"	10 x 250	10
WEBWZ10300			Welded	2	3/8" x 12"	10 x 300	10
WEBWG10150			Welded	2	3/8" x 6"	10 x 150	10
WEBWG10200			Welded	2	3/8" x 8"	10 x 200	10
WEBWG10250			Welded	2	3/8" x 10"	10 x 250	10
WEBWG10300	Welded		2	3/8" x 12"	10 x 300	10	

## OPTI-GALV WIRE NETTING

### CORE USE

- Used for poultry runs and enclosures, aviary and bird cages, rabbit proofing and general purpose fencing

**MANUFACTURED**  
TO BS EN 10223-2 1998  
REVERSE TWIST  
SPECIFICATION



### MATERIAL

- Galvanised before manufacture for corrosion resistance
- Cost effective alternative to standard galvanised netting

Code	Finish	Mesh (mm)	Gauge (g)	Roll Height (mm)	Roll Length (m)
WGNG05060013	OPTI-GALV	13	23	600	5
WGNG05060025		25	20	600	
WGNG05060050		50	19	600	
WGNG05090013		13	23	900	
WGNG05090025		25	20	900	
WGNG05090050		50	19	900	

## GREEN PVC COATED WIRE NETTING

### CORE USE

- Ideal for cages, garden applications, climbing plant support and much more

**MANUFACTURED**  
TO BS EN 10223-2 1998  
REVERSE TWIST  
SPECIFICATION



### MATERIAL

- Green PVC coated for corrosion resistance and a neutral appearance

Code	Finish	Mesh (mm)	Roll Height (mm)	Roll Length (m)
WGPN1006013	GREEN PVC COATED	13	600	10
WGPN1006025		25	600	
WGPN1006050		50	600	
WGPN1009013		13	900	
WGPN1009025		25	900	
WGPN1009050		50	900	

### GREEN PVC COATED WELDED MESH

**GALVANISED 6M & 30M MESH**  
AVAILABLE IN WIRE FENCING - ROLLS

MANUFACTURED  
TO BS EN 10223-4 1998

**CORE USE**

- Ideal for pet cages or runs

**MATERIAL**

- Green PVC coated electro-galvanised core to increase longevity and to provide a neutral look



Fence Pro

Code	Finish	Mesh (mm)	Gauge (g)	Roll Height (mm)	Roll Length (m)
WGWP06933N	GREEN PVC COATED	13 x 13	20/23	900	6
WGWP069520N		25 x 25	15/17	900	
WGWP06904N		50 x 50	12/14	900	

### HANDY MESH PANELS

**CORE USE**

- Ideal for pet cages, greenhouse staging, window guards, plant support or as a supporting grid for fountains

**MATERIAL**

- Manufactured from medium tensile galvanised steel wire

EASY TO INSTALL

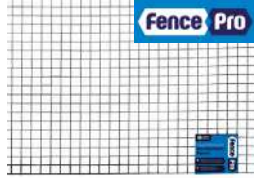

Fence Pro

Code	Finish	Size (mm)	Mesh (mm)	Pack Qty
WGHP0606	GALVANISED	910 x 610	6 x 6	10
WGHP1313		910 x 610	13 x 13	10
WGHP1325		910 x 610	13 x 25	10
WGHP2525		910 x 610	25 x 25	10
WGHPG2525	GREEN PVC COATED	910 x 610	25 x 25	10
WGHPG5050		910 x 610	50 x 50	10

### CHAIN LINK FENCING

**CORE USE**

- The wire is woven into a diamond pattern and is supplied in tight wound rolls
- Line wire included with roll

**MATERIAL**

- Galvanised or Green PVC coated

MANUFACTURED  
TO BS EN 10223-4 1998



Fence Pro

LARGE 12.5M & 25M CHAIN LINK AVAILABLE IN WIRE FENCING - ROLLS

Code	Finish	Mesh (mm)	Core Dia./ Overall Dia. (mm)	Roll Height (mm)	Roll Length (m)
WGCG100900	GALVANISED	50	2.00	900	10
WGCG101200		50	2.00	1200	
WGCP100900	GREEN PVC COATED	50	1.70/2.50	900	
WGCP101200		50	1.70/2.50	1200	

### BORDER FENCE

**CORE USE**

- Provides a decorative surround for any garden area (e.g. ponds, flower beds and garden edging)
- Self supporting fence, does not require any line wire

**MATERIAL**

- Green PVC coated



Fence Pro

Code	Finish	Roll Height (mm)	Roll Length (m)
WGNO10250	GREEN PVC COATED	250	10
WGNO10400		400	
WGNO10650		650	
WGNO10900		900	

### GARDEN FENCE

**CORE USE**

- Ideal for all garden applications
- Self supporting fence with welded cross joints so no line wire required

**MATERIAL**

- Green PVC coated



Fence Pro

Code	Finish	Roll Height (mm)	Roll Length (m)
WGTM100900	GREEN PVC COATED	900	10
WGTM101200		1200	

### BARBED WIRE

**CORE USE**

- Handy 15m coil ideal for use in the garden
- Provided in a box for safe handling

**MATERIAL**

- Galvanised, 4 point barbed wire

MANUFACTURED  
TO BS EN 10223-1 1998



200M REEL AVAILABLE IN PANELS & WIRE

Code	Finish	Type	Coil Length (m)
WGBW015	GALVANISED	Mild Steel	15

### FENCING STAKES

**CORE USE**

- Suitable for wire netting and most types of nets and meshes
- Holes enable the line wire to run through the stake

**MATERIAL**

- Green painted steel



Code	Finish	Length (mm)	Angle (mm)	Pack Qty
WGFP0900	GREEN PAINTED	900	30	1
WGFP1400		1400	30	1

### GROUND CONTROL

**CORE USE**

- Weed suppressant that is used under paths and walkways
- Heavy duty and puncture resistant so suitable for use over rough ground

**MATERIAL**

- Woven - can be cut to required length



Code	Gauge (gsm)	Roll Height (m)	Roll Length (m)	Pack Qty
WGCG09501201	90	1	12	1

### WEED CONTROL

**CORE USE**

- Easy to use weed suppressant roll
- Commonly used underneath decking
- Membrane inhibits weed growth

**MATERIAL**

- Non woven - can be cut to required length



Code	Gauge (gsm)	Roll Height (m)	Roll Length (m)	Pack Qty
WGWC201	50	1	20	1



## TIMBER TO TIMBER JOIST HANGERS

### CORE USE

- **MINI (NO LEG)**  
Ideal for ceiling hatches and similar light duty applications also extensively used in decking
- **STANDARD ("JIFFY HANGER")**  
Lightweight joist hanger providing a strong connection, quick and easy installation and enhanced performance with increased nail spacing
- **LONG LEG**  
Medium/heavy duty hanger suitable for solid and engineered joists, for loft conversions where the hanger drops below supporting beam a maximum drop of 75mm is recommended

### MATERIAL

- Galvanised for high resistance to corrosion and mechanical damage

MINI (NO LEG)



STANDARD



LONG LEG



Code	Finish	Type	Width (mm)	Leg Length (mm)	Box Qty
RJTG038M	GALVANISED	Mini (No Leg)	38	65	100
RJTG047M		Mini (No Leg)	47	65	100
RJTG050M		Mini (No Leg)	50	65	100
RJTG038		Standard	38	270	100
RJTG044		Standard	44	270	100
RJTG047		Standard	47	270	100
RJTG050		Standard	50	270	100
RJTG063		Standard	63	270	100
RJTG075		Standard	75	270	100
RJTG091		Standard	91	270	100
RJTG100		Standard	100	270	100
RJTG125		Standard	125	270	50
RJTG150		Standard	150	270	50
RJTG038L		Long Leg	38	450	20
RJTG047L		Long Leg	47	450	20
RJTG050L		Long Leg	50	450	20
RJTG063L		Long Leg	63	450	20
RJTG075L		Long Leg	75	450	20
RJTG091L		Long Leg	91	450	25
RJTG100L		Long Leg	100	450	20

## ANCHOR STRAPS

### CORE USE

- For lateral (heavy) and vertical (light) restraint against wind pressure
- Used to tie timber to brickwork or block work at floor level, eaves or ridge level
- They come in various lengths, and can be straight, bent or twisted
- Heavy are 30mm wide x 5mm thickness and light are 30mm wide x 2.5mm thickness

### MATERIAL

- Galvanised for high resistance to corrosion and mechanical damage



STRAIGHT

TWISTED

BENT

Code	Finish	Type	Type	Overall Length (mm)	Pack Qty	
RSG50060B100	GALVANISED	Heavy	Bent @ 100	600	10	
RSG50080B1		Heavy	Bent @ 100	800	10	
RSG50090B1		Heavy	Bent @ 100	900	10	
RSG5010B1		Heavy	Bent @ 100	1000	10	
RSG5012B1		Heavy	Bent @ 100	1200	10	
RSG50150B1		Heavy	Bent @ 100	1500	10	
RSG50120B15		Heavy	Bent @ 150	1200	10	
RSG50150B15		Heavy	Bent @ 150	1500	10	
RSG50160B15		Heavy	Bent @ 150	1600	10	
RSG50180B15		Heavy	Bent @ 150	1800	10	
RSG50060S		Heavy	Straight		600	10
RSG50090S		Heavy	Straight		900	10
RSG50100S		Heavy	Straight		1000	10
RSG50120S		Heavy	Straight		1200	10
RSG50150S		Heavy	Straight		1500	10
RSG50180S		Heavy	Straight		1800	10
RSG50060T15		Heavy	Twist @ 150		600	10
RSG50090T15		Heavy	Twist @ 150		900	10
RSG50100T15		Heavy	Twist @ 150		1000	10
RSG50120T15		Heavy	Twist @ 150		1200	10
RSG50150T15		Heavy	Twist @ 150		1500	10
RSG50160T15		Heavy	Twist @ 150		1600	10
RSG50180T15		Heavy	Twist @ 150		1800	10
RSG25040B1		Light	Bent @ 100		400	20
RSG25045B100		Light	Bent @ 100		450	20
RSG25060B1		Light	Bent @ 100		600	20
RSG25080B1		Light	Bent @ 100		800	20
RSG25090B1		Light	Bent @ 100		900	20
RSG25100B1		Light	Bent @ 100		1000	20
RSG25120B1		Light	Bent @ 100		1200	20
RSG25150B1		Light	Bent @ 100		1500	20
RSG25040S		Light	Straight		400	20
RSG25060S		Light	Straight		600	20
RSG25090S		Light	Straight		900	20
RSG25100S		Light	Straight		1000	20
RSG25120S		Light	Straight		1200	20
RSG25040T1		Light	Twist @ 100		400	20
RSG25060T100		Light	Twist @ 100		600	20
RSG25080T1		Light	Twist @ 100		800	20
RSG25090T1		Light	Twist @ 100		900	20
RSG25100T1	Light	Twist @ 100		1000	20	
RSG25120T1	Light	Twist @ 100		1200	20	

## BUILD IN JOIST HANGERS

### CORE USE

- For supporting timber joists and structural timber from masonry walls
- 47mm specifically for PAR timber

### MATERIAL

- One piece for structural strength
- Galvanised for high resistance to corrosion and mechanical damage



Code	Finish	Width (mm)	Size (mm)	Box Qty
RJBG047100	GALVANISED	47	100	25
RJBG047125		47	125	25
RJBG047150		47	150	25
RJBG047175		47	175	25
RJBG047200		47	200	25
RJBG047225		47	225	25
RJBG050100		50	100	25
RJBG050125		50	125	25
RJBG050150		50	150	25
RJBG050175		50	175	25
RJBG050200		50	200	25
RJBG050225		50	225	25
RJBG075150		75	150	18
RJBG075175		75	175	18
RJBG075200		75	200	18
RJBG075225		75	225	18
RJBG100200		100	200	14
RJBG100225		100	225	14



## ANGLE BRACKETS

### CORE USE

- A multi-purpose, adjustable fixing for most 90° connections
- Ideal for use on site for many substrates

### MATERIAL

- Galvanised for high resistance to corrosion and mechanical damage

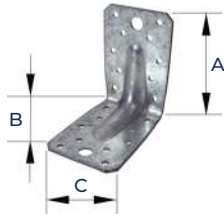

Code	Finish	Size A (mm) x B (mm) x C (mm)	Box Qty
RBRG050050	GALVANISED	50 x 50 x 60	1
RBRG060040		60 x 40 x 60	1
RBRG090090		90 x 90 x 60	1
RBRG150090		150 x 90 x 60	1
RBRG150150		150 x 150 x 60	1

## FRAMING ANCHORS

### CORE USE

- Effective and economical method of providing strong, mechanical joints for framing of timbers
- Use in pairs to avoid eccentric loading

### MATERIAL

- Galvanised for high resistance to corrosion and mechanical damage

REVERSIBLE DESIGN IDEAL FOR A VARIETY OF CONNECTIONS

BENDING SLOT ALLOWS INSTANT AND ACCURATE ONSITE BENDING FOR ALL 2 & 3 WAY TIES



Code	Finish	Size (mm)	Box Qty
RFAU	GALVANISED	120 x 40	1

## TRUSS CLIPS

### CORE USE

- For securing fixing of trusses and rafters to wall plates
- Avoids skew nailing damage and provides resistance to wind forces



Code	Finish	Width (mm)	Box Qty
RTCG038	GALVANISED	38	100
RTCG050		50	100

## NAIL PLATES

### CORE USE

- Versatile timber to timber connector which enables on site fabrication of trusses
- Can be nailed by hand or machine nailed to both faces of each abutting piece of timber

### MATERIAL

- Galvanised for high resistance to corrosion and mechanical damage

AUTOMATED CONSTRUCTION ENSURES UNIFORM HOLE POSITIONS



Code	Finish	Size (mm)	Box Qty
RZNP050150	GALVANISED	50 x 150	10
RZNP080150		80 x 150	10
RZNP080200		80 x 200	10
RZNP100150		100 x 150	10
RZNP100200		100 x 200	10

## HERRINGBONE STRUTS

### CORE USE

- Used to give lateral support between timber floor joists and helps prevent joists twisting
- Gives superior bracing over unreliable, slow and costly timber noggins

### MATERIAL

- Galvanised for high resistance to corrosion and mechanical damage



Code	Finish	Centre Length (mm)	Overall Length (mm)	Box Qty
RHSG400	GALVANISED	400	480	100
RHSG450		450	530	100
RHSG600		600	710	100

## GALLOWS BRACKETS

### CORE USE

- Used for supporting chimneys after the removal of the chimney breast
- Bolt to the wall with masonry fixings within the loft area of the house

### MATERIAL

- Heavy duty brown powder coated welded steel brackets

HOOK DESIGNED TO EMBED INTO THE BRICKWORK FOR ADDITIONAL STRENGTH

BRACKET IS BOLTED TO THE WALL THROUGH THIS EDGE OF THE UPRIGHT

UPRIGHT PREDRILLED WITH 12 HOLES

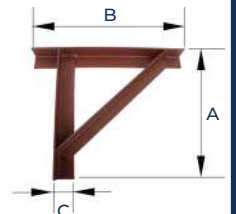

Code	Finish	Height A (mm)	Projection B (mm)	Angle C (mm)	Material Thickness (mm)	Pairs Per Pack
RBGG045	BROWN	380	490	50 x 50	5	1
RBGG049		380	490	75 x 75	6	1

## FIXING BANDS

### CORE USE

- Versatile multi-purpose fixing band
- Can be used for many fixing jobs with up to 6 diameter nails, screws or bolts

### MATERIAL

- Galvanised for high resistance to corrosion and mechanical damage



Code	Finish	Width (mm)	Roll Length (m)
RFBZ10201	GALVANISED	20	10

Square Twist Nails complement our builders metalwork products

See our Boxed Nails section for loose and collated Square Twist Nails





## DOUBLE TRIANGULAR WALL TIES

Traditional double triangular wall tie with multi-drip.

A2

### CORE USE

- Designed to prevent moisture travelling across the cavity
- Place across the cavity and tie the 2 skins by embedding in mortar

### MATERIAL

- 304/A2 Stainless Steel for ultimate corrosion resistance



Code	Material	Size (mm)	To Suit Cavity (mm)	Max Building Height (m)	Pack Qty
RWTSD225	STAINLESS STEEL	225	76 - 100	15	250
RWTSD250		250	101 - 125	15	250
RWTSD300		300	126 - 150	15	250

## TYPE 4 WALL TIES

### CORE USE

- Light duty wall tie suitable for domestic dwellings with leaves of similar thickness (replaces butterfly tie)
- Designed for cavities in external walls of domestic houses up to 10m in height

### MATERIAL

- 304/A2 Stainless Steel for ultimate corrosion resistance

**KINKED DESIGN**  
ALLOWS CONDENSATION TO FALL FROM THE TIE TO MINIMISE THE POTENTIAL FOR CORROSION

A2

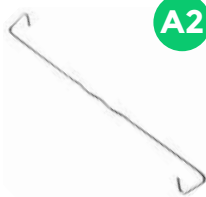

Code	Material	Size (mm)	To Suit Cavity (mm)	Max. Building Height (m)	Pack Qty
RWTSH200	STAINLESS STEEL	200	50 - 75	10	250
RWTSH225		225	76 - 100	10	250
RWTSH250		250	101 - 125	10	250
RWTSH275		275	126 - 150	10	250
RWTSPH225		225	76 - 100	10	20
RWTSPH250		250	101 - 125	10	20

## TIMBER FRAME TIES

### CORE USE

- A flexible tie which secures brick and block work cladding to the timber frame structures up to and including 4 storeys
- The bending slot allows instant and accurate bending for all 2 and 3 way ties

### MATERIAL

- 304/A2 Stainless Steel for ultimate corrosion resistance

A2



**EACH TIE SUPPLIED WITH A STAINLESS STEEL ANNULAR RING NAIL**

Code	Material	Size (mm)	To Suit Cavity (mm)	Pack Qty
RWTTF125	STAINLESS STEEL	125	50 - 75	250
RWTTF175		175	100	250

## TYPE 2 WALL TIES

### CORE USE

- General purpose wall tie for domestic and small commercial buildings
- For internal separating walls of new build attached dwellings, use Type 4 Wall Tie

### MATERIAL

- 304/A2 Stainless Steel for ultimate corrosion resistance

**KINKED DESIGN**  
ALLOWS CONDENSATION TO FALL FROM THE TIE TO MINIMISE THE POTENTIAL FOR CORROSION

A2

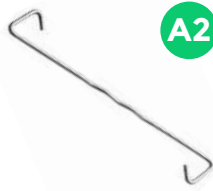

Code	Material	Type (mm)	To Suit Cavity (mm)	Max Building Height (m)	Pack Qty
RWTT2225	STAINLESS STEEL	225	76 - 100	15	250
RWTT2250		250	101 - 125	15	250
RWTPT2225		225	76 - 100	15	20
RWTPT2250		250	101 - 125	15	20

## WALL STARTER KITS

### CORE USE

- Ties in new masonry walls from 60-250mm wide and up to 3 storeys high
- The wall ties clip to any position, eliminating any problems with matching brickwork courses

### MATERIAL

- 430 Stainless Steel for ultimate corrosion resistance



**SUPPLIED WITH ALL NECESSARY FIXINGS**

PACKS CONTAIN:  
2 x 1200MM SECTIONS WHICH CAN BE FIXED INDEPENDENTLY OR CUT TO A REQUIRED LENGTH

Code	Finish	Size	Pack Qty
RWSKS	STAINLESS STEEL	2.4m per pack	10

## WALL TIE INSULATION CLIPS

Also known as "universal insulation retaining discs" or "cavity clips/discs".

### CORE USE

- Used to hold insulation material back to structure
- Suitable for all cavity wall ties



Code	Material	Diameter (mm)	Pack Qty
RWTICU	PLASTIC	75	250
RWTPICU		75	20

## STARTER TIES WITH PLUGS

### CORE USE

- For use in brickwork and blockwork of up to 3 storeys or 8m in height

### MATERIAL

- 304/A2 Stainless Steel screw-in ties with nylon plugs



A2

Code	Material	Size	Pack Qty
RWTST130	STAINLESS STEEL	130mm with 8mm Nylon Plug	100
RWTPT130		130mm with 8mm Nylon Plug	10

## DOOR FRAME CRAMPS

### CORE USE

- To tie timber door/window frames to adjacent brickwork
- Fix using nails or screws to timber and embed other end in mortar

### MATERIAL

- Fish tail end galvanised steel to BS EN 10345:2009 DX51D+G275
- Safety end Stainless Steel to 304/A2

SAFETY END

FISH TAIL END  
50MM UPSTAND  
3 FIXING HOLES



Code	Finish	End Type	Size	Pack Qty
RFCG1005	GALVANISED	Safety	100	250
RFCG1505		Safety	150	250
RFCG2005		Safety	200	250
RFCGF1005		Fish Tail	100	250
RFCGF1505		Fish Tail	150	250
RFCGF2005		Fish Tail	200	250
RFCSS1005	STAINLESS STEEL	Safety	100	250
RFCSS1505		Safety	150	250
RFCSS2005		Safety	200	250

## CRACK STITCHING PRODUCTS

### CRACK STITCHING KIT

#### CORE USE

- Cost effective and economical solution of reconnecting cracked masonry or brick
- It involves installing crack stitching bars which are grouted across cracks to add strength

EXCELLENT BONDING CHARACTERISTICS  
STRONG & FLEXIBLE



#### COMPLETE KIT CONTAINS:

- 10 x A2 stainless steel helical bars (6mm x 1000mm)
- 1 x 3 litre tub of Cementitious Grout
- 1 x Crack-stitching gun
- 1 x Stainless steel nozzle
- 1 x Mixing paddle
- 1 x Finger trowel

Code	Pack Qty
RWTCSK	1

## SCREW IN FRAME TIES

### CORE USE

- To tie timber door/window frames to adjacent brickwork
- Fix by screwing to timber and embed end in mortar between the brick courses

### MATERIAL

- Zinc & Yellow Passivated for improved corrosion resistance



Code	Finish	Size (mm)	Pack Qty
RFSG	ZINC & YELLOW PASSIVATED	5.5 x 150	100

## GROUT FOR CRACK STITCHING

### CORE USE

- Cementitious grout for use with stainless steel helical bars
- When used with the bars, provides an economical and non-disruptive way to repair vertical or stepped cracks in masonry



ONE TUB OF GROUT IS ENOUGH TO COVER 10 LINEAR METRES OF REPAIR

Code	Colour	Size (litres)	Pack Qty
RWTG030	GREY	3	1

## WATER BARS

### CORE USE

- Helps to seal gaps to prevent water and wind from going between the door and the threshold
- Traditionally used for wooden doors - fitted into the threshold

### MATERIAL

- Galvanised mild steel for use in exterior door thresholds



Code	Finish	Size (mm)	Length (m)	Pack Qty
RWBG100	GALVANISED	28 x 4	1	1
RWBG200		28 x 4	2	1

## HELICAL BARS FOR CRACK STITCHING

### CORE USE

- Used with cementitious grout to permanently repair vertical or stepped cracks in masonry
- Chemically bond into horizontal slots to stitch across the crack

NO COSTLY RECONSTRUCTION WORK  
NO INCONVENIENCE TO THE  
BUILDING'S INHABITANTS



A2

Code	Material	Length (mm)	Width (mm)	Pack Qty
RWTHB061000	STAINLESS STEEL	1000	6	10
RWTHB081000		1000	8	10

We also stock a full range of **weatherbars and door surrounds** in our Ironmongery section...

...the range includes deflectors, door seals, draught excluders and joinery seals.





## ANGLE/CORNER BEADS

### CORE USE

- Gives a strong and straight external corner
- uPVC designed for 2 and 3 coat applications

### MATERIAL

- Galvanised for internal use
- uPVC/stainless steel are ideal externally or in marine environments
- 430 Stainless Steel for ultimate corrosion resistance

GALV/STAINLESS STEEL



UPVC WHITE



Code	Finish	Wing/Flange (mm)	Plaster Depth (mm)	Length (m)	Pack Qty
RABG2445	GALVANISED	45	-	2.4	50
RABG3045		45	-	3.0	50
RABS3045	STAINLESS STEEL	45	-	3.0	25
RABUW250610	UPVC WHITE	-	6 - 10	2.5	50
RABUW250812		-	8 - 12	2.5	40
RABUW251319		-	13 - 19	2.5	30

## MINI MESH

### CORE USE

- Provides excellent adhesion and reinforcement
- For single coat plaster applications including dry wall, block and slab work

### MATERIAL

- Galvanised for internal use

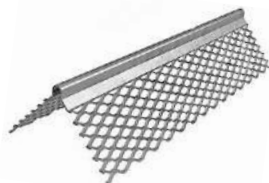

Code	Finish	Wing/Flange (mm)	Length (m)	Pack Qty
RAMG2428	GALVANISED	25	2.4	50
RAMG3028		25	3.0	50

## PERFORATED THIN COAT ANGLE BEADS

### CORE USE

- Designed for standard single coat plasterwork as they protect and reinforce all the most vulnerable points
- The nail holes provide an easy way to fix

### MATERIAL

- Galvanised for internal use
- uPVC is ideal externally or in marine environments

GALVANISED



UPVC WHITE



Code	Finish	Wing/Flange (mm)	Plaster Depth (mm)	Length (m)	Pack Qty
RATG2422	GALVANISED	22	-	2.4	50
RATG3022		22	-	3.0	50
RATUW250203	UPVC - WHITE	-	2 - 3	2.5	50

## ARCH BEADS

### CORE USE

- Enables definition to be given to drylined arches and curves
- Can also be used externally or in marine environments

FLEXIBLE ENOUGH TO FORM A 250MM RADIUS



Code	Finish	Plaster Depth (mm)	Length (m)	Pack Qty
RAAU250203	UPVC - WHITE	2 - 3	2.5	50

## STOP BEADS

### CORE USE

- Provides a clean, neat edge to 2 coat plaster and render work at openings or abutments onto other wall or ceiling finishes

### MATERIAL

- Galvanised for internal use
- uPVC/stainless steel are ideal externally or in marine environments
- 430 Stainless Steel for ultimate corrosion resistance

GALV/STAINLESS STEEL



UPVC WHITE



Code	Finish	Width (mm)	Plaster Depth (mm)	Length (m)	Pack Qty
RASG2410	GALVANISED	10	-	2.4	50
RASG2413		13	-	2.4	50
RASG2416		16	-	2.4	50
RASG3010		10	-	3.0	50
RASG3013		13	-	3.0	50
RASS3010		STAINLESS STEEL	10	-	3.0
RASS3013	13		-	3.0	25
RASUW250203	UPVC WHITE	-	3	2.5	50
RASUW250608		-	6 - 8	2.5	50
RASUW251013		-	10 - 13	2.5	50
RASUW251517		-	15 - 17	2.5	50
RASUW252022		-	20 - 22	2.5	50

## PERFORATED THIN COAT STOP BEADS

### CORE USE

- Designed for thin coat edge protection at openings or abutments onto other wall finishes
- Hole pattern ensures embedment of the bead in the finish

### MATERIAL

- Galvanised for internal use



Code	Finish	Width (mm)	Length (m)	Pack Qty
RASG2403	GALVANISED	3	2.4	50
RASG3003		3	3.0	50

## EXTERNAL RENDER STOP BEADS

Also known as "Bellcast External Render Stop Beads".

### CORE USE

- Used to obtain a neat bellcast edge to external finishes
- It protects and reinforces the render where it is most vulnerable
- The expanded mesh wing ensures the bead is fully embedded in the render - it can also be used with EML
- Gives good protection to masonry from run off water

### MATERIAL

- Galvanised for sheltered situations away from the coast
- uPVC/Stainless Steel are ideal externally or in marine environments
- 430 Stainless steel for ultimate corrosion resistance

GALV/STAINLESS STEEL



UPVC WHITE



Code	Finish	Width (mm)	Length (m)	Pack Qty
RARG24	GALVANISED	-	2.4	25
RARG30		-	3.0	25
RARS30	STAINLESS STEEL	-	3.0	25
RARUW251222	UPVC - WHITE	12 - 22	2.5	50



## EXPANDED METAL LATHING

Also known simply as "EML".

### CORE USE

- Suitable for encasing columns and beams, span small openings
- Also as an aid to fire protection
- Can be used for suspended ceilings and partitions
- Ideal for external and rough cast masonry render

### MATERIAL

- Galvanised for internal use
- 430 Stainless Steel for use externally and in marine environments

SUPERIOR JOINT & CRACK REINFORCEMENT



Code	Finish	Size (mm)	Thickness (mm)	Pack Qty
RALG823	GALVANISED	2440 x 685	4	10
RALS823	STAINLESS STEEL	2500 x 700	4	1

## EXPANDED BRICK REINFORCEMENT

### CORE USE

- Used in the construction of brick and block masonry
- Fix into mortar between brick courses leaving 25mm clearance from face of brickwork
- All joints require an overlap of at least 75mm

ANTI-CRACKING



Code	Material	Width (mm)	Length (m)	Pack Qty
RAEG020061	GALVANISED	61	20	1
RAEG020112		112	20	1
RAEG020178		178	20	1
RAEG020228		228	20	1
RAEG020305		305	20	1
RAES020061	A2 STAINLESS STEEL	65	20	1
RAES020112		100	20	1
RAES020178		175	20	1
RAES020228		225	20	1

## PLASTERERS SCRIM TAPE

### CORE USE

- Used before finishing/skimming plaster or artex/textured finishes to reduce the risk of cracking on plasterboard joints, walls and ceilings

### MATERIAL

- Self adhesive fibreglass mesh



Code	Finish	Width (mm)	Length (m)	Pack Qty
RAPS5090	-	50	90	24
RAPS9990		100	90	1

## RENDER MESH

### CORE USE

- Ideal for use in construction and mainly used for reinforcing concrete, cement, screeds, renders and plasters

### MATERIAL

- A reinforcing mesh made from woven fibreglass yarns and coated with an alkaline resistant latex



Code	Finish	Length (m)	Width (m)	Thickness (gsm)	Rolls Per Pack
RALP0501	WHITE MESH	50	1	160	1

## BUCKETS

Our **flexi-tub** buckets and **rigid** buckets are an **essential** on site and in the home.

Available in **two colours** and **can be purchased individually**.

### FLEXI-TUB BUCKETS

#### CORE USE

- Variety of uses including on site and in the home
- Medium or large buckets with strong handles for easy carrying

#### MATERIAL

- Made from flexible, recycled plastic



Code	Colour	Capacity (litres)	Pack Qty
RBUBF20B	BLACK	26	1
RBUBF40B		42	1
RBUBF20Y	YELLOW	26	1
RBUBF40Y		42	1

### RIGID BUCKETS

#### MATERIAL

- Durable, rigid plastic buckets with pouring lip and plastic covered wire handle
- Internal measurement markings to help with mixing
- Holds up to 3 gallons (14 litres)



Code	Colour	Capacity	Pack Qty
RBUBPB	BLACK	3 Gallons / 14 Litres	1
RBUBPY	YELLOW	3 Gallons / 14 Litres	1

## RENDER MESH

Our render mesh is **160gsm** thickness, **4x4mm** mesh

Tensile Strength  
**Warp: 1500 N/50mm**  
**Woof: 1800 N/50mm**

The **latex coating** prevents the alkaline present in the cements from **degrading the glass fibre** and **reducing strength**.

## ZEDEX HIGH PERFORMANCE CPT DPC

### CORE USE

- 0.8mm DPC suitable for damp proofing and cavity trays in all solid/cavity wall applications

### MATERIAL

- Made of Co-Polymer Thermoplastic (no Bitumens, no PVC) and also acts as a radon resistant DPC
- Manufactured to Type A EN 14909
- Resistant to compression under heavy wall loading and won't extrude



Code	Width (mm)	Roll Length (m)	Rolls Per Pack
RDHY100	100	20	1
RDHY1125	112.5	20	1
RDHY150	150	20	1
RDHY225	225	20	1
RDHY300	300	20	1
RDHY3375	337.5	20	1
RDHY450	450	20	1
RDHY600	600	20	1
RDHY900	900	20	1

## INSULATED DPC

### CORE USE

- Developed to close masonry cavities around window and door reveals

### MATERIAL

- Polyethylene manufactured to BS6515



COMPLIES WITH PART L OF BUILDING REGULATIONS UNDER CERTAIN CONDITIONS

Code	Insulation (mm)	DPC Width (mm)	Roll Length (m)	Rolls Per Pack
RDPV165	17 x 100	165	10	6
RDPV225	17 x 140	225	10	5

## CAVITY CLOSERS

### CORE USE

- Economical solution to cold bridging problems
- Provides a thermal break to the cavity
- Acts as an effective DPC barrier

TO SUIT CAVITY WIDTHS BETWEEN 50-100 & 100-150

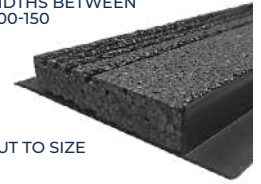

CAN BE CUT TO SIZE

COMPLIES WITH PART L OF BUILDING REGULATIONS UNDER CERTAIN CONDITIONS

Code	Colour of Extrusion	To Suit Cavity (mm)	Length (m)	Pack Qty
RCCU1002440	GREY	50 - 100	2.44	10
RCCU1502440		100 - 150	2.44	10

## ZEDEX HOUSING GRADE DPC

### CORE USE

- 0.6mm DPC ideal for damp proofing solid and cavity walls in stonework, brick, block or concrete
- Usable under concrete floor beams
- Suitable for residential masonry applications up to 3 storeys high
- Can be formed into a built-in or surface fixed cavity tray

### MATERIAL

- Domestic grade polymeric DPC including elastomers



Code	Width (mm)	Roll Length (m)	Rolls Per Pack
RDHYB100	100	20	1
RDHYB1125	112.5	20	1
RDHYB150	150	20	1
RDHYB225	225	20	1
RDHYB300	300	20	1
RDHYB450	450	20	1
RDHYB600	600	20	1
RDHYB900	900	20	1

## POLYTHENE FILM

### CORE USE

- Temporary protection sheeting and damp proof membrane
- Used to prevent moisture penetration from floors
- DPM & Radon are BBA certified



Code	Description	Colour	Approx. Roll Weight (kg)	Approx. Thickness (mu)	Width x Length (m)	Rolls Per Pack
RDSPT0254040	Light Duty Prot Sheet	Clear	4.5	N/A	4 x 25	1
RDSPT0254060	Medium Duty Prot Sheet	Clear	6	N/A	4 x 25	1
RDSPT0504060		Clear	11	62.5	4 x 50	1
RDSPT0254120	Heavy Duty Prot Sheet	Clear	11	120	4 x 25	1
RDSPD0254250	Blue DPM (BBA)	Blue	23	250	4 x 25	1
RDSPD0254300		Blue	27	300	4 x 25	1
RDSPD01254500		Blue	24	500	4 x 12.5	1
RDSPB0254250	Black DPM (BBA)	Black	23	250	4 x 25	1
RDSPB0254300		Black	27	300	4 x 25	1
RDSPB01254500		Black	24	500	4 x 12.5	1
RDSR0254300	Radon Barrier (BBA)	-	27	400	4 x 20	1
RDSV05025125	Vapour Barrier	Green	14	125	2.45 x 50	1

## POLYETHYLENE DPC

### CORE USE

- Cost effective damp proof course for domestic construction
- Suitable for use in horizontal and vertical applications

### MATERIAL

- Safe and clean to handle
- Flexible even at low temperatures

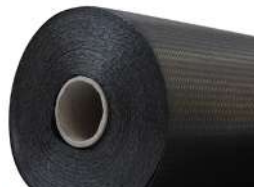

Code	Width (mm)	Roll Length (m)	Rolls Per Pack
RDPO100	100	30	9
RDPO1125	112.5	30	8
RDPO150	150	30	6
RDPO225	225	30	4
RDPO300	300	30	3
RDPO3375	337.5	30	3
RDPO450	450	30	2
RDPO600	600	30	2
RDPO900	900	30	1

## EXPANSION JOINT FILLER

### CORE USE

- Used in concrete slab construction and brickwork joints as resistant to attack by most acids and alkalis

### MATERIAL

- Expanded polyethylene foam



Code	Thickness (mm)	Width (mm)	Roll Length (m)	Rolls Per Pack
REJFF1010100	10	100	10	10
REJFF1010150	10	150	10	5
REJFF1010200	10	200	10	5

## COMBINATION AIRBRICK

### REGULATIONS

BS 493:1995+A1:2010  
Specification for airbricks and gratings for wall ventilation

### AIRFLOW

6,450MM<sup>2</sup> PER 9" X 3" AIRBRICK

**CAN BE STACKED TOGETHER TO CREATE 9" X 6" & 9" X 9" COMBINATIONS**

**SUITABLE FOR GAS APPLIANCES**

### CORE USE

- Designed to provide high levels of ventilation into cavity walls and underfloor voids
- Incorporates a front mounted grille with water deflectors
- A mortar key around the edge of the airbrick ensures it can be securely fixed to the building fabric
- The clip together facility provides a choice of ventilation sizes



Code	Material	Colour	Size (inch)	Pack Qty
RVAB0903BU	POLYPROPYLENE	Buff	9" x 3"	20
RVAB0903TE		Terracotta	9" x 3"	20

## COMBINATION CAVITY SLEEVE

### REGULATIONS

BRE Digest 17  
BRE Digest 262  
Building Regulations C4  
NHBC Standards 5.2  
BS 5250:2011 Control of Condensation in Building

**CAN BE STACKED TOGETHER TO CREATE 9" X 6" & 9" X 9" COMBINATIONS**

**TELESCOPIC TO FIT CAVITY WIDTHS OF 50-100MM**

**TO BE USED WITH AIRBRICKS AND VENTS**

### CORE USE

- Fits into the back of the airbrick to ventilate through a standard cavity or solid brick wall
- Will also act as an extension to the underfloor vent
- Further extension possible through the addition of extra product units

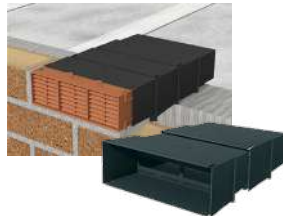

Code	Material	Size (inch)	Pack Qty
RVABUFCSBL	HIGH IMPACT STYRENE	9" x 3"/6"/9"	10

## SQUARE/ROUND ADAPTER

### REGULATIONS

BRE Digest 17  
BRE Digest 262  
Building Regulations C4  
NHBC Standards 5.2  
BS 5250:2011 Control of Condensation in Building

**AIRFLOW 8,800MM<sup>2</sup>**

**CAN BE EASILY CUT DOWN TO FIT THE AIRBRICK**

Also known as "remote void ventilator".

### CORE USE

- Designed to connect the airbrick or underfloor vent to a 4" round pipe
- Fits directly onto the bottom of the underfloor vent



Code	Material	Size	Pack Qty
RVABUFADBL	HIGH IMPACT STYRENE	74 x 236mm to 4" dia.	10

## TELESCOPIC UNDERFLOOR VENTS & EXTENSION SLEEVES

### REGULATIONS

BRE Digest 17  
BRE Digest 262  
Building Regulations C4  
NHBC Standards 5.2  
BS 5250:2011 Control of Condensation in Building

### TELESCOPIC UNDERFLOOR VENT

- Designed to provide a clear airflow passage to the void underneath a suspended floor
- The right airflow can be achieved when the ventilator is used with an airbrick
- The aperture can also accept a standard clay airbrick, although the airflow is reduced
- Additional depth and cavity span available with extension sleeve

**AIRFLOW 6600 MM<sup>2</sup>**

**VERTICAL TELESCOPIC ADJUSTMENT OF 3-5 BRICK COURSES**



### EXTENSION SLEEVE FOR UNDERFLOOR VENT

- Can be used with the standard telescopic underfloor vent allowing the vent to reach a further 2 brick courses vertically
- Can be fitted to the base of the telescopic vent to provide horizontal extension through larger cavities
- Allows a 3-5 course stagger + 2 courses per unit (a further 150mm vertically or 185mm horizontally)

**AIRFLOW 6600 MM<sup>2</sup>**



### DUAL EXTENSION UNDERFLOOR VENT

- Designed to provide a clear airflow passage to a void beneath an insulated suspended floor
- Increased depth of thermal insulation in suspended floors and increased cavity widths to accommodate greater amounts of cavity wall insulation
- Clear access to an underfloor void can be up to 6 or 7 brick courses (525mm) below the level of an airbrick and potentially as much as 350mm from the outer face of the external leaf
- The front aperture is designed for use with a combination airbrick or it can be used in conjunction with a traditional clay airbrick, although this would reduce the overall airflow through the system

**AIRFLOW 8000 MM<sup>2</sup>**

**VERTICAL TELESCOPIC ADJUSTMENT OF 5-8 BRICK COURSES WITHOUT THE NEED FOR EXTENSION SLEEVE**

**HORIZONTAL OUTLET CAN BRIDGE THROUGH A WALL THICKNESS OF 350MM WITHOUT THE NEED FOR ADDITIONAL EXTENSION**



Code	Material	Description	Size (courses)	Pack Qty
RVABUFVEBL	BLACK POLYPROPYLENE	Telescopic Underfloor Vent	3-5	20
RVABUFEXBL		Extension Sleeve for Telescopic Underfloor Vent	2+	20
RVABUFDEBL		Dual Extended Underfloor Vent	5-8	16

# AIRBRICKS

Allow **greater airflow** whilst **preventing ingress of rain**, insects and **avoid blocking** by debris.

They have a **discrete appearance** and overall **aesthetics are maintained.**



## WEEP VENTS

DESIGNED FOR DISCREET CAVITY WALL DRAINAGE & VENTILATION REQUIREMENTS

WEEP VENTS CAN BE USED TO DRAIN DPCS, CAVITY TRAYS AND LINTELS ALONG WITH PROVIDING AIRFLOW CIRCULATION TO TIMBER FRAME CAVITY WALLS

REFURBISHMENT WEEPS ARE AVAILABLE FOR RETROFITTING VENTILATION INTO EXISTING DETAILS

Our range of weep vents can be used to drain DPCs, cavity trays and lintels along with providing airflow circulation to timber frame cavity walls

### STANDARD WEEP VENTS

#### REGULATIONS

BRE Digest 262  
BS 5250:2011 Control of Condensation in Building  
NHBC Standards 6.2 External timber framed walls  
The Building Regulations (Scotland) 3.10.6 Masonry outer leaf

#### CORE USE

- Used to drain lintels, cavity trays and to ventilate cavity walls
- Provides 220mm<sup>2</sup> ventilation airflow
- Can be slotted between two bricks and mortared into position to provide an unobtrusive ventilation point for the cavity behind
- It should be spaced at no greater than 900mm centres to meet N.H.B.C guidelines

#### MATERIAL

- It has a baffled grille to prevent the ingress of driving rain and wind
- Incorporates an insect grille and drip lip
- The grille is sized to keep out large insects but is wide enough that it will not be blocked by debris, paint or water droplets



Code	Material	Colour	Size (mm)	Pack Qty
RVWVSBU	POLYPROPYLENE	Buff	100 x 65 x 9	50
RVWVSTE		Terracotta	100 x 65 x 9	50

### PEEP WEEP VENTS

#### REGULATIONS

BRE Digest 262  
BS 5250:2011 Control of Condensation in Building  
NHBC Standards 6.2 External timber framed walls  
The Building Regulations Approved Document C

#### CORE USE

- Provides an unobtrusive solution to cavity wall drainage requirements (drains lintels and cavity trays)

#### MATERIAL

- The weep features a mortar key to ensure adhesion to the building fabric and an external rib to aid positioning
- The rib surrounds a 62mm high opening to prevent mortar blockage from within the cavity
- The weep's protective hood which when fitted "peeps" out from the brick fascia is designed to guard against blockage during installation and stops penetration of wind driven rain
- The exit hole is ample for water drainage but small enough to prevent entry of large insects



Code	Material	Colour	Size (mm)	Pack Qty
RVWVPBU	POLYPROPYLENE	Buff	105.5 x 62 x 9	100
RVWVPTE		Terracotta	105.5 x 62 x 9	100

### REFURBISHMENT WEEP VENTS

#### REGULATIONS

BS 5250:2011 Control of Condensation in Building  
Building Regulations 2000: 5.5  
Scottish Building Regulations 2007: 3.10.6  
NHBC Standards 6.1 D6  
NHBC Standards 6.2 D4

#### CORE USE

- Designed to provide retrospective ventilation to cavity walls where no or an insufficient amount of weep vents have been used
- Can also be used to ventilate rendered wall where standard weep vents are notoriously difficult to detail
- Installed in a 25mm diameter drilled hole
- Provides 260mm<sup>2</sup> ventilation airflow per unit

#### MATERIAL

- Louved chevron grill helps to protect against wind driven rain & insect ingress
- The external flange covers any damage to the substrate caused by the drilling
- Drip rib ensures clean moisture run off
- Tube ribs ensure easy lead in to the hole and help retain the vent in position



Code	Material	Colour	Size (mm)	Pack Qty
RVWVRBU	POLYPROPYLENE	Buff	80 x 25 dia.	50
RVWVRTE		Terracotta	80 x 25 dia.	50
RVWVRCL		Clear	80 x 25 dia.	50



### ACCESS PANELS

#### CORE USE

- For quick and simple entry to concealed plumbing, electrics and other utilities

#### MATERIAL

- High impact polystyrene: cost effective and lightweight with a smooth textured finish which can be painted over
- Fully detachable panel door which can be removed for convenience



**MODULAR DESIGN**  
ALLOWS FOR INSTALLATION  
IN A MATTER OF MINUTES

**FLUSH-FIT FINISH**  
FITS ANY MODERN KITCHEN  
OR BATHROOM

Code	Material	Colour	Size (mm)	Pack Qty
RVACC100150	High Impact Polystyrene	White	100 x 150	20
RVACC150200	High Impact Polystyrene	White	150 x 200	20
RVACC300300	High Impact Polystyrene	White	300 x 300	10

### BIRD SPIKES

#### CORE USE

- Designed to prevent birds perching or nesting
- Ideal for use on ledges, sills, roofs and ridges
- Base contains convenient break marks

#### MATERIAL

- A4 Stainless Steel spikes mounted on a clear polycarbonate base

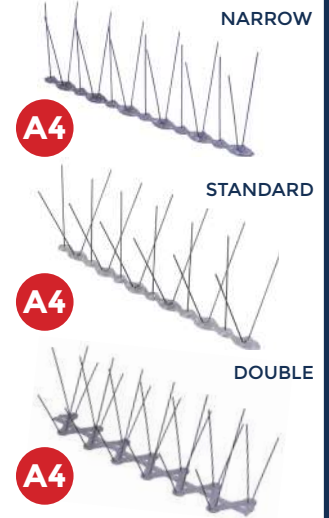

Code	Material	Type	Size (mm)	Pack Qty
RBSPD011	STAINLESS STEEL	Narrow	55 x 110 x 313	10
RBSPD012		Standard	100 x 110 x 313	10
RBSPD013		Double	140 x 115 x 313	10

### INSECT MESH

#### CORE USE

- Ideal for window & door screens, roof soffit ventilation, cladding, rainscreening, and other industrial applications

#### MATERIAL

- Flexible fibreglass reinforcement mesh which is fused at each joint for strength and then coated with black PVC

#### SIZE

- 18 x 16 x 0.11 x 30m



Code	Material	Width (mm)	Length (m)	Pack Qty
RIMFB0300075	BLACK FIBREGLASS	75	30	1
RIMFB0300100		100	30	1
RIMFB0300150		150	30	1
RIMFB0301200		1200	30	1

### SOFFIT VENT MESH

#### CORE USE

- For use in new build properties
- Used over vents in soffits to allow airflow to avoid condensation
- Prevents access to birds and insects

#### MATERIAL

- A2 Stainless Steel to BS EN 1.4301

LIGHTWEIGHT  
SUPPLIED IN A DISPENSER

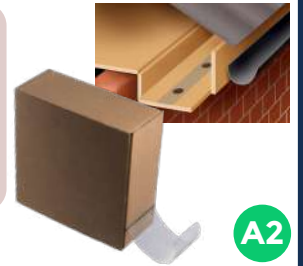

Code	Material	Width (mm)	Length (m)	Rolls Per Pack
RASMS075030	STAINLESS STEEL	75	30	1

Plastic products essential for the warehouse and on site!

### PALLET WRAP

Also known as "shrink wrap".

#### CORE USE

- Most commonly used for wrapping around items on a pallet
- Ensures the items are tightly bound and secured for transit

INDOOR & OUTDOOR USE  
HIGH STRENGTH  
PUNCTURE RESISTANT  
EXTENDED CORE



Code	Colour	Width (mm)	Length (m)	Thickness (mu)	Box Qty
RDSPW40025020	CLEAR	400	250	20	6

### RUBBLE SACKS

#### CORE USE

- For aggregate and builders rubble

#### MATERIAL

- Heavy duty polythene sacks
- Reinforced seams ensure that the bags do not split under heavy loading



Code	Colour	Thickness (mu)	Approx. Thickness (g)	Width x Length (mm)	Pack Qty
RDSPR500730	BLACK	100	400	500 x 730	100
RDSPR530840		125	500	515 x 810	100

## GREEN MINERAL FELT MEDIUM

### CORE USE

- An economical method of waterproofing temporary or garden structures
- Ideal for use as a roof covering on apex and non-habitable garden buildings, animal shelters and sheds

### MATERIAL

- Glass fibre based oxidised roofing membrane finished with a green medium slate mineral upper surface



PRODUCED TO STANDARD  
BS EN 13707: 2013

Code	Finish	Type	Size (m)	Roll Weight (kg)	Coverage (m <sup>2</sup> )	Rolls Per Pack
RRF10	GREEN	1B	5 x 1	10	4.75	1
RRF20		1B	10 x 1	20	9.5	1

## ROOFING FELT BS747

### CORE USE

- Ideal as a waterproof underlay on flat roofs
- Can also be used as an intermediate layer and cap sheet/top layer in a traditional built up flat roof system, adhered with hot poured bitumen

### MATERIAL

- Recycled rag fibre based oxidised roofing membrane
- Finished with a black sand upper surface



PRODUCED TO STANDARD  
BS EN 13707: 2013

Code	Finish	Type	Size (m)	Roll Weight (kg)	Coverage (m <sup>2</sup> )	Rolls Per Pack
RRF14	BLACK	1B	10 x 1	14	9.5	1
RRF18		1B	10 x 1	18	9.5	1

## GREEN MINERAL FELT HEAVY

### CORE USE

- Ideal as a top sheet in built-up roofing
- Also for use as a garden outbuilding weatherproofing layer or as underlays, intermediate and top layers in a traditional built-up flat roof system, adhered with hot poured bitumen

### MATERIAL

- Recycled rag fibre based oxidised roofing membrane, finished with a green slate mineral upper surface



PRODUCED TO STANDARD  
BS EN 13707: 2013

Code	Finish	Type	Size (m)	Roll Weight (kg)	Coverage (m <sup>2</sup> )	Rolls Per Pack
RRF38	GREEN	1E	10 x 1	38	9.5	1

## SLATERS FELT TYPE 1F BS747

### CORE USE

- For use under tiles and slates where the felt is not fully supported by boarding
- Acts as a secondary waterproof layer and to prevent wind uplift

### MATERIAL

- Hessian reinforced core coated with liquid bitumens



PRODUCED TO STANDARD  
BS EN 13707: 2013

Code	Finish	Type	Size (m)	Roll Weight (kg)	Coverage (m <sup>2</sup> )	Rolls Per Pack
RRFLAT	BLACK	1F	15 x 1	22.5	14.25	1

## DEBRIS NETTING

### CORE USE

- For use in construction and scaffolding to protect workers and the public
- Can be used for a barrier or as a general netting in gardens or allotments

### MATERIAL

- Made from UV stabilised polyethylene mono-filaments which creates an open mesh netting



Code	Colour	Width (m)	Roll Length (m)	Rolls Per Pack
RYDNG05002	GREEN	2	50	1

## HESSIAN FROST PROTECTION SHEET

### CORE USE

- For shielding brickwork, mortar and other work in progress from frost and bad weather (when dampened)

ALSO AVAILABLE TO PURCHASE BY THE PALLET



Code	Size	Size	Pack Qty
RYHFP	46m x 1370mm	50 Yards x 54"	1

## KINDLING NET BAGS

- Leno woven polypropylene net sack
- Supplied empty



Code	Size (mm)	Pack Qty
RYKN450600G	450 x 600	100

## SANDBAGS

### CORE USE

- Supplied empty with integral drawstring

### MATERIAL

- Rot proof have been chemically treated to minimise decomposition



Code	Type	Size (mm)	Size (inch)	Pack Qty
RYSBHE	Standard Hessian	330 x 762	13" x 30"	50
RYSBRP	Rot Proof Hessian	330 x 762	13" x 30"	50
RYSBPP	Polypropylene - White	330 x 762	13" x 30"	100

### TARPAULIN

#### CORE USE

- For temporary roof protection, to act as a ground sheet or as a general utility cover

#### MATERIAL

- Reinforced rope hems and rust proof aluminium eyelets
- Heavy duty (110gsm) tear proof tarpaulin available with rubber reinforced corners

UV PROTECTED  
WATERPROOF  
SHRINKPROOF  
ROTPROOF



Code	Colour	Thickness (gsm)	Size (m)	Pack Qty
RYTA080027035	BLUE	80	2.7 x 3.5	1
RYTA080035054		80	3.5 x 5.4	1
RYTA080054070		80	5.4 x 7.0	1
RYTA110035054		110	3.5 x 5.4	1

### GLAZING PACKERS

#### CORE USE

- Designed for aligning and levelling double-glazed sealed units

#### MATERIAL

- Rot proof plastic

#### MIXED PACK

- 25 x Green
- 15 x Black
- 15 x White
- 15 x Grey
- 15 x Blue
- 15 x Red

#### MIXED TUB

- 75 x Green
- 45 x Black
- 45 x White
- 45 x Grey
- 45 x Blue
- 45 x Red

AVAILABLE IN MIXED PACKS OR TUBS OF 6 THICKNESSES AS WELL AS IN SINGLE PACKS OF ONE THICKNESS

PLASTIC & COLOUR CODED



Code	Colour	Size (mm)	Thickness (mm)	Pack Qty	Outer Qty
RPSG102801	GREEN	28 x 100	1	1000	-
RPSG102802	BLACK	28 x 100	2	1000	-
RPSG102803	WHITE	28 x 100	3	1000	-
RPSG102804	GREY	28 x 100	4	1000	-
RPSG102805	BLUE	28 x 100	5	1000	-
RPSG102806	RED	28 x 100	6	1000	-
RPSGP28100	MIXED PACK	28 x 100	1 - 6	100	10
RPSGT28100	MIXED TUB	28 x 100	1 - 6	300	1

### SOLID BRAIDED POLISHED COTTON SASH CORD

#### CORE USE

- To fit or repair traditional sash windows
- Excellent over pulleys

#### MATERIAL

- Cotton core for flexibility
- Exhibits good abrasion resistance due to the solid braided construction

ROUND CROSS SECTION  
SMOOTH POLISHED SURFACE



Code	Colour	Type	Hank Length (m)	Diameter (mm)	Breaking Strain (kg)	Pack Qty
RCRS08	RED SPOT	No 8	12.5	6	85	8
RCSB08	NATURAL	No 8	12.5	6	85	8

### WAXED COTTON SASH CORD

#### CORE USE

- To fit or repair traditional sash windows
- Efficient over pulleys

#### MATERIAL

- Made from traditional 16 plait waxed cotton
- The wax finish provides a durable, smooth running and weatherproof cord

HIGH STRENGTH DUE TO  
ITS POLYCORE  
LOW STRETCH



Code	Colour	Type	Hank Length (m)	Diameter (mm)	Breaking Strain (kg)	Pack Qty
RCW3	NATURAL	No 3	10	5	310	10
RCW4		No 4	10	6	340	10

### SNAP WEDGES

#### CORE USE

- For easy levelling and packing
- Snaps both ways for easy shimming

#### MATERIAL

- Rot proof plastic

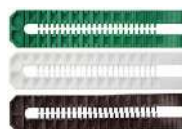

3 COLOURS - ALL ONE SIZE - THICKNESS 1 > 10MM

Code	Colour	Size (mm)	Pack Type	Pack Qty	Outer Qty
RPSST042200	MIXED TUB	200 x 42	Tub	50	1

### FRAME PACKERS

#### CORE USE

- Ideal for packing out framework, aligning kitchen units and window frames

#### MATERIAL

- Rot proof plastic

#### MIXED PACK

- 25 x Yellow
- 15 x Green
- 15 x Blue
- 15 x Red
- 15 x Brown
- 15 x Black

#### MIXED TUB

- 75 x Yellow
- 45 x Green
- 45 x Blue
- 45 x Red
- 45 x Brown
- 45 x Black

AVAILABLE IN MIXED PACKS OR TUBS OF 6 THICKNESSES AS WELL AS IN SINGLE PACKS OF ONE THICKNESS

PLASTIC & COLOUR CODED

HORSESHOE SHAPE  
ALLOWS THE PACKER TO BE HUNG OVER THE FIXING WHILST ADJUSTMENTS ARE MADE

WEDGE SHAPED TIPS  
FOR EASY INSERTION INTO GAPS



Code	Colour	Size (mm)	Thickness (mm)	Pack Qty	Outer Qty
RPSF04505501	YELLOW	45 x 55	1	1000	-
RPSF04505502	GREEN	45 x 55	2	1000	-
RPSF04505503	BLUE	45 x 55	3	1000	-
RPSF04505504	RED	45 x 55	4	1000	-
RPSF04505505	BROWN	45 x 55	5	1000	-
RPSF04505506	BLACK	45 x 55	6	1000	-
RPSFP045055	MIXED PACK	45 x 55	1 - 6	100	10
RPSFT045055	MIXED TUB	45 x 55	1 - 6	300	1

### WEDGE PACKERS

#### CORE USE

- Allows adjustment for levelling and aligning various building components
- They can be nailed through for final fixing

INTERLOCKING RIBBED SURFACES  
FOR EASY INCREMENTAL ADJUSTMENT & GOOD GRIP TO PREVENT SLIPPING

USE IN PAIRS TO GIVE FULL ADJUSTABILITY



Code	Colour	Size (mm)	Pack Type	Pack Qty	Outer Qty
RPSWP045080G	GREEN	45 x 80	Bag	10	10
RPSWT045080G		45 x 80	Tub	50	1



## HELICAL THREAD COMPOSITE PANEL FIXINGS

### CORE USE

- Used for securing structural plywood composite insulation boards (6mm) to flat roofs
- Improved design to prevent bending

### MATERIAL

- Bright zinc plated

HEAD 20MM DIAMETER FOR EASY HAMMERING  
THREAD ROTATES WHILST BEING DRIVEN IN



### BOXES

Code	Suitable for Panels (mm)	Size (mm)	Box Qty
RPHTHGB08090	Up to 55	8 x 90	500
RPHTHGB08135	70-96	8 x 135	500
RPHTHGB08165	96-126	8 x 165	500
RPHTHGB08195	126-156	8 x 195	300
RPHTHGB08220	156-185	8 x 220	300

### BAGS

Code	Suitable for Panels (mm)	Size (mm)	Bag Qty
RPHTHGP08090	Up to 55	8 x 90	25
RPHTHGP08135	70-96	8 x 135	25
RPHTHGP08165	96-126	8 x 165	25
RPHTHGP08195	126-156	8 x 195	25
RPHTHGP08220	156-185	8 x 220	25

## SLATE HOOKS

### CORE USE

- Used for repair, slip it under the slate and hook or drive it in place without having to remove any other slates

### MATERIAL

- Blackened A4 Stainless Steel for ultimate corrosion resistance
- These hooks can be used in marine environments to ensure roof longevity



Code	Material	Type	Grade	Size (mm)	Pack Qty
RSHXP080	BLACKENED STAINLESS STEEL	Point Driven	316/A4	80	500
RSHXP100		Point Driven	316/A4	100	500
RSHXP110		Point Driven	316/A4	110	500
RSHXP120		Point Driven	316/A4	120	500
RSHXP130		Point Driven	316/A4	130	500
RSHXP150		Point Driven	316/A4	150	500

## RIDGE NAIL & SCREW SETS

### CORE USE

- Used to fix ridge tiles
- The neoprene washer provides a seal, the foam protects the ridge from the seal and the nail/screw head

### MATERIAL

- A2 Stainless Steel for ultimate corrosion resistant

MAINTENANCE FREE

A2

### COMPLETE WITH FOAM AND WASHERS



Code	Material	Description	Size (mm)	Bag Qty
RPRN100	STAINLESS STEEL	Ridge Nail Set	100 x 3.75	7
RPRS100		Ridge Screw Set	100 x 4.00	100
RPRSCLA050025		Ridge Angled Clamp Plate	50 x 25	100
RPRSCLS050030		Ridge Straight Clamp Plate	50 x 30	100
RPRS100CLA		Screw Set w/Angled Plate	100 x 4.00	100
RPRS100CLS		Screw Set w/Straight Plate	100 x 4.00	100

## SLATE STRAPS

### CORE USE

- For slate repairs
- The strips are fixed into the batten and then turned up at the end to hold the repaired slate into place

### MATERIAL

- Aluminium or copper for a long life and ultimate corrosion resistance

PREDRILLED AT ONE END



Code	Material	Length (mm)	Pack Qty
RRSC150	COPPER	150	100
RRSA127	ALUMINIUM	127	100
RRSA150		150	100

## COPPER DISC RIVETS

### CORE USE

- Used in the fixing of the slates to combat 'wind lift' and allow slates to bend and recover under wetting and heating cycles

### MATERIAL

- Copper for a long life and ultimate corrosion resistance

AVAILABLE PREPACKED IN OUR NAILS SECTION



Code	Material	Head Dia. (mm)	Shaft Size (mm)	Pack Qty
RRDC	COPPER	19-20	18.5-20 x 2	1000

## VERGE CLIPS

### CORE USE

- Used to securely fix interlocking tiles

### MATERIAL

- Aluminium for a long life and ultimate corrosion resistance

PREDRILLED HOLES  
2 x 5MM DIAMETER

THICKNESS  
1.5MM



SCREWS NOT INCLUDED

Code	Material	Length (mm)	Width (mm)	Upright (mm)	Return (mm)	Bag Qty
RVCUA055052200	ALUMINIUM	170	19	60/55	30/25	100

## UPVC HINGED WASHERS & ROOF FITTING SETS

### CORE USE

- Hinged clear roofing washers are ideal for use with bolts or screws on plastic roof sheeting
- The cover protects the head of the screw or bolt and ensures the fixing is watertight
- Washer available with a bright zinc plated round head industry standard cross recessed screw ready for use
- Also available with 18mm spacer to fill the area between the crown of the corrugated roof and the timber purlin

### MATERIAL

- Washer and spacer moulded from flexible UV stabilised PVC

HINGED ROOFING WASHER

WASHER & SCREW ROOF FITTING SET

WASHER, SCREW & SPACER ROOF FITTING SET

Code	Description	Spacer (mm)	Washer Size (mm)	Screw Size	Bag Qty
RPFW	uPVC Hinged Washer	-	M6 x 20	-	100
RPFS	Washer & Screw Set	-	M6 x 20	8 x 2"	10
RPFSSP	Washer, Screw & Spacer Set	18	M6 x 20	8 x 2"	10



## LEAD DOME SETS

Also known as "lead dots".

### CORE USE

- Often used for vertical cladding

1X LEAD DOME  
1X SOLID BRASS RECESS PATTERN SCREW CUP  
1X SLOTTED CSK BRASS SCREW  
1X NYLON WASHER



Code	Finish	Screw Size	Bag Qty	Outer Qty
RLDS020	LEAD & BRASS	8 x 1/4"	20	1 Bag

## LEAD FLASHING FIXING CLIPS

### CORE USE

- Grips lead firmly in place allowing the flashing to be dressed before pointing to give you a professional finish

ONE BAG OF 50 CLIPS FIXES UP TO 20 LINEAR METRES OF LEAD FLASHING

A2



Code	Material	Size	Bag Qty	Outer Qty
RLHC050	STAINLESS STEEL	For lead chases 6-18mm	50	10 Bags

## WIRE BALLOONS

### CORE USE

- Keeps soil stack and rainwater downpipes clear of leaves and soil
- Stops birds from nesting on and in chimneys



Code	Finish	Size	Pack Qty
RBWP065	GREY PVC	2 1/2"	5
RBWP075		3"	5
RBWP100		4"	5
RBWP150		6"	1
RBWP200		8"	1
RBWP225		9"	1
RBWG065	GALVANISED	2 1/2"	10
RBWG075		3"	10
RBWG100		4"	10
RBWG150		6"	10
RBWG200		8"	10
RBWG225		9"	10

## SNOWGUARDS & BRACKETS

### CORE USE

- Used to stop snow or debris from sliding from roof or conservatory (fixed to fascia board)
- Panels can be fixed to brackets using galvanised tying wire or cable ties
- It is recommended to use a bracket for every 1m of snowguard panel



Round gutter fits snowguard in front of gutter  
Over gutter fits snowguard behind gutter  
V-shaped gutter fits to the top end of the rafter

Code	Finish	Type	Size	Pack Qty
RSNG06	GALVANISED	Snowguard Panel	6" x 2M Length	1
RSNG09		Snowguard Panel	9" x 2M Length	1
RSNG06B		Round Gutter Bracket	To Suit 6" Panel	1
RSNG09B		Round Gutter Bracket	To Suit 9" Panel	1
RSNG06OG		Over Gutter Bracket	To Suit 6" Panel	1
RSNG09OG		Over Gutter Bracket	To Suit 9" Panel	1
RSNG06V		V-Shaped Bracket	To Suit 6" Panel	1
RSNG09V		V-Shaped Bracket	To Suit 9" Panel	1

## HIP IRONS

### CORE USE

- Screwed to rafter and embedded in mortar at base of hip to prevent ridge tiles from slipping off

### MATERIAL

- Galvanised decorative scroll pattern

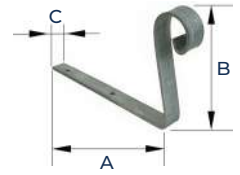

\* The final dimension is the thickness of the material

Code	Finish	Description	Size (mm)	Pack Qty
RHIG3		Baby	205 (A) x 125 (B) x 25 (C) x 3*	1
RHIG4	GALVANISED	Standard	270 (A) x 150 (B) x 25 (C) x 4*	1
RHIG5		Large	270 (A) x 150 (B) x 25 (C) x 5*	1

## EPDM LEAD REPLACEMENT

### CORE USE

- Suitable for a wide range of roofing applications

### MATERIAL

- A very effective self adhesive lead substitute made from EPDM and aluminium

UV RESISTANT  
LIGHTWEIGHT  
NON TOXIC  
DURABLE  
FLEXIBLE



Code	Finish	Width (mm)	Length (m)	Pack Qty
REPDMBL05300	BLACK	300	5	1
REPDMG05300	GREY	300	5	1

## SOAKERS

### CORE USE

- Suitable for slate and tiled roofs
- Placed in between each line of tiles or slates in order to enhance durability and minimise the risk of leaks
- Cost effective alternative to lead flashing

### INSTALLATION

- Insert the soakers between successive courses to make the joint waterproof
- Nail each soaker to the battens and dress down the roof slope with its bottom edge covered by the slate above

### MATERIAL

- Aluminium for a long life

LONG LASTING  
EASY TO USE  
PRE-FORMED WITH  
A 90° ANGLE



Code	Material	Size (mm)	Pack Qty
RSAB050100150	ALUMINIUM	50 x 100 x 150	25
RSAB050100300		50 x 100 x 300	25
RSAB050100340		50 x 100 x 340	25
RSAB075075150		75 x 75 x 150	25
RSAB075075300		75 x 75 x 300	25
RSAB075075340		75 x 75 x 340	25
RSAB075100150		75 x 100 x 150	25
RSAB075100180		75 x 100 x 180	25
RSAB075100300		75 x 100 x 300	25
RSAB075100340		75 x 100 x 340	25
RSAB075100375		75 x 100 x 375	25
RSAB075100400		75 x 100 x 400	25

## SOFT COPPER WIRE

### CORE USE

- Can be arranged on a roof to keep the moss in check without ruining look of the roof

### MATERIAL

- Copper minimises the effects of corrosion



Code	Material	Size (mm)	Pack Qty
RWC005200	COPPER	2.00 (500g approx. 17m)	1

## BUTT HINGES

### 551 BUTT HINGE | STAINLESS STEEL

#### CORE USE

- Rectangular high quality door hinge
- Two ball bearing fixed pin hinge with square corners

#### MATERIAL

- Satin or polished stainless steel for ultimate corrosion resistance
- Electro brassed for everyday use

MANUFACTURED TO  
BS EN 1935 GRADE 13  
(4" ONLY)



UK  
CA

COMPLETE WITH FIXING SCREWS  
4" CAN BE USED ON FIRE & SMOKE DOORS  
CERTIFICATES AVAILABLE ON REQUEST

Code	Finish	Size	Size (mm)	Open Width (mm)	Pairs Per Box
HH51SSS300	SATIN	3" x 2"	75	50	1
HH51SSS400	STAINLESS STEEL	4" x 3"	100	75	1
HH51PSS300	POLISHED	3" x 2"	75	50	1
HH51PSS400	STAINLESS STEEL	4" x 3"	100	75	1
HH51E300	ELECTRO BRASS	3" x 2"	75	50	1
HH51E400		4" x 3"	100	75	1

### 451 BUTT HINGE | STRONG

#### CORE USE

- A heavy duty cranked butt hinge for use on internal and domestic doors
- Alternative to the 1838 Butt Hinge



\*\* ALSO AVAILABLE PREPACKED

Code	Finish	Size	Size (mm)	Open Width (mm)	Screw Holes/Pair	Screw Gauge	Pairs Per Box
HH451S300	SELF COLOUR	3" x 2 1/2"	75	63	12	10	10
HH451S400		4" x 3"	100	75	16	10	5
HH451Z300	BZP**	3" x 2 1/2"	75	63	12	10	10
HH451Z400		4" x 3"	100	75	16	10	5
HH451E300	ELECTRO BRASS	3" x 2 1/2"	75	63	12	10	10
HH451E400		4" x 3"	100	75	16	10	5
HH451B300	EPOXY BLACK	3" x 2 1/2"	75	63	12	10	10
HH451B400		4" x 3"	100	75	16	10	5

### 1838 BUTT HINGE | LIGHT

#### CORE USE

- Our most popular butt hinge
- A standard, light duty cranked butt hinge with a fixed pin for general use on internal and domestic doors



\* COMPLETE WITH FIXING SCREWS  
\*\* ALSO AVAILABLE PREPACKED

Code	Finish	Size	Size (mm)	Open Width (mm)	Screw Holes/Pair	Screw Gauge	Pairs Per Box
HH1838S100	SELF COLOUR	1" x 1"	25	25	8	4	25
HH1838S150		1 1/2" x 1 1/4"	38	32	8	6	10
HH1838S200		2" x 1 1/2"	50	38	8	6	10
HH1838S250		2 1/2" x 1 3/4"	63	45	12	6	10
HH1838S300		3" x 2"	75	50	12	7	10
HH1838S350		3 1/2" x 2 1/4"	90	55	12	7	10
HH1838S400		4" x 3"	100	75	16	8	5
HH1838Z100	BZP**	1" x 1"	25	25	8	4	25
HH1838Z150		1 1/2" x 1 1/4"	38	32	8	6	10
HH1838Z200		2" x 1 1/2"	50	38	8	6	10
HH1838Z250		2 1/2" x 1 3/4"	63	45	12	6	10
HH1838Z300		3" x 2"	75	50	12	7	10
HH1838Z350		3 1/2" x 2 1/4"	90	55	12	7	10
HH1838Z400		4" x 3"	100	75	16	8	5
HH1838CP300	POLISHED CHROME*	3" x 2"	75	50	12	7	10
HH1838CP400		4" x 3"	100	75	16	8	5
HH1838SNP300	SATIN NICKEL*	3" x 2"	75	50	12	7	10
HH1838SNP400		4" x 3"	100	75	16	8	5
HH1838E100	ELECTRO BRASS	1" x 1"	25	25	8	4	25
HH1838E150		1 1/2" x 1 1/4"	38	32	8	6	10
HH1838E200		2" x 1 1/2"	50	38	8	6	10
HH1838E250		2 1/2" x 1 3/4"	63	45	12	6	10
HH1838E300		3" x 2"	75	50	12	7	10
HH1838E400		4" x 3"	100	75	16	8	5
HH1838ST300		STAINLESS STEEL	3" x 2"	75	50	12	7
HH1838ST400	4" x 3"		100	75	16	8	5
HH1838B300	EPOXY BLACK*	3" x 2"	75	50	12	7	10
HH1838B400		4" x 3"	100	75	16	8	5

### 451/S BUTT HINGE | HIGH SECURITY

#### CORE USE

- Ideal for public areas
- Strong with cranked knuckles, fixed riveted steel pin and integral pressed double security lugs to help stop the door being removed



Code	Finish	Size	Size (mm)	Open Width (mm)	Screw Holes/Pair	Screw Gauge	Pairs Per Box
HH451SECS400	SELF COLOUR	4" x 3"	100	75	16	10	5
HH451SECCZ400	BZP	4" x 3"	100	75	16	10	5

### 899 BUTT HINGE | EXTRA STRONG

#### CORE USE

- Used extensively in local authority work
- Suitable for use on standard internal doors

#### MATERIAL

- Double pressed for extra strength
- Economical, very heavy duty

CENTRAL PIVOT PIN  
ABLE TO TAKE  
EXTRA WEIGHT



Code	Finish	Size	Size (mm)	Open Width (mm)	Screw Holes/Pair	Screw Gauge	Pairs Per Box
HH899S300	SELF COLOUR	3" x 2 1/2"	75	63	12	8	10
HH899S400		4" x 3"	100	75	16	10	5
HH899S600		6" x 4"	150	100	16	10	2

### 1840 BUTT HINGE | LOOSE PIN

#### CORE USE

- Cranked light steel hinge with a loose pin
- The ability to remove the pin allows easy removal of doors and re-installation



\* COMES COMPLETE WITH FIXING SCREWS

Code	Finish	Size	Size (mm)	Open Width (mm)	Screw Holes/Pair	Screw Gauge	Pairs Per Box
HH1840S300	SELF COLOUR	3" x 2"	75	50	12	7	10
HH1840S400		4" x 3"	100	75	16	8	5
HH1840Z300	BZP	3" x 2"	75	50	12	7	10
HH1840Z400		4" x 3"	100	75	16	8	5
HH1840CP300	POLISHED CHROME*	3" x 2"	75	50	12	7	10
HH1840CP400		4" x 3"	100	75	16	8	5
HH1840E300	ELECTRO BRASS	3" x 2"	75	50	12	7	10
HH1840E400		4" x 3"	100	75	16	8	5

### 457 BUTT HINGE | LIFT OFF

#### CORE USE

- For easy removal of the door



HANDED PRODUCT

#### LEFT HAND

Code	Finish	Size	Size (mm)	Open Width (mm)	Screw Holes Per Pair	Screw Gauge	Pairs Per Box
HH457S300L	SELF COLOUR	3" x 3"	75	75	12	10	10
HH457S400L		4" x 4"	100	100	16	10	5

#### RIGHT HAND

Code	Finish	Size	Size (mm)	Open Width (mm)	Screw Holes Per Pair	Screw Gauge	Pairs Per Box
HH457S300R	SELF COLOUR	3" x 3"	75	75	12	10	10
HH457S400R		4" x 4"	100	100	16	10	5

### 200 BUTT HINGE | CAST IRON

#### CORE USE

- A very traditional hinge used extensively as direct replacements for older patterns of hinges



Code	Finish	Size	Size (mm)	Open Width (mm)	Screw Holes/Pair	Screw Gauge	Pairs Per Box
HH200S250	SELF COLOUR	2 1/2" x 2"	63	50	12	8	5
HH200S300		3" x 2"	75	50	12	8	5
HH200S400		4" x 2 1/2"	100	63	16	8	5

### 466 BUTT HINGE | RISING

#### CORE USE

- Aids self-closing of the door and lift the opening door clear of an uneven floor surface



HANDED PRODUCT

#### LEFT HAND

Code	Finish	Size	Size (mm)	Open Width (mm)	Screw Holes Per Pair	Screw Gauge	Pairs Per Box
HH466S300L	SELF COLOUR	3" x 2 3/4"	75	70	12	7	5
HH466S400L		4" x 3"	100	75	16	10	5
HH466Z300L	BZP	3" x 2 3/4"	75	70	12	7	5
HH466Z400L		4" x 3"	100	75	16	10	5
HH466E300L	ELECTRO BRASSED	3" x 2 3/4"	75	70	12	7	5
HH466E400L		4" x 3"	100	75	16	10	5

#### RIGHT HAND

Code	Finish	Size	Size (mm)	Open Width (mm)	Screw Holes Per Pair	Screw Gauge	Pairs Per Box
HH466S300R	SELF COLOUR	3" x 2 3/4"	75	70	12	7	5
HH466S400R		4" x 3"	100	75	16	10	5
HH466Z300R	BZP	3" x 2 3/4"	75	70	12	7	5
HH466Z400R		4" x 3"	100	75	16	10	5
HH466E300R	ELECTRO BRASSED	3" x 2 3/4"	75	70	12	7	5
HH466E400R		4" x 3"	100	75	16	10	5

**Butt hinges** are the most commonly used hinge, usually constructed of two matching leaves connected by a joint traditionally holding a pin.

One leaf is fixed to the door, the other to the door jamb. They are usually **recessed in and sit flush** when installed.

For handed products - state hand when ordering.

Our **Butt Hinges** are sold in pairs and some are available with fixings included.

**1838 and 451 Butt Hinges** are also available in our prepacked GatePro Ironmongery section.

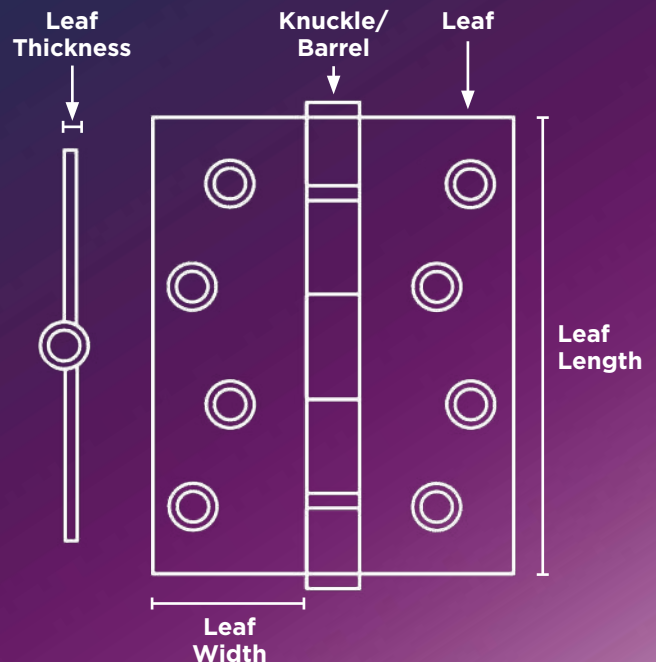



## SPECIALIST HINGES

### 104 HURLINGE

#### CORE USE

- Used mostly in cabinet fitting
- Enables doors to be hung with no morticing of the door or frame
- Self locating for ease of fitting



Code	Finish	Size	Size (mm)	Screw Holes/Pair	Screw Gauge	Pairs Per Box
HH104S200	SELF COLOUR	2"	50	8	4	25
HH104S250		2 1/2"	63	10	4	25
HH104S300		3"	75	12	6	25
HH104S400		4"	100	12	8	10
HH104Z200	BZP	2"	50	8	4	25
HH104Z250		2 1/2"	63	10	4	25
HH104Z300		3"	75	12	6	25
HH104Z400		4"	100	12	8	10
HH104E200	ELECTRO BRASS	2"	50	8	4	25
HH104E250		2 1/2"	63	10	4	25
HH104E300		3"	75	12	6	25
HH104E400		4"	100	12	8	10

### 105 FLUSH HINGE

#### CORE USE

- No-mortice butt hinge used primarily on light doors and cabinets
- Fitted with a fixed pin



Code	Finish	Size	Size (mm)	Screw Holes/Pair	Screw Gauge	Pairs Per Box
HH105S040	SELF COLOUR	1 1/2"	38	8	4	25
HH105S050		2"	50	8	4	25
HH105S060		2 1/2"	63	8	4	25
HH105S075		3"	75	8	4	25
HH105Z040	BZP	1 1/2"	38	8	4	25
HH105Z050		2"	50	8	4	25
HH105Z060		2 1/2"	63	8	4	25
HH105Z075		3"	75	8	4	25
HH105E040	ELECTRO BRASS	1 1/2"	38	8	4	25
HH105E050		2"	50	8	4	25
HH105E060		2 1/2"	63	8	4	25
HH105E075		3"	75	8	4	25

### 1951 STORMPROOF HINGE

#### CORE USE

- Stormproof hinges fit neatly into the rebate of a stormproof casement window allowing any draughts to be minimised



Code	Finish	Size	Size (mm)	Screw Holes/Pair	Screw Gauge	Pairs Per Box
HH1951Z250	BZP	2 1/2"	63	12	7	10
HH1951E250	ELECTRO BRASS	2 1/2"	63	12	7	10

### 488 PARLIAMENT HINGE

#### CORE USE

- They project from the door and the frame enabling the door to open around protruding architraves

THEY ARE MEASURED:  
HEIGHT x OPEN WIDTH x INTERNAL WIDTH

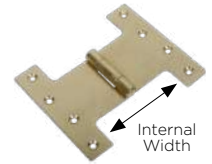

Code	Finish	Size	Internal Width (mm)	Screw Holes/Pair	Screw Gauge	Pairs Per Box
HH488S300	SELF COLOUR	4" x 4 1/2" x 3"	75	12	7	5
HH488S400	SELF COLOUR	6" x 6" x 4"	100	16	10	5
HH488Z300	BZP	4" x 4 1/2" x 3"	75	12	7	5
HH488Z400		6" x 6" x 4"	100	16	10	5
HH488E300	ELECTRO BRASS	4" x 4 1/2" x 3"	75	12	7	5
HH488E400		6" x 6" x 4"	100	16	10	5

### DOUBLE ACTION SPRING HINGE

#### CORE USE

- Allows doors to be self closing when opened both ways
- Ideal for kitchen or wash-up doors in restaurants



COMPLETE WITH ALL NECESSARY FIXINGS

Code	Finish	Size	Size (mm)	Door Weight (kg)	Door Thickness (mm)	Pairs Per Box
HH300SSS075	SATIN STAINLESS STEEL	3"	75	< 18	55-65	1
HH300SSS100		4"	100	12-26	55-65	1
HH300SSS125		5"	125	30-35	65-70	1
HH300SSS150		6"	150	35-40	70-75	1

### 400 BACKFLAP HINGE

#### CORE USE

- Commonly used in cabinet making and on garden furniture
- Cranked pattern enables the counter to be opened through 180°
- Fitted with a fixed pin



Code	Finish	Size	Size (mm)	Open Width (mm)	Screw Holes Per Pair	Screw Gauge	Pairs Per Box
HH400S075	SELF COLOUR	3/4"	19	72	8	6	25
HH400S100		1"	25	75	12	6	25
HH400S125		1 1/4"	32	82	12	6	10
HH400S150		1 1/2"	38	90	12	6	10
HH400S200		2"	50	105	12	8	10
HH400S250		2 1/2"	63	150	12	10	10
HH400S300		3"	75	165	12	10	5

### 101 PIANO HINGE

#### CORE USE

- Used where constant support along the length of the door or panel is needed

#### MATERIAL

- Steel hinge for strength with a decorative finish



Code	Finish	Size	Length (mm)	Open Width (mm)	Screw Holes/Each	Screw Gauge	Box Qty
HH101E025	ELECTRO BRASS	6' x 1"	1800	25	62	3	10
HH101E032		6' x 1 1/4"	1800	32	62	3	10
HH101N025	NICKEL PLATED	6' x 1"	1800	25	62	3	10
HH101N032		6' x 1 1/4"	1800	32	62	3	10



### 416 BRASS BUTT HINGE

#### CORE USE

- Used primarily in furniture and joinery applications

#### MATERIAL

- Solid drawn brass butt hinge with brass pin



Code	Finish	Size	Size (mm)	Open Width (mm)	Screw Holes/Pair	Screw Gauge	Pairs Per Box
HH416S15	SELF COLOUR	1 1/2" x 7/8"	38	22	12	4	10
HH416S20		2" x 1 1/8"	50	28	12	4	10
HH416S25		2 1/2" x 1 3/8"	63	35	12	6	10
HH416S30		3" x 1 5/8"	75	41	12	8	10
HH416S40		4" x 2 5/8"	100	60	16	10	5

### 417 DSW BRASS BUTT HINGE

#### CORE USE

- Double steel washers provide added strength and durability, avoiding premature wear when used on heavy doors

#### MATERIAL

- Solid drawn brass butt hinge with steel pin and double steel washers (DSW)



Code	Finish	Size	Size (mm)	Open Width (mm)	Screw Holes/Pair	Screw Gauge	Pairs Per Box
HH417S30	SELF COLOUR	3" x 2"	75	50	16	10	10
HH417S40		4" x 2 5/8"	100	67	16	12	5

### 418 DSW BRASS BUTT HINGE

#### CORE USE

- Double steel washers provide added strength and durability, avoiding premature wear when used on heavy doors

#### MATERIAL

- Solid drawn polished brass butt hinge with steel pin and double steel washers (DSW)



Code	Finish	Size	Size (mm)	Open Width (mm)	Screw Holes/Pair	Screw Gauge	Pairs Per Box
HH418P30	POLISHED	3" x 2"	75	50	16	10	10
HH418P40		4" x 2 5/8"	100	67	16	12	5

### 499C CUPS FOR HEAVY REVERSIBLE HINGES

#### CORE USE

- For use with 499 Heavy Reversible Hinges

#### MATERIAL

- Cast iron cups



Code	Finish	Size	Size (mm)	Screw Holes/Pair	Pairs Per Box
HH499ZCG12	GALVANISED	1/2"	13	8	1
HH499ZCG16		5/8"	16	8	1
HH499ZCG20		3/4"	19	8	1
HH499ZCB12	EPOXY BLACK	1/2"	13	8	1
HH499ZCS16		5/8"	16	8	1
HH499ZCS20		3/4"	19	8	1

**Solid drawn** and **polished brass** hinges.

Very attractive hinges which are **anti-corrosive**, work within a wide temperature range and are **water resistant**.

**Solid drawn** means the hinges have been created from a section of brass which has been pulled and stretched into shape. This gives a **smooth, strong finish**.

### 1951 BRASS STORMPROOF HINGE

#### CORE USE

- Fits neatly into the rebate of a casement window allowing any draughts to be minimised

#### MATERIAL

- Solid brass and self colour



Code	Finish	Size	Size (mm)	Screw Holes/Pair	Screw Gauge	Pairs Per Box
HH1951BS250	SELF COLOUR	2 1/2"	63	12	8	10

### 488 BRASS PARLIAMENT HINGE

#### CORE USE

- Polished hinge which projects from the door and the frame enabling the door to open around protruding architraves

THEY ARE MEASURED:  
HEIGHT x OPEN WIDTH x INTERNAL WIDTH



Code	Finish	Size	Internal Width (mm)	Screw Holes/Pair	Screw Gauge	Pairs Per Box
HH488B944	POLISHED	4" x 4" x 2"	50	16	10	5

### 499 HEAVY REVERSIBLE HINGE

#### CORE USE

- Used on stable doors or garage doors
- Provide more security than a hook & band as the hinge cannot be lifted off

#### MATERIAL

- Steel band with cast iron cups



Code	Finish	Size	Size (mm)	Screw Holes/Pair	Pin Size	Pairs Per Box
HH499G12	GALVANISED	12"	300	20	1/2"	2
HH499G14		14"	350	20	1/2"	2
HH499G16		16"	400	22	1/2"	2
HH499G18		18"	450	22	5/8"	1
HH499G20		20"	500	22	5/8"	1
HH499G24		24"	600	22	5/8"	1
HH499G30		30"	750	24	3/4"	1
HH499G36		36"	900	24	3/4"	1
HH499G48		48"	1200	24	3/4"	1
HH499B12		EPOXY BLACK	12"	300	20	1/2"
HH499B14	14"		350	20	1/2"	2
HH499B16	16"		400	22	1/2"	2
HH499B18	18"		450	22	5/8"	1
HH499B20	20"		500	22	5/8"	1
HH499B24	24"		600	22	5/8"	1
HH499B30	30"		750	24	3/4"	1
HH499B36	36"		900	24	3/4"	1
HH499B48	48"		1200	24	3/4"	1

## TEE & STRAP HINGES

**Tee hinges** are commonly used for outside doors and are **ideal for sheds and barns**. The rectangular leaf attaches to the frame or post and the long tapered strap to the door or gate.

### 121A LIGHT TEE HINGE

#### CORE USE

- For light duty use on animal hutches and light gates



Code	Finish	Size	Size (mm)	Screw Holes/Pair	Screw Gauge	Pairs Per Box
HH121AB040	EPOXY BLACK	4"	100	12	6	10
HH121AB060		6"	150	12	6	10
HH121AB080		8"	200	14	8	10
HH121AB090		9"	230	14	8	10
HH121AB100		10"	250	14	8	10
HH121AB120		12"	300	14	8	10
HH121AZ040	BZP	4"	100	12	6	10
HH121AZ060		6"	150	12	6	10
HH121AZ080		8"	200	14	8	10
HH121AZ090		9"	230	14	8	10
HH121AZ100		10"	250	14	8	10
HH121AZ120		12"	300	14	8	10

### 121 MEDIUM TEE HINGE

#### CORE USE

- For heavier duty use on sheds and garden gates



Code	Finish	Size	Size (mm)	Screw Holes/Pair	Screw Gauge	Pairs Per Box
HH121G120	GALVANISED	12"	300	16	8	5
HH121G140		14"	350	18	8	5
HH121G150		15"	375	18	10	5
HH121G160		16"	400	18	10	5
HH121G180		18"	450	18	10	5
HH121G200		20"	500	18	12	5
HH121G240		24"	600	18	14	5
HH121B120	EPOXY BLACK	12"	300	16	8	5
HH121B140		14"	350	18	8	5
HH121B150		15"	375	18	10	5
HH121B160		16"	400	18	10	5
HH121B180		18"	450	18	10	5
HH121B200		20"	500	18	12	5
HH121B240	BZP	24"	600	18	14	5
HH121Z120		12"	300	16	8	5
HH121Z140		14"	350	18	8	5
HH121Z150		15"	375	18	10	5
HH121Z160		16"	400	18	10	5
HH121Z180		18"	450	18	10	5
HH121Z200		20"	500	18	12	5
HH121Z240		24"	600	18	14	5

### 868 WEIGHTY SCOTCH TEE HINGE

#### CORE USE

- A very heavy duty gate hinge with maximum corrosion prevention



Code	Finish	Size	Size (mm)	Screw Holes/Pair	Screw Gauge	Pairs Per Box
HH868G040	GALVANISED	4"	100	12	6	5
HH868G060		6"	150	12	6	5
HH868G080		8"	200	14	8	5
HH868G120		12"	300	14	8	5
HH868G140		14"	350	18	8	5
HH868G150		15"	375	18	8	5
HH868G160		16"	400	18	10	2
HH868G180		18"	450	18	10	2
HH868G240	24"	600	18	12	2	

### 950 STRAP HINGE

#### CORE USE

- Commonly used on "lift up" lids on chests



Code	Finish	Size	Size (mm)	Screw Holes/Pair	Screw Gauge	Pairs Per Box
HH950Z040	BZP	4"	100	12	6	10
HH950Z060		6"	150	16	8	10
HH950Z080		8"	200	16	8	10
HH950Z100		10"	250	16	10	5
HH950Z120		12"	300	20	10	5

### 910 TEE HINGE BRASS PIN

#### CORE USE

- Ideal for medium duty use in coastal areas
- The brass pin prevents corrosion of the knuckle



Code	Finish	Size	Size (mm)	Screw Holes/Pair	Screw Gauge	Pairs Per Box
HH910ZBP120	BZP	12"	300	14	8	10
HH910ZBP150		15"	375	18	8	10
HH910ZBP180		18"	450	18	10	10

### 910 HEAVY TEE HINGE

#### CORE USE

- Ideal for medium duty use
- Standard steel pin



Code	Finish	Size	Size (mm)	Screw Holes/Pair	Screw Gauge	Pairs Per Box
HH910Z060	BZP	6"	150	12	6	5
HH910Z080		8"	200	14	8	5
HH910Z100		10"	250	14	8	5
HH910Z120		12"	300	14	8	5
HH910Z150		15"	375	18	8	5
HH910Z180		18"	450	18	10	5
HH910Z240		24"	600	18	12	5

### HOOKS & BANDS

Strong, heavy duty fixtures for outdoor use. Ideal for hanging gates, garage doors and stable doors.

Galvanised or epoxy black finish for corrosion resistance.

#### 1056 HOOK & BAND | CRANKED

**CORE USE**

- The cranked band allows the gate or door to be flush to the post or wall

**CRANKED BAND** ALLOWS MORE FLEXIBILITY IN THE POSITIONING WHEN FITTING



**COMPRISING OF:**

HOOK FOR THE FRAME OR POST  
BAND FOR THE DOOR OR GATE

Code	Finish	Size	Size (mm)	Screw Holes/Pair	Pin Size	Pairs Per Box
HH1056G10	GALVANISED	10"	250	12	1/2"	2
HH1056G12		12"	300	12	1/2"	2
HH1056G14		14"	350	12	1/2"	2
HH1056G16		16"	400	14	1/2"	2
HH1056G18		18"	450	14	5/8"	1
HH1056G20		20"	500	14	5/8"	1
HH1056G24		24"	600	14	5/8"	1
HH1056G30		30"	750	20	3/4"	1
HH1056G36		36"	900	20	3/4"	1
HH1056G48		48"	1200	20	3/4"	1
HH1056B10	EPOXY BLACK	10"	250	12	1/2"	2
HH1056B12		12"	300	12	1/2"	2
HH1056B14		14"	350	12	1/2"	2
HH1056B16		16"	400	14	1/2"	2
HH1056B18		18"	450	14	5/8"	1
HH1056B20		20"	500	14	5/8"	1
HH1056B24		24"	600	14	5/8"	1
HH1056B30		30"	750	20	3/4"	1
HH1056B36		36"	900	20	3/4"	1
HH1056B48		48"	1200	20	3/4"	1

#### 1057 HOOK & BAND | ADJUSTABLE

**CORE USE**

- The bands can be adjusted to ensure a neutral swing with an uneven frame or post



**COMPRISING OF:**

HOOK FOR THE FRAME OR POST  
ADJUSTABLE BAND FOR THE DOOR OR GATE

Code	Finish	Size	Size (mm)	Screw Holes/Pair	Pin Size	Pairs Per Box
HH1057G12	GALVANISED	12"	300	12	3/4"	2
HH1057G18		18"	450	14	3/4"	1
HH1057G24		24"	600	14	3/4"	1
HH1057G30		30"	750	20	3/4"	1
HH1057G36		36"	900	20	3/4"	1
HH1057G48		48"	1200	20	3/4"	1
HH1057B12	EPOXY BLACK	12"	300	12	3/4"	2
HH1057B18		18"	450	14	3/4"	1
HH1057B24		24"	600	14	3/4"	1
HH1057B30		30"	750	20	3/4"	1
HH1057B36		36"	900	20	3/4"	1
HH1057B48		48"	1200	20	3/4"	1

#### 1055 HOOK & BAND | STRAIGHT

**CORE USE**

- Used on heavy domestic gates or small field gates
- They have the added feature of being "lift-off"



**COMPRISING OF:**

HOOK FOR THE FRAME OR POST  
BAND FOR THE DOOR OR GATE

Code	Finish	Size	Size (mm)	Screw Holes Per Pair	Pin Size (inch)	Pairs Per Box
HH1055G12	GALVANISED	12"	300	12	1/2"	2
HH1055G14		14"	350	12	1/2"	2
HH1055G16		16"	400	14	1/2"	2
HH1055G18		18"	450	14	5/8"	1
HH1055G20		20"	500	14	5/8"	1
HH1055G24		24"	600	14	5/8"	1
HH1055G30		30"	750	20	3/4"	1
HH1055G36		36"	900	20	3/4"	1
HH1055G48		48"	1200	20	3/4"	1
HH1055B12		EPOXY BLACK	12"	300	12	1/2"
HH1055B14	14"		350	12	1/2"	2
HH1055B16	16"		400	14	1/2"	2
HH1055B18	18"		450	14	5/8"	1
HH1055B20	20"		500	14	5/8"	1
HH1055B24	24"		600	14	5/8"	1
HH1055B30	30"		750	20	3/4"	1
HH1055B36	36"		900	20	3/4"	1
HH1055B48	48"		1200	20	3/4"	1

#### 1056H HOOK ON PLATE

**CORE USE**

- Suitable for: 1055 Straight, 1056 Cranked and 1057 Adjustable Hook & Bands



Code	Finish	Size	Size (mm)	Plate Width (inch)	Screw Holes	Screw Gauge	Box Qty
HH1056HG12	GALVANISED	1/2"	13	1 3/4"	4	12	1
HH1056HG16		5/8"	16	2"	4	14	1
HH1056HG20		3/4"	19	2 1/2"	6	16	1
HH1056HB12	EPOXY BLACK	1/2"	13	1 3/4"	4	12	1
HH1056HB16		5/8"	16	2"	4	14	1
HH1056HB20		3/4"	19	2 1/2"	6	16	1

#### 1058 CURVED HINGE RAIL SET

**CORE USE**

- Ideal for gates with a curved top rail
- Being a handed hinge, you will need to select either right handed or left handed
- The hand of the hinge is determined by looking at the hinges on whichever side of the gate you choose to place them

LEFT HANDED PRODUCT SHOWN



**COMPRISING OF:**

1 x UPPER HINGE  
1 x LOWER HINGE  
2 x HOOKS ON PLATES

Code	Finish	Type	Size	Size (mm)	Box Qty
HH1058GL	GALVANISED	Left hand	12"	300	1
HH1058GR		Right hand	12"	300	1
HH1058BL	EPOXY BLACK	Left hand	12"	300	1
HH1058BR		Right hand	12"	300	1

## BOLTS



### 923A STRAIGHT TOWER BOLT

#### CORE USE

- A general purpose heavy duty bolt
- Fitted with an enclosed shoot
- Used for securing flush fitting gates and doors in a closed position



FINISH REFERS TO RETAINER PLATES

Code	Finish	Size	Size (mm)	Screw Holes	Screw Gauge	Box Qty
HD923AB030	EPOXY BLACK	3"	75	6	8	10
HD923AB040		4"	100	8	8	10
HD923AB060		6"	150	8	8	10
HD923AB080		8"	200	10	8	10
HD923AB100		10"	250	10	10	10
HD923AB120	BZP	12"	300	12	10	10
HD923AZ030		3"	75	6	8	10
HD923AZ040		4"	100	8	8	10
HD923AZ060		6"	150	8	8	10
HD923AZ080		8"	200	10	8	10
HD923AZ100	10"	250	10	10	10	
HD923AZ120	12"	300	12	10	10	
HD923AG040	GALVANISED	4"	100	8	8	10
HD923AG060		6"	150	8	8	10
HD923AG080		8"	200	10	8	10
HD923AG100		10"	250	10	10	10
HD923AG120	12"	300	12	10	10	

### 923N NECKED TOWER BOLT

#### CORE USE

- Cranked sliding bolt that is commonly used on doors with a recessed frame
- Can be fitted horizontally or vertically (downwards)

NECKED SHOOT  
ALLOWS THE DOOR  
TO BE SECURED  
DIRECTLY INTO  
THE FRAME



FINISH REFERS TO RETAINER PLATES

Code	Finish	Size	Size (mm)	Screw Holes	Screw Gauge	Box Qty
HD923NB040	EPOXY BLACK	4"	100	8	8	10
HD923NB060		6"	150	8	8	10
HD923NB080		8"	200	10	8	10
HD923NZ060	BZP	6"	150	8	8	10
HD923NG060	GALVANISED	6"	150	8	8	10

### 4A OVAL PADBOLT

#### CORE USE

- The narrow style allows it to be fixed in tighter spaces - suitable for application with width restrictions
- Often used in conjunction with a padlock



FINISH REFERS TO RETAINER PLATES

Code	Finish	Size	Size (mm)	Screw Holes	Screw Gauge	Box Qty
HD4AB450	EPOXY BLACK	4"	100	4	8	10
HD4AZ450	BZP	4"	100	4	8	10
HD4AG450	GALVANISED	4"	100	4	8	10

### 2A BRENTON PADBOLT

#### CORE USE

- A medium duty padbolt which is usually fitted to the outside of shed doors, outbuildings or garages
- It can be used in conjunction with a padlock



FINISH REFERS TO RETAINER PLATES

Code	Finish	Size	Size (mm)	Screw Holes	Screw Gauge	Box Qty
HD2AB0450	EPOXY BLACK	4" x 1/2"	100	8	8	5
HD2AB0650		6" x 1/2"	150	8	8	5
HD2AB0850		8" x 1/2"	200	8	8	5
HD2AZ0450	BZP	4" x 1/2"	100	8	8	5
HD2AZ0650		6" x 1/2"	150	8	8	5
HD2AZ0850		8" x 1/2"	200	8	8	5
HD2AZ1050		10" x 1/2"	250	8	8	5
HD2AZ1250	12" x 1/2"	300	10	8	5	
HD2AG0450	GALVANISED	4" x 1/2"	100	8	8	5
HD2AG0650		6" x 1/2"	150	8	8	5
HD2AG0850		8" x 1/2"	200	8	8	5
HD2AG1050		10" x 1/2"	250	8	8	5
HD2AG1250		12" x 1/2"	300	10	8	5

### 1A HEAVY BRENTON PADBOLT

#### CORE USE

- Provides maximum security when used in conjunction with a suitable padlock



FINISH REFERS TO RETAINER PLATES

Code	Finish	Size	Size (mm)	Screw Holes	Screw Gauge	Box Qty
HD1AB0658	EPOXY BLACK	6" x 5/8"	150	8	10	5
HD1AB0858		8" x 5/8"	200	8	10	5
HD1AB1058		10" x 5/8"	250	8	10	5
HD1AZ0658	BZP	6" x 5/8"	150	8	10	5
HD1AZ0858		8" x 5/8"	200	8	10	5
HD1AZ1058		10" x 5/8"	250	8	10	5
HD1AZ1258	12" x 5/8"	300	10	10	5	
HD1AG0658	GALVANISED	6" x 5/8"	150	8	10	5
HD1AG0858		8" x 5/8"	200	8	10	5
HD1AG1058		10" x 5/8"	250	8	10	5

### 60MT MONKEY TAIL BOLT

#### CORE USE

- A heavy duty bolt used to secure heavy doors
- Ideal for taller garage doors where an extra long handle is needed to reach the top bolt
- Can be fitted to the top or the bottom of the doors



FINISH REFERS TO RETAINER PLATE

Code	Finish	Size	Size (mm)	Screw Holes	Screw Gauge	Box Qty
HD60MTB1258	EPOXY BLACK	12" x 5/8"	300	6	8	2
HD60MTB1558		15" x 5/8"	375	6	8	2
HD60MTB1858		18" x 5/8"	450	6	8	2
HD60MTB2458		24" x 5/8"	600	6	8	2
HD60MTG1258	GALVANISED	12" x 5/8"	300	6	8	2
HD60MTG1858		18" x 5/8"	450	6	8	2
HD60MTG2458		24" x 5/8"	600	6	8	2



## 60BH BOW HANDLE BOLT

### CORE USE

- Often used with garage doors
- The bow shaped handle allows easier operation of the shoot



FINISH REFERS TO RETAINER PLATE

Code	Finish	Size	Size (mm)	Screw Holes	Screw Gauge	Box Qty
HD60BHB1258	EPOXY BLACK	12" x 5/8"	300	6	8	2
HD60BHB1858		18" x 5/8"	450	6	8	2
HD60BHB2458		24" x 5/8"	600	6	8	2
HD60BHG1258	GALVANISED	12" x 5/8"	300	6	8	2
HD60BHG1858		18" x 5/8"	450	6	8	2
HD60BHG2458		24" x 5/8"	600	6	8	2

## 68 FOOT OPERATED BOLT

### CORE USE

- Commonly used for the bottom of a garage door as a hands free method lifting or lowering the bolt



### MATERIAL

- Cast iron bolt/shoot

FINISH REFERS TO RETAINER PLATE

Code	Finish	Size	Size (mm)	Screw Holes	Screw Gauge	Box Qty
HD68B800	EPOXY BLACK	8"	200	8	10	5
HD68Z800	BZP	8"	200	8	10	5

## 66 CHAIN BOLT

### CORE USE

- Used as a simple self-latching mechanism, fitted vertically at the top of a door or gate
- With a reversible spring loaded bolt
- Receiver plate included to cover the hole required for the shoot

**BOLT SPRUNG - LOCKS AUTOMATICALLY WHEN THE DOOR IS PUSHED SHUT**



CHAIN PULLED TO RELEASE THE BOLT

FINISH REFERS TO RETAINER PLATE

Code	Finish	Size	Size (mm)	Screw Holes	Screw Gauge	Box Qty
HD66B800	EPOXY BLACK	8"	200	8	10	5
HD66Z800	BZP	8"	200	8	10	5

## 1260 GARAGE DOOR BOLT

### CORE USE

- General purpose drop bolt
- Most commonly used on garage doors and fieldgates



FINISH REFERS TO RETAINER PLATES

Code	Finish	Size	Size (mm)	Screw Holes	Screw Gauge	Box Qty
HD1260B120	EPOXY BLACK	12"	300	6	10	2
HD1260B180		18"	450	6	10	2
HD1260B240		24"	600	8	10	2
HD1260G120	GALVANISED	12"	300	6	10	2
HD1260G180		18"	450	6	10	2
HD1260G240		24"	600	8	10	2

## STRAIGHT BARREL BOLT

### CORE USE

- For securing internal doors

SUPPLIED WITH FIXING SCREWS



Code	Material	Type	Size	Size (mm)	Box Qty
HD105SS150	BRASS	Straight	1 1/2"	38	10
HD105SS200		Straight	2"	50	10
HD105SS250		Straight	2 1/2"	63	10
HD105SS300		Straight	3"	75	10
HD105SS400		Straight	4"	100	10
HD105SS600		Straight	6"	150	10
HD106SS200	ALUMINIUM	Straight	2"	50	10
HD106SS300		Straight	3"	75	10
HD106SS400		Straight	4"	100	10
HD106SS600		Straight	6"	150	10

## NECKED BARREL BOLT

### CORE USE

- For securing internal doors
- Cranked sliding bolt that is commonly used on doors with a recessed frame
- Can be fitted horizontally or vertically (downwards)



SUPPLIED WITH FIXING SCREWS

Code	Material	Type	Size	Size (mm)	Box Qty
HD105NS200	BRASS	Necked	2"	50	10
HD105NS250		Necked	2 1/2"	63	10
HD105NS300		Necked	3"	75	10
HD105NS400		Necked	4"	100	10
HD105NS600		Necked	6"	150	10
HD106NS300		ALUMINIUM	Necked	3"	75
HD106NS400	Necked		4"	100	10

## LATCHES



### 20/2 & 20/3 LIGHT SUFFOLK LATCH

#### CORE USE

- Traditional door and gate fastener allowing opening from either side
- Commonly used on garden gates, timber ledge and brace doors
- Short thumb piece of 75mm



Code	Finish	Pattern	Plate Width	Plate Length	Screw Holes	Screw Gauge	Box Qty
HD20B020	EPOXY BLACK	20/2	1 3/4"	7 1/2"	12	6	5
HD20B030		20/3	1 7/8"	8"	12	6	5
HD20Z020	BZP	20/2	1 3/4"	7 1/2"	12	6	5
HD20Z030		20/3	1 7/8"	8"	12	6	5

### 20/5 HEAVY SUFFOLK LATCH

#### CORE USE

- Traditional door and gate fastener allowing opening from either side of the door or gate
- Short thumb piece of 75mm



Code	Finish	Plate Width	Plate Length	Screw Holes	Screw Gauge	Box Qty
HD20G050	GALVANISED	1 7/8"	8"	12	6	5

### 20/5 LONG THUMB HEAVY SUFFOLK LATCH

#### CORE USE

- Traditional door and gate fastener allowing opening from either side
- For use with heavier duty gates and doors
- Long thumb piece of 108mm



Code	Finish	Plate Width	Plate Length	Screw Holes	Screw Gauge	Box Qty
HD20LB050	EPOXY BLACK	1"	8"	12	6	5
HD20LZ050	BZP	1"	8"	12	6	5
HD20LG050	GALVANISED	1"	8"	12	6	5

### 1136 RING GATE LATCH PLAIN

#### CORE USE

- Traditional, popular method for fastening single and double garden gates
- Rings on both sides of the gate are joined with a spindle which lifts the latch arm



Code	Finish	Size	Size (mm)	Screw Holes	Screw Gauge	Box Qty
HD1136B500	EPOXY BLACK	5"	125	12	8	5
HD1136B600		6"	150	12	8	5
HD1136B700		7"	175	12	8	5
HD1136Z500	BZP	5"	125	12	8	5
HD1136Z600		6"	150	12	8	5
HD1136Z700		7"	175	12	8	5
HD1136G500	GALVANISED	5"	125	12	8	5
HD1136G600		6"	150	12	8	5
HD1136G700		7"	175	12	8	5

### 1141 RING GATE LATCH TWISTED

#### CORE USE

- Decorative twisted handle provides a variation from 1136 plain ring gate latch



Code	Finish	Size	Size (mm)	Screw Holes	Screw Gauge	Box Qty
HD1141B600	EPOXY BLACK	6"	150	12	8	5
HD1141G600	GALVANISED	6"	150	12	8	5

### 1819 AUTO GATE LATCH

#### CORE USE

- Medium duty gate latch which is commonly found on smaller garden gates
- When the gate gets shut, it automatically engages the catch and stays shut
- Self-latching action

CAN BE PADLOCKED FOR ADDED SECURITY



Code	Finish	Description	Screw Holes	Screw Gauge	Box Qty
HD1819J	EPOXY BLACK	1819 Medium	6	8	10
HD1819Z	BZP	1819 Medium	6	8	10
HD1819SPG	GALVANISED	1819 Medium	6	8	10
HD1819ZPEG	BZP	Peg Only	2	8	10

### 1822 STRONG AUTO GATE LATCH

#### CORE USE

- Heavy duty gate latch used on heavier garden gates
- Self-latching action

CAN BE PADLOCKED FOR ADDED SECURITY



Code	Finish	Description	Screw Holes	Screw Gauge	Box Qty
HD1822J	EPOXY BLACK	1822 Heavy	6	8	10
HD1822Z	BZP	1822 Heavy	6	8	10
HD1822G	GALVANISED	1822 Heavy	6	8	10

### 610 WIRE HASP & STAPLE

**CORE USE**

- Light duty method of padlocking a gate or door
- Wire pattern



Code	Finish	Size	Size (mm)	Screw Holes	Screw Gauge	Box Qty
HD610B250	EPOXY BLACK	2½"	63	5	4	50
HD610B300		3"	75	5	4	50
HD610B400		4"	100	5	4	25
HD610B600		6"	150	8	6	10

### 617 SAFETY HASP & STAPLE

**CORE USE**

- When locked, all fixings are covered providing additional security



Code	Finish	Size	Size (mm)	Screw Holes	Screw Gauge	Box Qty
HD617B300	EPOXY BLACK	3"	75	6	8	10
HD617B450		4½"	113	7	8	10
HD617B600		6"	150	7	10	10
HD617Z300	BZP	3"	75	6	8	10
HD617Z450		4½"	113	7	8	10
HD617Z600		6"	150	7	10	10

### 149H HEAVY HASP & STAPLE

**CORE USE**

- Designed to secure heavy doors
- Can be bolted in place eliminating the ability to remove fixings



Code	Finish	Size	Size (mm)	Screw Holes	Screw Gauge	Bolt Size	Box Qty
HD149B080	EPOXY BLACK	8"	200	8	8	M10	5
HD149B100		10"	250	8	8	M10	5
HD149B120		12"	300	8	8	M10	5
HD149Z080	BZP	8"	200	8	8	M10	5
HD149Z100		10"	250	8	8	M10	5
HD149Z120		12"	300	8	8	M10	5
HD149G080	GALVANISED	8"	200	8	8	M10	5
HD149G100		10"	250	8	8	M10	5
HD149G120		12"	300	8	8	M10	5

### 146 HEAVY VERTICAL HASP & STAPLE

**CORE USE**

- Designed to secure heavy doors where there is a horizontal restriction
- Can be bolted in place eliminating the ability to remove fixings



Code	Finish	Size	Size (mm)	Screw Holes	Screw Gauge	Box Qty
HD146B060	EPOXY BLACK	6"	150	8	10	5
HD146G060	GALVANISED	6"	150	8	10	5

### 147 HEAVY SWIVEL LOCKING BAR

**CORE USE**

- Used primarily on heavy double doors
- Designed for gates that open outwards



Code	Finish	Size	Size (mm)	Screw Holes	Screw Gauge	Box Qty
HD147B080	EPOXY BLACK	8"	200	12	8	5
HD147B100		10"	250	12	8	5
HD147B120		12"	300	12	8	5
HD147B140		14"	350	12	8	5
HD147G080	GALVANISED	8"	200	12	8	5
HD147G100		10"	250	12	8	5
HD147G120		12"	300	12	8	5
HD147G140		14"	350	12	8	5

## CABIN HOOKS

Our cabin hooks **include cabin hook and eye latch**. Ideal for holding french doors, patio doors or windows open but not designed for security.

### 1261 WIRE CABIN HOOK

**CORE USE**

- Ideal for garden gates
- Used to restrain door and gate movement



Code	Finish	Size	Size (mm)	Screw Holes	Screw Gauge	Box Qty
HD1261B030	EPOXY BLACK	3"	75	8	6	20
HD1261B040		4"	100	8	6	20
HD1261B060		6"	150	8	8	10
HD1261B080		8"	200	8	8	10
HD1261B100		10"	250	8	8	10
HD1261B120		12"	300	8	8	10
HD1261Z030	BZP	3"	75	8	6	20
HD1261Z040		4"	100	8	6	20
HD1261Z060		6"	150	8	8	10
HD1261Z080		8"	200	8	8	10
HD1261Z100		10"	250	8	8	10
HD1261Z120		12"	300	8	8	10

### 37 CAST CABIN HOOK

**CORE USE**

- Heavier duty cabin hook which is commonly used for securing or restraining doors or gates



Code	Finish	Size	Size (mm)	Screw Holes	Screw Gauge	Box Qty
HD37B040	EPOXY BLACK	4"	100	4	8	10
HD37B060		6"	150	4	8	10
HD37B080		8"	200	4	8	10
HD37B100		10"	250	4	8	10
HD37B120		12"	300	4	8	10
HD37G040		GALVANISED	4"	100	4	8
HD37G060	6"		150	4	8	10
HD37G080	8"		200	4	8	10
HD37G100	10"		250	4	8	10
HD37G120	12"		300	4	8	10



## 500 GATE SPRING

### CORE USE

- Ideal for garden and most outside gates where a self closing action is required

EASY TO INSTALL  
NO MOVING PARTS TO GO WRONG



Code	Finish	Size	Size (mm)	Screw Holes	Screw Gauge	Box Qty
HD500B10	EPOXY BLACK	8"	200	4	8	10
HD500B12		10"	250	4	8	10
HD500Z10	BZP	8"	200	4	8	10
HD500Z12		10"	250	4	8	10

## 1470 CONCEALED DOOR CLOSER

### CORE USE

- Suitable for internal doors, except those fitted with rising butt, parliament or projecting hinges
- Once fitted, the only parts visible are the anchor plate and chain
- Single chain closer with choice of finishes and end patterns

ELECTRO BRASS  
RADIUS END

NICKEL PLATED  
SQUARE END



COMPLETE WITH FITTINGS

Code	Finish	Type	Box Qty
HD1470EBRA	ELECTRO BRASS	Radius End	1
HD1470EBSQ		Square End	1
HD1470NPRA	NICKEL PLATED	Radius End	1
HD1470NPSQ		Square End	1

## PERKO R2 CONCEALED DOOR CLOSER

### CORE USE

- Suitable for internal medium and lightweight doors including latched half hour and one hour fire doors

EASY TO INSTALL  
NO NEED FOR MAINTENANCE  
INVISIBLE WHEN DOOR IS CLOSED

### MATERIAL

- Solid brass manufactured to ISO 9001 : 2008



COMPLETE WITH SCREWS & INSTRUCTIONS

Code	Finish	Type	Box Qty
HDR2SPB	POLISHED BRASS	Square End	1

## DORMA TS68 DOOR CLOSER

### CORE USE

- A low cost overhead door closer which can be universally used on all common door types
- Suitable for internal doors up to 1100mm wide or 60kg max. weight

EASY TO INSTALL  
DOES NOT REQUIRE A MOUNTING  
BACK PLATE  
ADJUSTABLE CLOSING SPEED



COMPLETE WITH FITTINGS

Code	Finish	Size	Box Qty
HDTS68	SILVER	EN 2/3/4	1

## GARAGE DOOR HOLDERS

### 1010 SENIOR

- For wide lintels  
(underside fixing)

### 1011 SENIOR

- For narrow lintels  
(side fixing)

### 1012 JUNIOR

- Light pattern for wide lintels  
(underside fixing)



SOLD IN PAIRS

Code	Finish	Type	Length (mm)	Pairs Per Box	Pairs Per Outer
HD1010B	EPOXY BLACK	1010 Senior	610	1	12
HD1011B		1011 Senior	610	1	8
HD1012B		1012 Junior	380	1	1

## MORTICE LATCH

### CORE USE

- Tubular mortice latches used for keeping doors closed
- They latch the door closed until the lever or knobs fitted to the door are operated



COMPLETE WITH FIXINGS & STRIKE PLATES

Code	Finish	Size	Size (mm)	Box Qty
HDTML25	NICKEL PLATED	2½"	63	10
HDTML3		3"	75	10
HDTMLEB25	ELECTRO BRASS	2½"	63	10
HDTMLEB3		3"	75	10

## RIM LOCK & RIM KNOB

### CORE USE

- Traditionally used on back doors and out-buildings
- Lock complete with keys, fixings, and keep

### MATERIAL

- Plastic rim knob suitable for rim lock or mortice lock



KNOB SUPPLIED WITH FIXINGS & SPINDLE

Code	Finish	Description	Size	Box Qty
HDRL	BLACK	Rim Lock	5½" x 3"	1
HDRLB0604		Rim Lock	6" x 4"	1
HDRK		Plastic Rim Knob	-	5



# GATE PRO

## LONG THROW LOCK

### LONG THROW LOCK

A locking bolt with a round cylinder available keyed each side or on one side only. They come with all fixings and either 50 or 70mm cylinder projections.

Keyed alike KA1 available - all keyed with the same key pattern and enable one key to be used for numerous locks.

#### VARIANTS

- Double Locking (lock/lock): keyed both sides
- Latch Locking (latch/lock): keyed outside only with a quick release button on the inside
- Two cylinder projections available (50-70mm)
- Keyed alike variants and pull handles available

#### DOUBLE LOCKING



#### LATCH LOCKING



COMPLETE WITH ALL FITTINGS INCLUDING 28MM DRILL BIT AND 5 KEYS

Code	Finish	Type	Size (mm)	Box Qty
HDTLSSA050	STAINLESS STEEL	Double Locking	50	1
HDTLSSA070		Double Locking	70	1
HDTLSSB050		Latch Locking	50	1
HDTLSSB070		Latch Locking	70	1
HDTLSSAKA1050		Keyed Alike KA1 Double Locking	50	1
HDTLSSAKA1070		Keyed Alike KA1 Double Locking	70	1
HDTLSSBA1050		Keyed Alike KA1 Latch Locking	50	1
HDTLSSBA1070		Keyed Alike KA1 Latch Locking	70	1

#### PULL BACK HANDLE



#### BLANK KEY



Code	Finish	Type	Size (mm)	Box Qty
HDTLH08B	BLACK	Pull Handle	135	10
HDTLH08CP	CHROME PLATED	Pull Handle	135	10
HDTLH08PB	POLISHED BRASS	Pull Handle	135	10
HDTLKBL	-	Blank Uncut Key	-	1



- ↳ **Elongated Keep**
- 🔧 **Built to Last**
- 🕒 **Easy to Fit**
- 🔑 **6 Pin Security Cylinder**
- 🔧 **Complete with all Fixings**
- 🔑 **Complete with 5 Keys**
- 🔧 **Free 28mm Flat Drill Bit Inside**

## 500 CASEMENT STAY

### CORE USE

- Can be used with top or side hung casement windows
- Supplied complete with two pins



Code	Finish	Size	Size (mm)	Screw Holes	Screw Gauge	Box Qty
HD500R100	EPOXY BROWN	10"	250	6	8	10
HD500W100	EPOXY WHITE	10"	250	6	8	10

## A1 SASH FASTENER

### CORE USE

- Used to fasten sash windows
- The screw down arm gives a very secure fitting between the top and bottom sash



Code	Finish	Screw Holes	Screw Gauge	Box Qty
HDA1E	ELECTRO BRASS	5	6	10
HDA1Z	BZP	5	6	10

## 504 CASEMENT FASTENER

### CORE USE

- Used for the fastening of side hung casement windows

### MATERIAL

- Pressed steel design



Code	Finish	Screw Holes	Screw Gauge	Box Qty
HD504W	EPOXY WHITE	4	8	10

## 655 QUADRANT SASH FASTENER

### CORE USE

- Used for securing sliding sash windows
- The quadrant arm style gives a more secure fit than the A1 Sash Fastener, however it is less suitable where the top and bottom sash do not fit precisely

### QUADRANT ARM FOR EASE OF USE



### MATERIAL

- Solid brass

Code	Material	Screw Holes	Screw Gauge	Box Qty
HD655E	SOLID BRASS	7	6	10

## 521 CASEMENT FASTENER

### CORE USE

- Used for fastening side hung casement windows
- Provided complete with both hook and mortice plates

### MATERIAL

- Malleable steel



Code	Finish	Type	Screw Holes	Screw Gauge	Box Qty
HD521HB	EPOXY BLACK	Hook/Mortice	4	8	10

## 561 CASEMENT STAY CURLY TAIL

### CORE USE

- For use with top or side hung casement windows and complete with two casement stay pins (pins also available separately)



Code	Finish	Size	Size (mm)	Screw Holes	Screw Gauge	Box Qty
HD561DB100	EPOXY BLACK	10"	250	6	8	10
HD561DB120		12"	300	6	8	10
HD561PB		561P Casement Stay Pin Only			2	8

## 674 FITCH FASTENER

### CORE USE

- The narrow top sash piece makes this fastener suitable for double glazed sash windows
- Simple rotating action for easy opening and closing

### SWIVELLING CAM ENSURES A FIRM ENGAGEMENT



### MATERIAL

- Bright Zinc Plated

Code	Finish	Screw Holes	Screw Gauge	Box Qty
HD674Z	BZP	4	7	10

Solid braided and waxed cotton sash cord available in our **Building Products** section.





## FIELDGATE HINGE SETS

### STANDARD HINGE SET

#### SET CONTAINS

- 1 x long top hinge
- 1 x short bottom hinge
- 1 x hook to bolt
- 1 x hook to drive



**SUITABLE FOR**  
ANY 3" WOODEN FIELDGATE  
AND 4"-8" GATE POSTS

COMPLETE WITH ALL FIXINGS

Code	Finish	Size	Sets Per Box
HFSFG12025	GALVANISED	12" Top Hinge	1
HFSFG18025		18" Top Hinge	1
HFSFG24025		24" Top Hinge	1

### ADJUSTABLE HINGE SET

#### SET CONTAINS

- 1 x long top hinge
- 1 x adjustable eyebolt with U brackets
- 1 x hook to bolt
- 1 x hook to drive



**SUITABLE FOR**  
ANY 3" WOODEN FIELDGATE  
AND 4"-8" GATE POSTS

COMPLETE WITH ALL FIXINGS

Code	Finish	Size	Sets Per Box
HFSAG12025	GALVANISED	12" Top Hinge	1
HFSAG18025		18" Top Hinge	1
HFSAG24025		24" Top Hinge	1

### HINGE SET WITH RISING HINGE

The rising hinge aids the self closing of the fieldgate and lifts the gate as it opens.

#### SET CONTAINS

- 1 x long top hinge
- 1 x short rising bottom hinge (incl. plate)
- 1 x hook to bolt



**SUITABLE FOR**  
ANY 3" WOODEN FIELDGATE  
AND 4"-8" GATE POSTS

COMPLETE WITH ALL FIXINGS

Code	Finish	Size	Sets Per Box
HFSRG24025	GALVANISED	24" Top Hinge	1

### STANDARD HINGE SET WITH HOOKS ON PLATES

#### SET CONTAINS

- 1 x long top hinge
- 1 x short bottom hinge
- 2 x hooks on plates (4" x 4" with 19mm pins)



**SUITABLE FOR**  
ANY 3" WOODEN FIELDGATE  
AND 4"-8" GATE POSTS

COMPLETE WITH ALL FIXINGS

Code	Finish	Size	Sets Per Box
HFSHG12025	GALVANISED	12" Top Hinge	1
HFSHG18025		18" Top Hinge	1
HFSHG24025		24" Top Hinge	1

### ADJUSTABLE HINGE SET WITH HOOKS ON PLATES

#### SET CONTAINS

- 1 x long top hinge
- 1 x adjustable eyebolt with U brackets
- 2 x hooks on plates (4" x 4" with 19mm pins)



**SUITABLE FOR**  
ANY 3" WOODEN FIELDGATE  
AND 4"-8" GATE POSTS

COMPLETE WITH ALL FIXINGS

Code	Finish	Size	Sets Per Box
HFSHAG12025	GALVANISED	12" Top Hinge	1
HFSHAG18025		18" Top Hinge	1
HFSHAG24025		24" Top Hinge	1



## FIELDGATE HINGES & FASTENERS

### SPRING FASTENER COMPONENTS

#### MATERIAL

- Galvanised for corrosion resistance



#### SPRING LATCH

- Fitted to the end of the fieldgate



#### KEEP

- Retains the spring latch in place on the end of the gate



#### STAPLE CATCH

- Fixed to the face of the post to retain the spring latch in closed position

Code	Finish	Type	Box Qty
HFFAG	GALVANISED	Spring Latch	1
HFFBG		Keep	1
HFFCG		Catch	1

### SPRING FASTENER SET

#### CORE USE

- Ideal for use on single gate posts
- Simply pull the lever to release the catch



#### SET CONTAINS

- 1 x forged spring latch
- 1 x staple catch
- 1 x keep

COMPLETE WITH ALL FIXINGS



Code	Finish	Box Qty
HFSSG	GALVANISED	1

Stock fence and wire in our Fencing section.



### DOUBLE STRAP HINGES

#### CORE USE

- Long hinges typically used at the top of a field gate with short hinges at the bottom
- Short hinges can be used as both top and bottom hinge for pedestrian gates

#### MATERIAL

- Galvanised for corrosion resistance

FOR USE WITH 19MM PIN

SUITABLE FOR ANY 3" WOODEN FIELDGATE & 4"-8" GATE POSTS



Code	Finish	Type	Length	Length (mm)	Band Width	Band Thickness	Box Qty
HFFLG12025	GALVANISED	Long	12"	300	2"	1/4"	1
HFFLG18025		Long	18"	450	2"	1/4"	1
HFFLG24025		Long	24"	600	2"	1/4"	1
HFFSG05025		Short	5"	125	2"	1/4"	1

### RISING HINGES

#### CORE USE

- Aids the self closing of the fieldgate and lifts the gate as it opens
- The non-hinge end of the fieldgate will rise approx. 75mm for every 1 metre width of gate when opened through 90°

#### MATERIAL

- Galvanised for corrosion resistance



Code	Finish	Length	Length (mm)	Band Width	Band Thickness	Rocker Plate Size	Box Qty
HFFRG05025	GALVANISED	5"	125	2"	1/4"	6" x 6"	1

### DOUBLE GATE FASTENER SET

#### CORE USE

- Can secure an entrance, field or driveway gate
- The throwover gate loop will ensure the gates are kept closed
- The garage door bolt is used to keep either or both gates open or closed

#### MATERIAL

- Galvanised for corrosion resistance

#### SET CONTAINS

- Either 1 or 2 x 1260 garage door bolt(s)
- 1 x throwover gate loop



Code	Finish	Set Includes	Box Qty
HFSDGFS1B	GALVANISED	1 x 1260 Garage Door Bolt	1
HFSDGFS2B		2 x 1260 Garage Door Bolts	1



### ADJUSTABLE EYES

#### CORE USE

- Used to hang timber or metal gates

COMPLETE WITH 2 X NUTS



Code	Finish	Size	To Suit Pin Size	To Suit Pin Size (mm)	Box Qty	
HFFEZ1204	BZP	4"	1/2"	13	1	
HFFEZ1206		6"	1/2"	13	1	
HFFEZ1604		4"	5/8"	16	1	
HFFEZ1606		6"	5/8"	16	1	
HFFEZ1904		4"	3/4"	19	1	
HFFEZ1906		6"	3/4"	19	1	
HFFEZ1910		10"	3/4"	19	1	
HFFEZ2506		6"	1"	25	1	
HFFEG1204		GALVANISED	4"	1/2"	13	1
HFFEG1604			4"	5/8"	16	1
HFFEG1606	6"		5/8"	16	1	
HFFEG1904	4"		3/4"	19	1	
HFFEG1906	6"		3/4"	19	1	
HFFEG1910	10"		3/4"	19	1	
HFFEG2506	6"		1"	25	1	

### ADJUSTABLE EYE U BRACKETS

#### CORE USE

- Use with adjustable gate eyes

#### MATERIAL

- Galvanised for corrosion resistance

TO SUIT  
3/4" PIN & 3" GATES



Code	Finish	Box Qty
HFFGG	GALVANISED	1

### ADJUSTABLE BOTTOM GATE FITTING

#### CORE USE

- Used for hanging and fitting field gates

TO SUIT  
3/4" PIN & 3" GATES



COMPLETE WITH:  
2 X NUTS  
2 X U BRACKETS

Code	Finish	Size	To Suit Pin Size	To Suit Pin Size (mm)	Box Qty
HFFFG	GALVANISED	10"	3/4"	19	1
HFFFZ	BZP	10"	3/4"	19	1

### HOOK TO BOLT

#### CORE USE

- Used with fieldgates and other large driveway gates
- Bolt through the post for a strong hinging point

TO SUIT  
4" - 8" GATE POSTS



COMPLETE WITH:  
1 X NUT  
1 X WASHER

Code	Finish	Pin Size	Pin Size (mm)	Length	Box Qty
HFOBC110075	GALVANISED	3/4"	19	11"	1
HFOBC130075		3/4"	19	13"	1

### HOOK TO DRIVE

#### CORE USE

- Suitable for driving into wooden gate posts

#### MATERIAL

- Galvanised for corrosion resistance

TO SUIT  
3/4" PIN & 3" GATES



Code	Finish	Pin Size	Pin Size (mm)	Length	Box Qty
HFOGD080075	GALVANISED	3/4"	19	8"	1

### GATE HANGER TO BOLT

#### CORE USE

- Gate attachment for wooden gates and posts via a hook to bolt that allows some adjustment

#### MATERIAL

- Galvanised for corrosion resistance

COMPLETE WITH:  
1 X WELDED WASHER  
1 X ROUND WASHER & NUT



Code	Finish	Pin Size	Pin Size (mm)	Length	Box Qty
HFOHG12075	GALVANISED	3/4"	19	12"	1
HFOHG13075		3/4"	19	13"	1
HFOHG14075		3/4"	19	14"	1

### HOOK FOR BRICKWORK

#### CORE USE

- 4 1/2" for hanging gates onto single skin brickwork
- 9" used when double skin brick and masonry are involved

#### MATERIAL

- Galvanised for corrosion resistance



Code	Finish	Pin Size	Pin Size (mm)	Length	Box Qty
HFOUG045075	GALVANISED	3/4"	19	4 1/2"	1
HFOUG090075		3/4"	19	9"	1

### HOOK ON PLATE

#### CORE USE

- For fixing a fieldgate to masonry or wooden posts
- The adjustable hinge hook allows you to alter the position on the hinge so it fits the gate properly

#### MATERIAL

- Galvanised for corrosion resistance

SQUARE      SQUARE ADJUSTABLE      NARROW



Code	Finish	Type	Pin Size	Pin Size (mm)	Plate Size	Box Qty
HFOSG040075	GALVANISED	Square	3/4"	19	4" x 4"	1
HFOAGO40075		Sq. Adjustable	3/4"	19	4" x 4"	1
HFOSG080020075		Narrow	3/4"	19	8" x 2"	1

# FIELDGATE LATCHES & CATCHES

## HEAVY SELF LOCKING GATE LATCH

**CORE USE**

- Provides full functionality from both sides of the gate
- The gate is 'locked' in place when closed
- Can be padlocked for security

**MATERIAL**

- Galvanised for corrosion resistance



STRIKERS AVAILABLE SEPARATELY

Code	Finish	Box Qty
HFCHG	GALVANISED	1

## CATCH FOR CENTRAL CLOSING GATE

**CORE USE**

- Used in conjunction with a spring latch and keep to allow a gate to be opened in two directions where the gate is hung between the posts

**MATERIAL**

- Galvanised for corrosion resistance



Code	Finish	Box Qty
HFCCG	GALVANISED	1

## CAST GRAVITY CATCH TO CONCRETE IN

**CORE USE**

- Acts to hold open a fieldgate
- When cast into concrete, the gate will self latch on the catch

**MATERIAL**

- Galvanised for corrosion resistance



Code	Finish	Box Qty
HFCCG	GALVANISED	1

## SPRING LOADED BOLT

Also known as an "animal bolt".

**CORE USE**

- For securing wooden or metal gates and doors

**MATERIAL**

- Pre-drilled fixing plate



Code	Finish	Size	Box Qty
HFBSG0375	BZP	3/8"	1
HFBSG0050		1/2"	1
HFBSG0375		5/8"	1

## GATE LATCH STRIKERS

**CORE USE**

- Used on wooden gates in conjunction with heavy self locking gate latch
- The cranked striker gives more potential for adjustment when fitting

**MATERIAL**

- Galvanised for corrosion resistance



Code	Finish	Type	Box Qty
HFCHSG	GALVANISED	Straight	1
HFCHCC		Cranked	1

## GATE STAPLE CATCH TO DRIVE

**CORE USE**

- Can be used with a heavy self-locking gate latch
- Square pattern to drive in

**MATERIAL**

- Galvanised for corrosion resistance



Code	Finish	Size	Box Qty
HFSSG04	GALVANISED	4"	1

## KICKOVER GATE LATCH

**CORE USE**

- Traditionally used for stable doors or other applications where there needs to be a hands free shutting method

**MATERIAL**

- Galvanised for corrosion resistance



Code	Finish	Box Qty
HFCKG	GALVANISED	2

## THROWOVER GATE LOOP

**CORE USE**

- Used for keeping double gates in the shut position
- To suit 3" gates

**MATERIAL**

- Galvanised for corrosion

STANDARD LARGE



STANDARD SMALL



LOCKABLE & WITH HANDLE FOR EASIER USE



Code	Finish	Type	Size	Box Qty
HFFTG0615	GALVANISED	Standard Small	6" x 2"	1
HFFTG142		Standard Large	14" x 2"	1
HFFTG18		With Handle	18"	1
HFFTLG18		With Handle & Lockable	18"	1

### FIELDGATE SUNDRIES

#### SAFETY GATE HOOK & EYE

**CORE USE**

- Designed to prevent the opening of wooden gates by animals

**MATERIAL**

- Galvanised for high corrosion resistance



Code	Finish	Box Quantity
HFFSGH	GALVANISED	10

#### SLIP RAIL BRACKET SET

**CORE USE**

- Gate catch to provide simple access to a field or paddock
- Brackets will accommodate wooden rails up to 100 x 50mm

**MATERIAL**

- Galvanised for high corrosion resistance



Code	Finish	Box Quantity
HFFSR	GALVANISED	10

#### GATE HOOKS & EYES TO WELD

**CORE USE**

- Heavy duty hooks and eyes for metal gates and posts



**FLAT**

- FOR BOX SECTION POSTS
- CAN BE WELDED TO STRAIGHT END-BASE

**RADIUS**

- FOR ROUND SECTION POSTS
- CAN BE WELDED TO ROUND BARS OR TUBES

Code	Finish	Description	Type	Size (mm)	Box Qty
HFWEFS12	SELF COLOUR	Gate Eyes	Flat	12	10
HFWEFS16		Gate Eyes	Flat	16	10
HFWEFS19		Gate Eyes	Flat	19	10
HFWEFS25		Gate Eyes	Flat	25	10
HFWERS19		Gate Eyes	Radius	19	10
HFWHFS12		Gate Hooks	Flat	12	10
HFWHFS16		Gate Hooks	Flat	16	10
HFWHFS19		Gate Hooks	Flat	19	10
HFWHFS25		Gate Hooks	Flat	25	10
HFWHRS19		Gate Hooks	Radius	19	10

### HEAVY CHAIN ACCESSORIES

#### 510 MANGER RING ON EYE

**CORE USE**

- Ideal for outdoor wooden posts and as an animal manger ring

SECURE ATTACHMENT FULLY THREADED



COMES WITH:  
1 X WASHER  
2 X NUTS

Code	Finish	Ring Radius	Bolt Length	Box Qty
HS510G300	BZP	3"	8"	10

#### 511 HOOK ON PLATE

**CORE USE**

- Ideal for use in industries and domestic applications where chains or ropes need to be securely held
- For attaching chain to wooden post

PREDRILLED FOR USE WITH COUNTERSUNK SCREWS

HEAVY DUTY OUTDOOR USE



**MATERIAL**

- Galvanised for corrosion resistance

COMES WITH EYE AND 6" CHAIN

Code	Finish	Plate Size	Plate Size (mm)	Box Qty
HS511G200	GALVANISED	2" x 2"	50 x 50	10

#### 512 STAPLE ON PLATE

**CORE USE**

- Wall or post attachment for chain or rope, ideal as an anchor point
- Used for securing gates and fences with chain or bolts through the staple

PREDRILLED FOR USE WITH COUNTERSUNK SCREWS

HEAVY DUTY OUTDOOR USE



**MATERIAL**

- Galvanised for corrosion resistance

Code	Finish	Plate Size	Plate Size (mm)	Box Qty
HS512G200	GALVANISED	2" x 2"	50 x 50	10

#### 513 MANGER RING ON PLATE

**CORE USE**

- Allows for rope to pass through the ring providing an anchor point

**MATERIAL**

- Galvanised for corrosion resistance



PREDRILLED FOR USE WITH COUNTERSUNK SCREWS  
HEAVY DUTY OUTDOOR USE

Code	Finish	Plate Size	Plate Size (mm)	Box Qty
HS513G200	GALVANISED	2" x 2"	50 x 50	10

## FURNITURE CONSTRUCTION & REPAIR

A RANGE OF INDUSTRY STANDARD PLATES AND BRACES IDEALLY SUITED TO CONSTRUCTION & REPAIR OF KITCHEN UNITS AND CUPBOARDS

### 315 STRETCHER PLATE

#### CORE USE

- Commonly used for joinery or kitchen fitting
- Used when work surfaces need to be moved slightly and tightened in place

#### MATERIAL

- Bright Zinc Plated for an enhanced appearance and a smooth finish

**PREDRILLED**  
FOR USE WITH  
COUNTERSUNK SCREWS

**PLATES**  
GIVE FLEXIBILITY  
FOR POSITIONING

**OVAL SLOTS**  
ALLOWING FOR  
MISALIGNED  
SCREWS



Code	Finish	Size	Size (mm)	Screw Holes	Screw Gauge	Box Qty
HS315Z150	BZP	1 1/2"	38	2	8	100

### 318 TEE PLATE

#### CORE USE

- For timber and kitchen repairs or as an additional support

#### MATERIAL

- Bright Zinc Plated for an enhanced appearance and a smooth finish

**PREDRILLED**  
FOR USE WITH  
COUNTERSUNK SCREWS



Code	Finish	Size	Size (mm)	Screw Holes	Screw Gauge	Box Qty
HS318Z300	BZP	3"	75	5	8	25
HS318Z400		4"	100	5	8	25

### 319 CORNER BRACE

#### CORE USE

- Ideal for use with shelves, worktops, connecting wood or strengthening inside corners
- For specialist fixing applications or repairing joints
- Less conspicuous compared to those mounted on the face

#### MATERIAL

- Bright Zinc Plated for an enhanced appearance and a smooth finish

**PREDRILLED**  
FOR USE WITH  
COUNTERSUNK SCREWS



Code	Finish	Size	Size (mm)	Screw Holes	Screw Gauge	Box Qty
HS319Z075R	BZP	3/4" Radius	19	2	6	500
HS319Z100		1"	25	2	6	50
HS319Z150		1 1/2"	38	4	6	50
HS319Z200		2"	50	4	6	50
HS319Z250		2 1/2"	63	4	7	50
HS319Z300		3"	75	6	7	50
HS319Z400		4"	100	6	8	25
HS319Z500		5"	125	6	8	25
HS319Z600		6"	150	6	10	25

### 324 CORNER PLATE

Also known as "angle plate".

**PREDRILLED**  
FOR USE WITH  
COUNTERSUNK SCREWS

#### CORE USE

- Used for strengthening corner pieces of timber

#### MATERIAL

- Bright Zinc Plated for an enhanced appearance and a smooth finish



Code	Finish	Size	Size (mm)	Screw Holes	Screw Gauge	Box Qty
HS324Z200	BZP	2"	50	4	5	50
HS324Z250		2 1/2"	63	4	6	50
HS324Z300		3"	75	4	6	50
HS324Z400		4"	100	4	8	25
HS324Z500		5"	125	6	8	25
HS324Z600		6"	150	8	8	25

### 325 MENDING PLATE

#### CORE USE

- Used to reinforce joints
- Ideal for furniture construction or repair

#### MATERIAL

- Bright Zinc Plated for an enhanced appearance and a smooth finish

**PREDRILLED**  
FOR USE WITH  
COUNTERSUNK SCREWS



Code	Finish	Size	Size (mm)	Screw Holes	Screw Gauge	Box Qty
HS325Z300	BZP	3"	75	4	7	50
HS325Z400		4"	100	4	7	50
HS325Z500		5"	125	4	8	25
HS325Z600		6"	150	4	8	25

### 55 CUPBOARD BUTTON

#### CORE USE

- Often used on rabbit hutches

#### MATERIAL

- Cast iron with plain pattern
- Bright Zinc Plated for an enhanced appearance and a smooth finish
- Epoxy black for a higher corrosion resistance

**EASY TO FIT**  
ONLY ONE SCREW  
REQUIRED FOR  
FITTING



Code	Finish	Size	Size (mm)	Screw Holes	Screw Gauge	Box Qty
HS55Z200	BZP	2"	50	1	10	100
HS55B200	EPOXY BLACK	2"	50	1	10	100



## HANDLES & HANDRAIL BRACKETS



### 236 HANDRAIL BRACKET

#### CORE USE

- The most popular product to fix mopstick handrails to walls
- Medium duty and ideal for the home

#### MATERIAL

- Hardened steel in 3 finishes

**DESIGN**  
SIMPLE & CONTEMPORARY

**PREDRILLED**  
FOR USE WITH  
COUNTERSUNK SCREWS



WE ALSO STOCK HANDRAIL KITS IN OUR  
HANDRAILS & GRAB RAILS SECTION

Code	Finish	Size	Size (mm)	Screw Holes	Screw Gauge	Box Qty
HS236Z200	BZP	2"	50	5	8	10
HS236Z250		2½"	63	5	8	10
HS236Z300		3"	75	5	8	10
HS236B250	EPOXY BLACK	2½"	63	5	8	10
HS236W250	EPOXY WHITE	2½"	63	5	8	10

### 1100 HOTBED HANDLE

#### CORE USE

- Versatile pull handle for gate/sheds
- Simple to fix

#### MATERIAL

- Available either galvanised or epoxy black so can be used outdoors

TWO FIXING HOLES  
EACH END FOR A  
SECURE FITTING



Code	Finish	Size	Size (mm)	Screw Holes	Screw Gauge	Box Qty
HS1100B600	EPOXY BLACK	6"	150	4	8	30
HS1100B700		7"	175	4	8	20
HS1100G600	GALVANISED	6"	150	4	8	30
HS1100G700		7"	175	4	8	20

### 246 CHEST HANDLE

#### CORE USE

- Ideal for lifting chests, wooden tool boxes or fireside boxes

#### MATERIAL

- Withstands heat and cold temperatures
- Corrosion resistant finish

HEAVY DUTY



Code	Finish	Size	Size (mm)	Screw Holes	Screw Gauge	Box Qty
HS246B400	EPOXY BLACK	4"	100	4	10	5 Pairs

## PULLEYS & HOOKS

### PULLEYS

#### 202S SECRET AXLE PULLEY

- SINGLE AXLE PULLEY
- NYLON WHEEL: LIGHT & ABRASION RESISTANT
- PREDRILLED: TO BE SCREWED INTO PLACE



Code	Wheel Dia.	Wheel Dia. (mm)	Screw Size	Box Qty
HS202S	1¾"	45	8	10

#### GP039 SINGLE SCREW PULLEY

- FIXED AXLE PULLEY: SCREWS INTO PLACE
- NYLON WHEEL: LIGHT & ABRASION RESISTANT
- GUARDED FOR SAFETY



Code	Wheel Dia.	Wheel Dia. (mm)	Screw Projection (mm)	Box Qty
HSGP039	1¾"	45	63	10

#### GP042 DOUBLE SCREW PULLEY

- FIXED AXLE PULLEY: SCREWS INTO PLACE
- NYLON WHEEL: LIGHT & ABRASION RESISTANT
- ALLOWS 2 CORDS TO BE OPERATED THROUGH 1 PULLEY
- GUARDED FOR SAFETY



Code	Wheel Dia.	Wheel Dia. (mm)	Screw Projection (mm)	Box Qty
HSGP042	1¾"	45	63	10

#### GP261 LINE PULLEY

- NYLON WHEEL: LIGHT & ABRASION RESISTANT
- SINGLE WHEEL PULLEY
- INDOOR USE



Code	Size	Size (mm)	Box Qty
HSGP261	1½"	38	10

#### GP260 LINE PULLEY

- WASHING LINE PULLEY
- SINGLE WHEEL WITH A HOOK
- GALVANISED



Code	Size	Size (mm)	Box Qty
HSGP260	1½"	38	10

### G2003 & G2004 CLEAT HOOK

#### CORE USE

- Used for tidying up blind or curtain cords
- Can also be used with ceiling mounted clothes airers



Code	Description	Finish	Size	Size (mm)	Screw Holes	Screw Gauge	Box Qty
HSG2003Z400	G2003 Cleat	BZP	4"	100	2	8	10
HSG2004Z500	G2004 Cleat		5"	125	2	8	10

## ROTHLEY

### TWINSLOT

**IDEAL FOR**  
DIY USE IN THE HOME & TRADE USE  
IN COMMERCIAL & PUBLIC SECTOR BUILDINGS

**MATERIAL**  
STRONG 2MM STEEL

**LOCKING FEATURE**  
PREVENTS BRACKETS FROM DISLODGING

**EASY TO FIT**  
AND COMPATIBLE WITH OTHER SYSTEMS

**DURABLE, HARD WEARING**

- **KROME**  
PROVIDES THE SAME ATTRACTIVE MIRROR FINISH AS CHROME PLATING, WITHOUT THE HARMFUL EFFECT ON THE ENVIRONMENT
- **MATT BLACK**
- **WHITE**  
UPRIGHTS ARE ANTI-MICROBIAL

#### TWINSLOT UPRIGHTS

**CORE USE**

- Ideal for use in domestic applications like garages, workshops and sheds
- Can be butted up to each other to create longer lengths
- Fixed directly to the wall

**MATERIAL**

- Manufactured from strong steel to prevent splitting or bending under load
- Epoxy powder coating

TWINSLOTS AT 32MM INCREMENTS FOR LOCATING BRACKETS INTO

STYLISH EASY TO INSTALL HIGH QUALITY



Code	Finish	Size	Size (mm)	Box Qty
HTNTSUK16	KROME	16 3/4"	425	10
HTNTSUK28		28"	710	10
HTNTSUK39		40"	1000	10
HTNTSUK48		48"	1220	10
HTNTSUK63		63"	1600	10
HTNTSUK78		78"	1980	10
HTNTSUK94		94"	2400	10
HTNTSUMB16	MATT BLACK	16 3/4"	425	10
HTNTSUMB28		28"	710	10
HTNTSUMB39		40"	1000	10
HTNTSUMB48		48"	1220	10
HTNTSUMB63		63"	1600	10
HTNTSUMB78		78"	1980	10
HTNTSUW16	WHITE	16 3/4"	425	10
HTNTSUW28		28"	710	10
HTNTSUW39		40"	1000	10
HTNTSUW48		48"	1220	10
HTNTSUW63		63"	1600	10
HTNTSUW78		78"	1980	10
HTNTSUW94		94"	2400	10

#### TWINSLOT BRACKETS

**CORE USE**

- Ideal for use in domestic or commercial shelving
- Use with twin slot uprights

**MATERIAL**

- Manufactured from strong steel
- Epoxy powder coating



Code	Finish	Size	Size (mm)	Box Qty
HTNTSBK04	KROME	4 1/2"	120	10
HTNTSBK06		6 1/2"	165	10
HTNTSBK08		8 1/2"	216	10
HTNTSBK10		10 1/2"	267	10
HTNTSBK12		12 1/2"	317	10
HTNTSBK14		14 1/2"	368	10
HTNTSBK18		18 1/2"	470	10
HTNTSBMB06		MATT BLACK	6 1/2"	165
HTNTSBMB08	8 1/2"		216	10
HTNTSBMB10	10 1/2"		267	10
HTNTSBMB12	12 1/2"		317	10
HTNTSBMB14	14 1/2"		368	10
HTNTSBMB18	18 1/2"		470	10
HTNTSBW04	WHITE	4 1/2"	120	10
HTNTSBW06		6 1/2"	165	10
HTNTSBW08		8 1/2"	216	10
HTNTSBW10		10 1/2"	267	10
HTNTSBW12		12 1/2"	317	10
HTNTSBW14		14 1/2"	368	10
HTNTSBW18		18 1/2"	470	10

#### TWINSLOT FLEXIBLE BOOK ENDS

**CORE USE**

- Locks into position
- Prevents boxes, books or folders falling off the shelf edge

**MATERIAL**

- Manufactured from strong steel
- Epoxy powder coating



Code	Finish	Size	Size (mm)	Box Qty
HTNTSFBW250	WHITE	9 3/4"	250	10



### ROTHLEY

## FIXED BRACKETS MITRED & CANTILEVER

### MITRED BRACKETS

#### CORE USE

- Heavy duty use
- Ideal for use in domestic or commercial shelving

#### MATERIAL

- Manufactured from strong steel
- Epoxy powder coating



Code	Finish	Size	Size (mm)	Box Qty
HTNBRMB200MB	MATT BLACK	8" x 8"	200 x 200	10
HTNBRMB250MB		10" x 10"	250 x 250	10
HTNBRMB300MB		12" x 12"	300 x 300	10
HTNBRMB350MB		14" x 14"	350 x 350	10
HTNBRMB200W	WHITE	8" x 8"	200 x 200	10
HTNBRMB250W		10" x 10"	250 x 250	10
HTNBRMB300W		12" x 12"	300 x 300	10
HTNBRMB350W		14" x 14"	350 x 350	10

### CANTILEVER BRACKETS

#### CORE USE

- Ideal for use in domestic, light commercial and public sector buildings

#### MATERIAL

- Manufactured from steel for light and medium duty use



Code	Finish	Size	Size (mm)	Box Qty
HTNBRCB120MB	MATT BLACK	5" x 6"	120 x 150	10
HTNBRCB150MB		6" x 8"	150 x 200	10
HTNBRCB200MB		8" x 10"	200 x 250	10
HTNBRCB120W	WHITE	5" x 6"	120 x 150	10
HTNBRCB150W		6" x 8"	150 x 200	10
HTNBRCB200W		8" x 10"	200 x 250	10

### 422 STAY SHELF BRACKET

#### CORE USE

- For supporting large shelves where strength is required

#### MATERIAL

- Powder-coated steel construction

STRONG BEAM FOR ADDITIONAL STRENGTH



Code	Finish	Size	Size (mm)	Screw Holes	Screw Size	Box Qty
HN422Y1416	EPOXY GREY	16" x 14"	400 x 350	6	8	10
HN422Y1618	EPOXY GREY	18" x 16"	450 x 400	6	8	10

### 240 LONDON PATTERN SHELF BRACKET

#### CORE USE

- Ideal for use in the garage or utility room
- Traditional stayless pattern

#### MATERIAL

- Powder-coated steel construction

EVERYDAY USE  
PRE-DRILLED HOLES



Code	Finish	Size	Size (mm)	Screw Holes	Screw Size	Box Qty
HN240W0403	EPOXY WHITE	4" x 3"	100 x 75	6	6	20
HN240W0504		5" x 4"	125 x 100	6	6	20
HN240W0605		6" x 5"	150 x 125	6	6	20
HN240W0806		8" x 6"	200 x 150	6	6	20
HN240W0907		9" x 7"	225 x 175	6	6	20
HN240W1008		10" x 8"	250 x 200	6	6	20
HN240W1210		12" x 10"	300 x 250	6	6	20
HN240W1412		14" x 12"	350 x 300	6	6	20
HN240Y0403	EPOXY GREY	4" x 3"	100 x 75	6	6	20
HN240Y0504		5" x 4"	125 x 100	6	6	20
HN240Y0605		6" x 5"	150 x 125	6	6	20
HN240Y0806		8" x 6"	200 x 150	6	6	20
HN240Y0907		9" x 7"	225 x 175	6	6	20
HN240Y1008		10" x 8"	250 x 200	6	6	20
HN240Y1210		12" x 10"	300 x 250	6	6	20
HN240Y1412		14" x 12"	350 x 300	6	6	20

### 247 FLUTED ANGLE BRACKET

#### CORE USE

- Ideal for sheds, garages or workshops (fixing cabinets, attaching wardrobes to walls or reinforcing first fix joinery)

#### MATERIAL

- Galvanised for corrosion resistance and outdoor use

HEAVY DUTY  
PRE-DRILLED HOLES



Code	Finish	Size	Size (mm)	Screw Holes	Screw Size	Box Qty
HN247G043	GALVANISED	4" x 3"	100 x 75	4	8	20
HN247G054		5" x 4"	125 x 100	4	8	20
HN247G065		6" x 5"	150 x 125	4	10	20
HN247G086		8" x 6"	200 x 150	5	12	20
HN247G108		10" x 8"	250 x 200	6	12	20

### ORNAMENTAL SCROLL BRACKET

#### CORE USE

- Can be used for hanging baskets or to support shelves
- Ideal for use with timber or laminate shelves

#### MATERIAL

- Powder-coated metal construction

INDOOR & OUTDOOR USE



Code	Colour	Size	Size (mm)	Screw Holes	Screw Size	Box Qty
HNOS0404B	BLACK	4" x 4"	100 x 100	4	8	10
HNOS0606B		6" x 6"	150 x 150	4	8	10
HNOS0808B		8" x 8"	200 x 200	4	8	10
HNOS1010B		10" x 10"	250 x 250	4	8	10
HNOS0404W	WHITE	4" x 4"	100 x 100	4	8	10
HNOS0606W		6" x 6"	150 x 150	4	8	10
HNOS0808W		8" x 8"	200 x 200	4	8	10
HNOS1010W		10" x 10"	250 x 250	4	8	10



## WEATHERBARS

- THRESHOLDS AND WEATHERBARS FOR TIMBER, COMPOSITE AND PVC DOORS
- ALL CONFORM TO PART M BUILDING REGULATIONS
- ALL COME WITH FIXINGS AND ARE BAR CODED

### THRESHEX SILL

#### CORE USE

- Does not present an obstacle to wheeled traffic so ideal for the disabled
- Reverse the seal to enable it to work with outward opening doors

#### MATERIAL

- Aluminium body which can withstand severe weather exposure

- FOR INWARD & OUTWARD OPENING DOORS
- CONFORMS TO: BUILDING REGULATIONS PART M
- UNDERDOOR CLEARANCE: 17MM

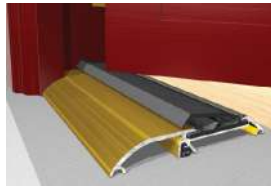

Code	Colour	Size (mm)	Pack Qty
HETRX0933MI	ALUMINIUM	933	1
HETRX1220MI		1220	1
HETRX2134MI		2134	1
HETRX0933GO	GOLD	933	1
HETRX1220GO		1220	1
HETRX2134GO		2134	1

### KLEERTRED 20 SILL

#### CORE USE

- Suitable for moderate exposure
- Deflector section is supplied with weather deflecting end caps so no sharp corners
- Wheelchair friendly

#### MATERIAL

- Aluminium body which can withstand severe weather exposure

- FOR INWARD & OUTWARD OPENING DOORS
- CONFORMS TO: BUILDING REGULATIONS PART M
- UNDERDOOR CLEARANCE: 20MM

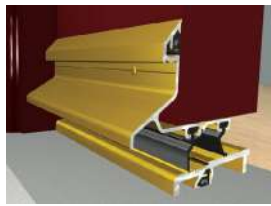

Code	Colour	Size (mm)	Pack Qty
HEKLT914MI	ALUMINIUM	914	1
HEKLT914GO	GOLD	914	1

### MACCLEX 15/2 SILL

#### CORE USE

- Suitable for moderate exposure
- Ideal for double doors and accepts MWK striker block for flush bolts in double doors
- Wheelchair friendly

#### MATERIAL

- Aluminium body which can withstand severe weather exposure

- FOR INWARD & OUTWARD OPENING DOORS
- CONFORMS TO: BUILDING REGULATIONS PART M
- UNDERDOOR CLEARANCE: 13MM

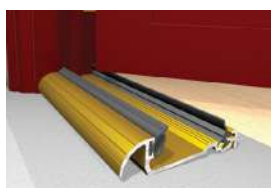

Code	Colour	Size (mm)	Pack Qty
HEMXS152914MI	ALUMINIUM	914	1
HEMXS152914GO	GOLD	914	1

### WEATHERBAR KIT (MWK 20)

#### CORE USE

- Integral thermal barrier helps prevent condensation
- Sub seal allows installation onto wet or dry thresholds
- Wheelchair friendly

#### MATERIAL

- Aluminium body which can withstand severe weather exposure

- FOR INWARD OPENING DOORS
- CONFORMS TO: BUILDING REGULATIONS PART M
- UNDERDOOR CLEARANCE: 20MM

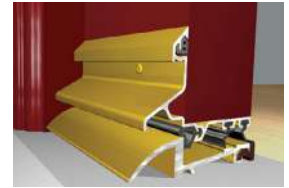

Code	Colour	Size (mm)	Pack Qty
HEMWK0914MI	ALUMINIUM	914	1
HEMWK0914GO	GOLD	914	1

### WEATHEREN BARS

#### CORE USE

- Eliminates the need to notch sill or frame during fitting
- Ideal for double doors and accepts standard striker blocks
- Suitable for very exposed locations

#### MATERIAL

- Aluminium body which can withstand severe weather exposure

- FOR INWARD OPENING DOORS & DOUBLE DOORS
- CONFORMS TO: BUILDING REGULATIONS PART M
- UNDERDOOR CLEARANCE: 20MM



#### EXITEX WEATHERTEN LOWLINE BARS

Code	Colour	Size (mm)	Pack Qty
HEWTBL0914MI	ALUMINIUM	914	1
HEWTBL1220MI		1220	1
HEWTBL0914GO	GOLD	914	1
HEWTBL1220GO		1220	1

- FOR INWARD OPENING DOORS & DOUBLE DOORS
- CONFORMS TO: BUILDING REGULATIONS PART M
- UNDERDOOR CLEARANCE: 25MM



#### EXITEX WEATHERTEN BARS

Code	Colour	Size (mm)	Pack Qty
HEWTB0914MI	ALUMINIUM	914	1
HEWTB0914GO	GOLD	914	1

### MACCLEX LOWLINE SILL

#### CORE USE

- Eliminates the need to notch sill or frame during fitting
- Ideal for double doors and accepts standard striker blocks
- Suitable for very exposed locations

#### MATERIAL

- Aluminium body which can withstand severe weather exposure

- FOR INWARD OPENING DOORS & DOUBLE DOORS
- CONFORMS TO: BUILDING REGULATIONS PART M
- UNDERDOOR CLEARANCE: 20MM

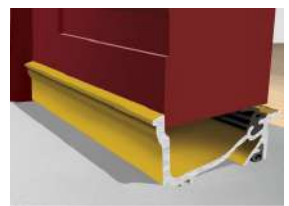

Code	Colour	Size (mm)	Pack Qty
HEMXSLL0914MI	ALUMINIUM	914	1
HEMXSLL1220MI		1220	1
HEMXSLL0914GO	GOLD	914	1
HEMXSLL1220GO		1220	1





## DEFLECTORS & GARAGE DOOR SEALS

- DEFLECTORS DESIGNED FOR MODERATE WEATHER CONDITIONS
- ALL ARE EXTERNALLY FITTED AND COME WITH WEATHER DEFLECTING END CAPS
- GARAGE DOOR SEALS BOTH CONFORM TO PART M BUILDING REGULATIONS
- ALL COME WITH FIXINGS, INSTALLATION INSTRUCTIONS AND ARE BAR CODED

### DFR20 RAIN DEFLECTOR (NO SEAL)

#### CORE USE

- Can be used in conjunction with a weather bar
- Can solve the problem of leaking weatherbars and thresholds

SUPPLIED WITH WEATHER DEFLECTING END CAPS WHICH ELIMINATE SHARP CORNERS & RAW EDGES

- FOR INWARD OPENING DOORS
- NO SEAL

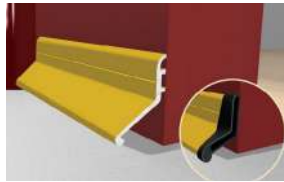

Code	Colour	Size (mm)	Pack Qty
HEDFR0914MI	ALUMINIUM	914	1
HEDFR0914GO	GOLD	914	1

### EXPELEX DEFLECTOR (WITH SEAL)

#### CORE USE

- Deflects weather and stops draughts
- Can solve the problem of leaking weatherbars and thresholds
- Surface seal enables product to be fitted without mastic

SUPPLIED WITH SEAL, FIXING SCREWS & WEATHER DEFLECTING END CAPS (FIXING SCREWS ARE PROTECTED AND CONCEALED)

- FOR INWARD & OUTWARD OPENING DOORS
- EASY TO FIT
- FITTING TOLERANCE: 6MM



Code	Colour	Size (mm)	Pack Qty
HEEXP0914MI	ALUMINIUM	914	1
HEEXP0914GO	GOLD	914	1

### ERD RAIN DEFLECTOR (NO SEAL)

#### CORE USE

- Can be used in conjunction with a weatherbar

SUPPLIED WITH WEATHER DEFLECTING END CAPS WHICH ELIMINATE SHARP CORNERS & RAW EDGES

- FOR INWARD & OUTWARD OPENING DOORS



Code	Colour	Size (mm)	Pack Qty
HEERD0914MI	ALUMINIUM	914	1
HEERD0914GO	GOLD	914	1

### GAREX FITTING INSTRUCTIONS

1. IF NECESSARY CUT THE ALUMINIUM TO LENGTH
2. ENSURE THE BOTTOM SEALING BLADE AND SURFACE SEAL ARE LEFT LONGER THAN THE ALUMINIUM
3. LEAVE THE SEALING BLADE EXTENDING BY 5MM EACH END AND PINCH THE END OF THE SEAL RETAINING CHANNEL ON BOTH SIDES OF THE DOOR
4. INSTALL END CAPS BY SLIGHTLY FLATTENING THE FINN ON THE ANCHORING TONGUE AND PUSHING THE ALUMINIUM INTO THE RECESS OF THE END CAPS. GENTLY TAP INTO PLACE
5. POSITION GAREX DEFLECTOR ENSURING THE SEALING BLADE CONTACTS THE GROUND WITH THE DOOR CLOSED
6. SCREW OR POP RIVET INTO POSITION ONTO THE DOOR

### NOTE

IF YOU ARE SCREWING GAREX INTO A SINGLE THICKNESS OF METAL DOOR, IT IS SUGGESTED YOU PLACE A STRIP OF WOOD ON THE INSIDE TO RECEIVE THE EXCESS LENGTH OF THE SCREWS

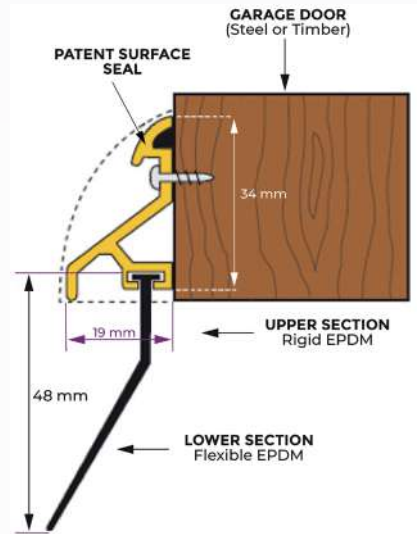

### GAREX GARAGE DOOR SEAL

#### CORE USE

- Suitable for steel, timber or composite doors
- Designed to prevent rain, dust and snow entering underneath exterior garage doors

#### MATERIAL

- Aluminium body which can withstand severe weather exposure

- FOR INWARD & OUTWARD & ROLLER SHUTTER DOORS
- EXTERNALLY FITTED
- CONFORMS TO BUILDING REGS. PART M



Code	Colour	Size (mm)	Pack Qty
HEGAREX2134MI	ALUMINIUM	2134	1

### GARIN GARAGE DOOR SEAL

#### CORE USE

- Suitable for steel, timber or composite doors
- Ideal as a draught excluder, but also prevents rain, dust and snow entering underneath external garage doors

#### MATERIAL

- Aluminium body which can withstand severe weather exposure

- FOR INWARD, OUTWARD & ROLLER SHUTTER DOORS
- INTERNALLY FITTED
- CONFORMS TO: BUILDING REGULATIONS PART M
- UNDERDOOR CLEARANCE: 45MM

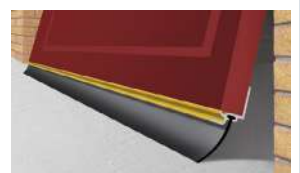

Code	Colour	Size (mm)	Pack Qty
HEGARIN2134MI	ALUMINIUM	2134	1



## DOOR SURROUNDS, SEALS & DRAUGHT EXCLUDERS

DESIGNED FOR MODERATE OR SEVERE EXPOSURE WEATHER CONDITIONS. ALL COME WITH FIXINGS AND ARE BAR CODED.

### STANDARD DOOR SURROUND

#### CORE USE

- For inward opening doors

#### MATERIAL

- Aluminium carrier with a tough flexible TPE gasket: allows 3mm of door movement at all temperatures and can withstand severe weather exposure
- Stainless steel screw (or pin) fixing for adjustment

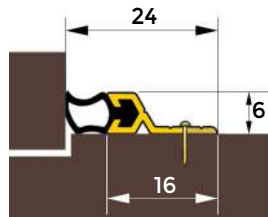

Code	Colour	Size (mm)	Pack Qty
HESDS5180MI	ALUMINIUM	5180	1
HESDS5180GO	GOLD	5180	1
HESDS5180BRZ	BRONZE	5180	1
HESDS5180WH	WHITE	5180	1

### FLEX N SEAL SET

#### CORE USE

- For inward opening doors
- Does not restrict door closing
- Allows 5mm of door movement

#### MATERIAL

- Aluminium carrier with black EPDM seal and non-stretch cord
- Aluminium body which can withstand severe weather exposure
- Stainless steel pin fixing for adjustment

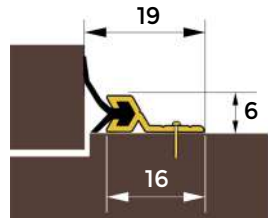

Code	Colour	Size (mm)	Pack Qty
HEFNS5180MI	ALUMINIUM	5180	1
HEFNS5180GO	GOLD	5180	1
HEFNS5180BRZ	BRONZE	5180	1
HEFNS5180WH	WHITE	5180	1

### QDS DOOR SET

#### CORE USE

- Ideal for weatherproofing around doors & windows

#### MATERIAL

- Aluminium carrier with foam filled gasket
- Aluminium body which can withstand severe weather exposure
- Stainless steel screw (pin) slot fixing for adjustment

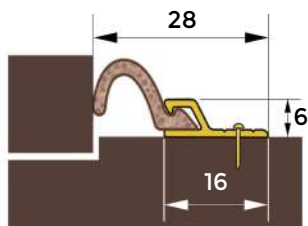

Code	Colour	Size (mm)	Pack Qty
HEQDS5180MI	ALUMINIUM	5180	1
HEQDS5180GO	GOLD	5180	1

### WINDOR PVC DOOR SURROUND

#### CORE USE

- Seals inward opening doors and hinged windows

#### MATERIAL

- Manufactured from dualhard UV stable PVC
- Self-spacing flexible blade to ensure a correct fitting
- Stainless steel pin fixing through preformed holes

FOR INTERIOR & EXTERIOR USE  
NEAT PVC PROFILE

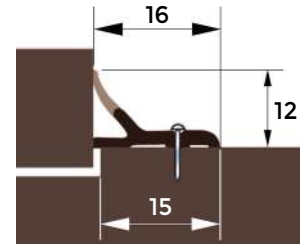

Code	Colour	Size (mm)	Pack Qty
HEWIN5180BR	BROWN	5180	1
HEWIN5180WH	WHITE	5180	1

### PVC PILE WEATHER SET

#### CORE USE

- For hinged or sliding doors and windows
- Suitable for inward opening

#### MATERIAL

- PVC carrier with resilient polypropylene pile
- Stainless steel pin fixing through preformed holes

NEAT PVC PROFILE

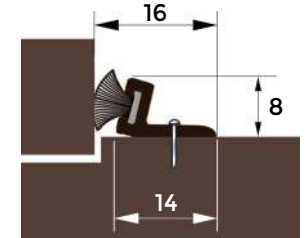

Code	Colour	Size (m)	Pack Qty
HEPWS5180BR	BROWN	5	1
HEPWS5180WH	WHITE	5	1

### BLADEX DRAUGHT EXCLUDER

#### CORE USE

- For all types of doors
- Fits to the bottom of the door

#### MATERIAL

- Aluminium carrier with TPE flipper
- Flexible PVC blade stops draughts and dust

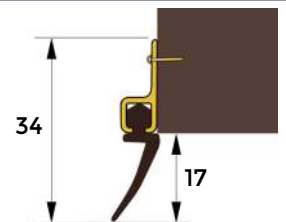

Code	Colour	Size (mm)	Pack Qty
HEBLX0914MI	ALUMINIUM	914	1
HEBLX0914GO	GOLD	914	1

### DOUBLE DOOR CENTRE SEAL

#### CORE USE

- Suits inward or outward opening double doors for draught-proofing the gap between them

#### MATERIAL

- Aluminium carrier with EDPM rubber seal
- Concealed stainless steel fixing screws
- 4mm fitting tolerance

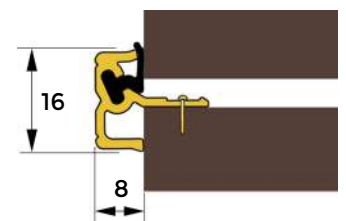

Code	Colour	Size (mm)	Pack Qty
HEDDCS2400MI	ALUMINIUM	2400	1
HEDDCS2400GO	GOLD	2400	1



## JOINERY SEALS

### E STRIP

#### CORE USE

- For all types of hinged doors and windows

#### MATERIAL

- Self adhesive EPDM rubber seal with a non stretch backing tape
- Bonds to any clean, dry surface
- Easily compressed

SEALS GAPS  
2-3.5 mm



PACKED IN A 5 METRE DISPLAY PACK

Code	Colour	Profile Size (mm)	Roll Length (m)	Pack Qty
HESSE05WH	WHITE	4 x 9	5	1
HESSE05BR	BROWN	4 x 9	5	1

### P STRIP

#### CORE USE

- For all types of hinged doors and windows

#### MATERIAL

- Self adhesive EPDM rubber seal with a non stretch backing tape
- Bonds to any clean, dry surface
- Easily compressed

SEALS GAPS  
2-5 mm



PACKED IN A 5 METRE DISPLAY PACK

Code	Colour	Profile Size (mm)	Roll Length (m)	Pack Qty
HESSP05WH	WHITE	5.5 x 9	5	1
HESSP05BR	BROWN	5.5 x 9	5	1

### V STRIP

#### CORE USE

- For all types of hinged doors and windows

#### MATERIAL

- Self adhesive EPDM rubber seal with a non stretch backing tape
- Bonds to any clean, dry surface
- Easily compressed

SEALS GAPS  
3-6.5 mm



PACKED IN A 5 METRE DISPLAY PACK

Code	Colour	Profile Size (mm)	Roll Length (m)	Pack Qty
HESSV05WH	WHITE	7 x 9	5	1
HESSV05BR	BROWN	7 x 9	5	1

### AQUATEX A10 WEATHERSEAL

#### CORE USE

- For timber doors and windows

#### MATERIAL

- Polyethylene UV stable skin
- Polyurethane memory foam core
- Polypropylene insert for stability and a secure fixing
- Does not propagate mould or mildew

SEALS GAPS  
5-9 mm



LIFE TIME GUARANTEE

Code	Colour	Roll Length (m)	Pack Qty
HEAQXA10006WH	WHITE	6	1
HEAQXA10250WH		250	1
HEAQXA10006BR	BROWN	6	1
HEAQXA10250BR		250	1

### SELF ADHESIVE FOAM

#### CORE USE

- An effective draught seal designed to fill gaps and stop rattles
- For all types of doors or windows

#### MATERIAL

- Bonds to any clean, dry surface

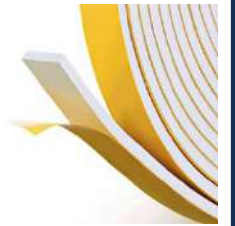

PACKED IN A EUROSLOTTED BAG FOR EASY MERCHANDISING

Code	Colour	Type	Size (mm)	Roll Length (m)	Pack Qty
HESAFS05WH	WHITE	Standard	4 x 6	5	1
HESAFS15WH		Standard	4 x 6	15	1
HESAFT05WH		Thick	8 x 8	5	1
HESAFS05BR	BROWN	Standard	4 x 6	5	1
HESAFS15BR		Standard	4 x 6	15	1
HESAFT05BR		Thick	8 x 8	5	1

### POLYPROPYLENE SELF ADHESIVE PILE

#### CORE USE

- An effective draught seal which allows sliding surfaces to move
- For all types of doors and windows sliding or hinged
- Stops rattles

#### MATERIAL

- A polypropylene self adhesive pile for bonding to any clean, dry surface
- Unaffected by moisture or temperature and will not rot easily



Code	Colour	Profile Size (mm)	Roll Length (m)	Pack Quantity
HESASP05WH	WHITE	5 x 7	5	1
HESASP05BR	BROWN	5 x 7	5	1

### THRESHOLD SEALING BAR

#### CORE USE

- Threshold with an integrated water sealing flipper/draught excluder
- Rout appropriate sized notch and fix product into groove
- 12mm projection when fitted

#### MATERIAL

- Has a rigid PVC body and flexible flipper



Code	Colour	Length (mm)	Pack Quantity
HETSB914BR	BROWN	914	1





## RETROFIT & ACCESSORIES

### ALUMINIUM LETTERPLATE SEAL WITH FLAP

#### CORE USE

- For horizontal letterboxes
- Stops draughts, dust and rain
- Flap not sprung

#### MATERIAL

- Aluminium letterplate with long lasting bristles

INTERNAL USE ONLY



Code	Colour	Size (mm)	Pack Qty
HELPSAFGO	GOLD	293 x 77	1
HELPSAFMI	SILVER	293 x 77	1

### PVC LETTERPLATE SEAL WITH FLAP

#### CORE USE

- For horizontal letterboxes
- Stops draughts, dust and rain
- Flap not sprung

#### MATERIAL

- Moulded high impact PVC with long lasting bristles

INTERNAL USE ONLY



Code	Colour	Size (mm)	Pack Qty
HELPSFWH	WHITE	343 x 80	1
HELPSFBR	BROWN	343 x 80	1

### PVC LETTERPLATE SEAL WITHOUT FLAP

#### CORE USE

- For horizontal or vertical letterboxes
- Stops draughts, dust and rain

#### MATERIAL

- Moulded high impact PVC with long lasting bristles

INTERNAL USE ONLY



Code	Colour	Size (mm)	Pack Qty
HELPSWH	WHITE	343 x 80	1
HELPSBR	BROWN	343 x 80	1

### BRUSH STRIPS

#### CORE USE

- Stops draughts, dust, noise, etc.
- Adjusts to irregular gaps and can be used over carpets

#### MATERIAL

- Hard wearing polypropylene bristles (18mm length)

DOMESTIC & INDUSTRIAL USE FOR ALL TYPES OF DOORS



Code	Colour	Size (mm)	Pack Qty
HEBRU220914MI	ALUMINIUM	914	1
HEBRU220914GO	GOLD	914	1
HEBRU220914BR	BROWN	914	1
HEBRU220914WH	WHITE	914	1

### GLAZING FILM

#### CORE USE

- Creates a secondary glazing effect on windows, reducing heating costs
- Reduces draughts and condensation

ECONOMICAL & EASY TO INSTALL



COMES COMPLETE WITH DOUBLE SIDED FIXING TAPE

Code	Colour	Size (m <sup>2</sup> )	Pack Qty
HEGF4500CL	CLEAR	4.5	1

### UNDER DOOR DRAUGHT EXCLUDER

#### CORE USE

- Used to improve energy efficiency by sealing gaps which allow outside air to enter

FITS MOST INTERNAL DOORS EASY TO CUT & INSTALL  
**SEALS GAPS: UP TO 22MM**



Code	Colour	Size (mm)	Pack Qty
HEUDDE0950	GREY	950	1

### RADIATOR FOIL

#### CORE USE

- Reflects warmth to increase heating effect
- A 5 metre roll covers 3 standard size radiators



EASY APPLICATION FITS ALL RADIATORS

Code	Colour	Size (m)	Pack Qty
HERADFOIL05005	SILVER	5 x 0.5	1

### INSULATING EXTERNAL TAP COVER

#### CORE USE

- Provides frost protection for outside taps
- Taps can be used with the cover left on



EASY TO INSTALL FITS MOST TAPS

Code	Colour	Pack Qty
HEINSTAP	GREY/GREEN	1





## ROTHLEY

## TUBE/RAIL & ACCESSORIES

### TUBE/RAIL

#### CORE USE

- Can fit a number of applications using our various bracket and socket accessories

CAN BE CUT TO SIZE  
BRACKETS OR SOCKETS  
WILL COVER ANY  
ROUGH EDGES

SHRINK WRAPPED & BARCODED



Code	Finish	Shape	Diameter (mm)	Length (mm)	Box Qty
HTTTH16CB0914	CHROME	Round	19	910	10
HTTTH16CB1219		Round	19	1200	10
HTTTH16CB1524		Round	19	1520	10
HTTTH16CB1829		Round	19	1830	10
HTTTH16CB2438		Round	19	2440	10
HTTTH29CB0914		Round	25	910	10
HTTTH29CB1219		Round	25	1200	10
HTTTH29CB1524		Round	25	1520	10
HTTTH29CB1829		Round	25	1830	10
HTTTH29CB2438		Round	25	2440	10
HTTTH29AC1219	ANTIQU COPPER	Round	25	1219	10
HTTTH29AC1829		Round	25	1830	10
HTTTH29Q51219	MATT BLACK	Round	25	1200	10
HTTTH29Q51829		Round	25	1830	10
HTTTH29Q52438		Round	25	2440	10
HTTTH58PA0914	WHITE	Round	25	910	10
HTTTH58PA1219		Round	25	1200	10
HTTTH58PA1524		Round	25	1520	10
HTTTH58PA1829		Round	25	1830	10
HTTTH58PA2438	Round	25	2440	10	
HTTTHA5CB1829	CHROME	Oval	30 x 15	1830	10



THE ROTHLEY RANGE OF MULTI-PURPOSE TUBE/RAIL CAN BE USED AS WARDROBE RAILS, UTENSIL RAILS OR CURTAIN RAILS

MIX & MATCH ANY OF THE TUBE/RAIL WITH TUBE ACCESSORIES OR CURTAIL RAIL ACCESSORIES

ALL TUBE/RAIL IS SHRINK WRAPPED & BARCODED

### TUBE ACCESSORIES

- Diecast deluxe/standard centre brackets, end brackets and end sockets
- Economical & easy to install

BAGGED, LABELLED & BARCODED  
SCREWS INCLUDED - 5 BAGS PER BOX

#### CENTRE BRACKETS

Mid support for longer lengths of tube preventing the tube from bending or breaking



DELUXE STANDARD OVAL

#### END BRACKETS

End support for tube being suspended



DELUXE STANDARD

#### END SOCKETS



OVAL

### CURTAIN RAIL ACCESSORIES

DESIGNED TO FIT ROTHLEY 25MM RAIL



Code	Finish	Description	Pack Qty
HTTC151BAC	ANTIQU COPPER	Curtain Rings	10
HTTC158BAC		Curtain Pole Bracket	1
HTTCB152BAC		Solid Orb Finials	2
HTTCB154BAC	Cage Orb Finials	2	
HTTC151BK	POLISHED SILVER	Curtain Rings	10
HTTC158BSM		Curtain Pole Bracket	1
HTTCB152BSP		Solid Orb Finials	2
HTTCB154BK	Cage Orb Finials	2	
HTTC151BV	MATT BLACK	Curtain Rings	10
HTTC158BV		Curtain Pole Bracket	1
HTTCB152BV		Solid Orb Finials	2
HTTCB154BV	Cage Orb Finials	2	
HTTC159BK	STEEL	Curtain Pole Extender	1

Code	Finish	Description	Size (mm)	Bag Qty	Box Qty
HTTFW16C0B100	CHROME	Deluxe End Bracket	19	2	5
HTTFW16C0B101		Deluxe Centre Bracket	19	1	5
HTTFW16C0B200		Standard End Bracket	19	2	5
HTTFW16C0B201		Standard Centre Bracket	19	1	5
HTTFW16C0B527		Super Deluxe End Socket	19	2	5
HTTFW16C1B625		Deluxe End Socket	19	2	5
HTTFW29C0B100		Deluxe End Bracket	25	2	5
HTTFW29C0B101		Deluxe Centre Bracket	25	1	5
HTTFW29C0B200		Standard End Bracket	25	2	5
HTTFW29C0B201		Standard Centre Bracket	25	1	5
HTTFW29C0B527	Super Deluxe End Socket	25	2	5	
HTTFW29C1B625	Deluxe End Socket	25	2	5	
HTTFW29ACB100	ANTIQU COPPER	Standard End Bracket	25	2	5
HTTFW29ACB101		Standard Centre Bracket	25	1	5
HTTFW29ACB627	Standard End Socket	25	2	5	
HTTFW29C0B100	WHITE	Deluxe End Bracket	25	2	5
HTTFW29Q0B101		Deluxe Centre Bracket	25	1	5
HTTFW29Q1B625	Deluxe End Socket	25	2	5	
HTTFW29Q5B100	MATT BLACK	Deluxe End Bracket	25	2	5
HTTFW29Q5B101		Deluxe Centre Bracket	25	1	5
HTTFW29Q5B627	Super Deluxe End Socket	25	2	5	
HTTFWXXC0B550	CHROME	Oval End Socket	30 x 15	2	5
HTTFWXXC0B661		Oval Centre Bracket	30 x 15	1	5

## KITCHEN WORKTOP TRIMS

### WORKTOP TRIMS

#### CORNER JOINT KITCHEN WORKTOP TRIM

##### MATERIAL

- High quality pre-drilled aluminium trims, available in a wide range of colours to suit most kitchen worktops
- Individually wrapped and bar coded



COMPLETE WITH FIXING SCREWS

Code	Colour	Height (mm)	Length (mm)	Pack Qty
HKWCJ030BG	BRIGHT GOLD	30	630	1
HKWCJ040BG		40	630	1
HKWCJ030BS	BRIGHT SILVER	30	630	1
HKWCJ040BS		40	630	1
HKWCJ030BL	BLACK	30	630	1
HKWCJ040BL		40	630	1
HKWCJ030MS	MATT SILVER	30	630	1
HKWCJ040MS		40	630	1

#### STRAIGHT JOINT KITCHEN WORKTOP TRIM



Code	Colour	Height (mm)	Length (mm)	Pack Qty
HKWSJ030BG	BRIGHT GOLD	30	630	1
HKWSJ040BG		40	630	1
HKWSJ030BS	BRIGHT SILVER	30	630	1
HKWSJ040BS		40	630	1
HKWSJ030BL	BLACK	30	630	1
HKWSJ040BL		40	630	1
HKWSJ030MS	MATT SILVER	30	630	1
HKWSJ040MS		40	630	1

#### END CAP KITCHEN WORKTOP TRIM



Code	Colour	Height (mm)	Length (mm)	Pack Qty
HKWEC030BG	BRIGHT GOLD	30	630	1
HKWEC040BG		40	630	1
HKWEC030BS	BRIGHT SILVER	30	630	1
HKWEC040BS		40	630	1
HKWEC030BL	BLACK	30	630	1
HKWEC040BL		40	630	1
HKWEC030MS	MATT SILVER	30	630	1
HKWEC040MS		40	630	1



**ROTHLEY**

## HANDRAILS & GRAB RAILS

### HANDRAIL KITS

#### CORE USE

- Everything required to fit a stylish and elegant 3.6m handrail

TESTED TO BS 6180:2011 - CLAUSE 6.4.1 FIRA INTERNATIONAL  
40MM RAIL DIAMETER  
PROVIDED IN AN EASY TO MERCHANDISE BOX WITH A WINDOW

KITS CONTAIN EVERYTHING YOU NEED TO INSTALL THE HANDRAIL: INSTRUCTIONS & FIXINGS INCLUDED



Code	Colour	Fittings Colour	Size (m)	Box Qty
HTHKDMB3600	DRIFTWOOD	Matt Black	3.6	1
HTHKEAB3600	EBONY	Antique Brass	3.6	1
HTHKODP3600	RED OAK	Brushed Silver	3.6	1
HTHKPDP3600	PINE WOOD	Brushed Silver	3.6	1



### GRAB RAILS

#### CORE USE

- Fixed when additional support required
- ABS ideal for external or bathroom use
- ABS grab rails have covers to conceal the fixings



ABS GRAB RAILS ARE TESTED TO BS EN 12182: 1999 SECTION 16.2

Code	Material	Finish	Dia. (mm)	Wall Clearance (mm)	Size	Box Qty
HTLGWBRQ10403	STEEL	White	25	70	18"/457mm	1
HTLGWBRQ10404		White	25	70	24"/610mm	1
HTLGWCKK30480	ABS PLASTIC	White	35	50	12"/305mm	1
HTLGWCKK30481		White	35	50	18"/457mm	1
HTLGWCKK30482		White	35	50	24"/610mm	1

### CONCEALED HINGE

#### CORE USE

- Concealed hinge for cabinets

PLATE PROVIDED BUT NO FIXINGS



Code	Finish	Opening Angle	Size (mm)	Pack Qty
HKHHC110Z	BZP	110°	35	10
HKHHC165Z		165°	35	10

### TUTCH LATCH

- Works on a 'push to latch, push to release' system
- The main body is fitted to the inner side of the cupboard and the striker plate is fitted to the inside of the door to line up with the catch



Code	Finish	Pack Qty
HKHTLZ	BZP	1

### MAGNETIC CATCH

#### CORE USE

- Creates a secure fastening using magnetic force to hold two objects together

FIXINGS NOT PROVIDED

The moulding holds the magnet and is fitted to the side of the cupboard. The metal striker plate is fitted to the back of the door so that the two parts line up.



Code	Colour	Type	To Pull Up To (kg)	Pack Qty
HKHMC01WH	WHITE	Single	4	100
HKHMC03WH		Double	6	50
HKHMC01BR	BROWN	Single	4	100
HKHMC03BR		Double	6	50

### KNOCKDOWN JOINT

#### CORE USE

- Ideal for joining sheet materials
- As the bolt is tightened, it draws the two fittings together

#### MATERIAL

- Plastic moulded blocks with a bolt passing through the first block into the thread of the second



FIXINGS NOT PROVIDED

Code	Colour	Pack Qty
HKHKDJWH	WHITE	100
HKHKDJBR	BROWN	100

### MORTICE ROLLER CATCH

- Adjustable tension by turn of a screwdriver

SUPPLIED WITH CLOSED KEEP

ROLLER NYLON



Code	Finish	Type	Pack Qty
HKHRCANP	NICKEL PLATED	Adjustable	10
HKHRCAEB	ELECTRO BRASSED	Adjustable	10

### MODESTY BLOCK

#### CORE USE

- For joining sheet materials and fitting modesty panels
- Gives stability when used to attach kitchen units to the underside of worktops

#### MATERIAL

- Plastic moulded block

SUITABLE FOR USE WITH COUNTERSUNK SCREWS



Code	Colour	Pack Qty
HKHMBWH	WHITE	100
HKHMBBR	BROWN	100

### BALES CATCH

Also known as a "ball catch".

#### CORE USE

- Creates a fastening allowing the door to be pulled open or pushed closed with ease



Code	Finish	Size	Pack Qty
HKHBC0625NP	NICKEL PLATED	5/8"	100
HKHBC0625EB	ELECTRO BRASSED	5/8"	100

### PVC DOOR STOP

#### MATERIAL

- Moulded plastic

FITTINGS NOT INCLUDED



Code	Colour	Size	Pack Qty
HKHDS1125WH	WHITE	1 1/8"	250
HKHDS1125BL	BLACK	1 1/8"	250

### DOUBLE ROLLER CATCH

#### CORE USE

- Provides a smooth tight grip action that fastens cabinet doors securely

Roller assembly with two rollers which open up as the clip is pushed into it as the door is closed



Code	Finish	Pack Qty
HKHRCDZ	BZP	100

### WORKTOP CONNECTING BOLTS/CLAMPS

#### CORE USE

- Eliminates the need for surface mounted worktop joining strips
- The bolts are set underneath the 2 panels/worktops in a dogbone jig

COMPRISES  
1 X 150MM BOLT  
1 X TIGHTENING NUT  
2 X CURVED CAPS



Code	Finish	Size (mm)	Pack Qty
HKHCBZ150	BZP	150	10
HKHCBZB150		150	250



## FLOORING TRIMS

### CORE USE







- Ideal for edging or joining carpets, tiles and vinyls in doorways around the office and home

### MATERIAL

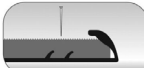
- High quality aluminium
- Bright silver trims are highly polished
- Bright gold trims are anodised

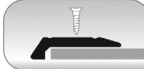

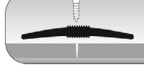
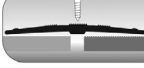
PROVIDED INDIVIDUALLY WRAPPED WITH BARCODE & COMPLETE WITH FIXINGS FOR EASY FITTING

Code	Colour	Type	Size (mm)	Pack Qty	Description	Profile
HKFSN0900G	GOLD	Single Nap	900	1	Designed to give a neat finish to the edge of a carpet where the adjoining floor is solid (e.g. vinyl or tile).	
HKFSN0900S	SILVER					
HKFTG0900G	GOLD	Twin Grip	900	1	Designed to finish the joint between two carpets (not foam backed).	
HKFTG0900S	SILVER					
HKFCC0900G	GOLD	Carpet Cover	900	1	Designed to cover the joint between two carpets/doorways. The teeth on the trim dig in to ensure the carpet stays in place.	
HKFCC0900S	SILVER					
HKFVE0900G	GOLD	Vinyl Edge	900	1	Designed to edge vinyl and tiles. Used where there is a difference in heights up to 4mm.	
HKFVE0900S	SILVER					
HKFVC0900G	GOLD	Vinyl Cover	900	1	A cover strip used to cover the joint between two hard floor coverings (e.g. vinyl) of the same height.	
HKFVC0900S	SILVER					
HKFNC0900G	GOLD	Narrow Cover Strip	900	1	A narrow vinyl cover strip with an unobtrusive profile for covering the joint between two hard floor coverings of equal height.	
HKFNC0900S	SILVER					
HKFWC0900G	GOLD	Wide Cover Plate	900	1	Designed to cover the joint between any two floor coverings. Ideal for covering frayed or damaged carpet edges and gaps between floor coverings.	
HKFWC0900S	SILVER					
HKFTLC0900G	GOLD	Curved Laminate	900	1	Fits over the edge of the laminate and provides a smooth transition down to the adjacent resilient flooring.	
HKFTLC0900S	SILVER					
HKFLC0900G	GOLD	Laminate to Carpet	900	1	Designed to join laminate floor or ceramic tiles to carpet allowing for a height variance of up to 9mm.	
HKFLC0900S	SILVER					

## ROTHLEY SHEETS

DURABLE & EASY TO FIT

IDEAL FOR REINFORCEMENT, PROTECTION OR DECORATION

CAN PROVIDE **PROTECTION** TO PREVENT WEATHER DAMAGE OR OBSTRUCTIONS FORMING

CAN CREATE **DESIGN ACCENTS** AROUND THE KITCHEN AS PROVIDING PROTECTION FOR GRANITE, MARBLE OR WOODEN WORKTOP SURFACES

PROFILES ARE AVAILABLE TO MATCH SELECTED SHEETS: COMBINE THE TWO FOR MAXIMUM PROTECTION AND A CO-ORDINATED APPEARANCE

## SHEETS

### ALUMINIUM

Code	Type	Size (mm)	Pack Qty
HTSRK37000ASH	FLAT RAW	120 x 1000 x 0.8	1
HTSRK37002ASH		300 x 1000 x 0.8	1
HTSRK37003ASH		600 x 1000 x 0.8	1
HTSRK37004ASH		250 x 500 x 0.8	1
HTSRK37554ASH	CHECKER RAW	250 x 500 x 1.5	1
HTSRK37150ASH		120 x 1000 x 1.5	1
HTSRK37152ASH		300 x 1000 x 1.5	1
HTSRK37153ASH		600 x 1000 x 1.5	1
HTSRK37154ASH	PERFORATED ANODISED	250 x 500 x 1.5	1
HTSRK37361ASH		200 x 1000 x 1.5	1

### STEEL

Code	Type	Size (mm)	Pack Qty
HTSRK37602SSH	PERFORATED RAW	300 x 1000 (6 x 3.5 mesh)	1
HTSRK37604SSH		250 x 500 (6 x 3.5 mesh)	1
HTSRK37654SSH		250 x 500 (10 x 5.8 mesh)	1
HTSRK37704SSH		250 x 500 (16 x 8 mesh)	1
HTSRK38050SSH	FLAT GALVANISED	120 x 1000 x 0.5	1
HTSRK38051SSH		200 x 1000 x 0.5	1
HTSRK38054SSH		250 x 500 x 0.75	1
HTSRK38103SSH	FLAT RAW	600 x 1000 x 0.75	1
HTSRK38104SSH		250 x 500 x 0.75	1



## ROTHLEY PROFILES

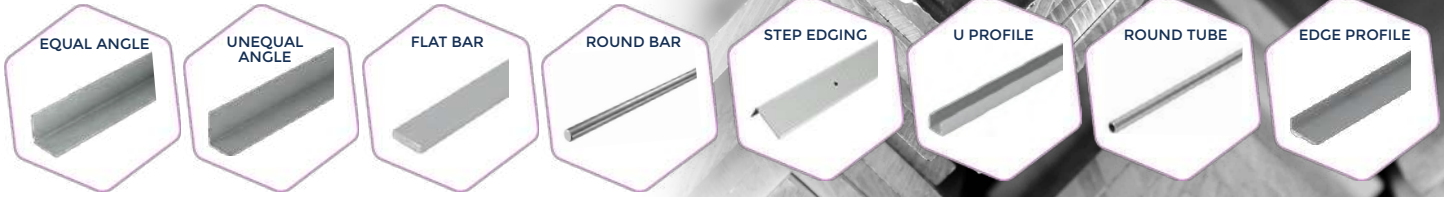

IDEAL FOR AN UPCYCLING PROJECT, ENHANCING & ELONGATING THE LIFE OF FURNITURE

### MATERIAL

MADE FROM DURABLE, HIGH-GRADE, NON-TOXIC MATERIALS, IN LINE WITH A NO CHROME PHILOSOPHY

### SUSTAINABILITY

PLASTIC AND PACKAGING KEPT TO A MINIMUM

### PVC PROFILES

Code	Type	Colour	Size (mm)	Length (m)	Pack Qty	
HTPRK11140P10	Equal Angle	BLACK	10x10	1	5	
HTPRK11141P10	Equal Angle		15x15	1	5	
HTPRK11142P10	Equal Angle		20x20	1	5	
HTPRK12140P10	Equal Angle	WHITE	10x10x1	1	5	
HTPRK12141P10	Equal Angle		15x15x1.2	1	5	
HTPRK12143P10	Equal Angle		25x25x1.8	1	5	
HTPRK12146P10	Equal Angle		20x20x1	1	5	
HTPRK12147P10	Equal Angle		25x25x1	1	5	
HTPRK16140P20	Equal Angle		10x10x1	2	5	
HTPRK16141P20	Equal Angle		15x15x1.2	2	5	
HTPRK16142P20	Equal Angle		20x20x1.5	2	5	
HTPRK16143P20	Equal Angle		25x25x1.8	2	5	
HTPRK16573P25	Equal Angle		20x20	2.5	5	
HTPRK16574P25	Equal Angle		25x25	2.5	5	
HTPRK12150P10	Unequal Angle		WHITE	20x10	1	5
HTPRK12151P10	Unequal Angle			25x20	1	5
HTPRK12152P10	Unequal Angle			30x20	1	5
HTPRK16150P20	Unequal Angle			20x10	2	5
HTPRK16151P20	Unequal Angle	25x20		2	5	
HTPRK21686P10	Unequal Angle	15.5x27.5		1	5	
HTPRK21688P10	Unequal Angle	19.5x35.5		1	5	
HTPBE21846P10	Flat Bar	BRONZE		15.5x2	1	5
HTPBE21850P10	Flat Bar			23.5x2	1	5
HTPCE21846P10	Flat Bar			CHROME	15.5x2	1
HTPCE21850P10	Flat Bar	23.5x2			1	5
HTPDG21846P10	Flat Bar	DARK GRANITE			15.5x2	1
HTPDG21850P10	Flat Bar			23.5x2	1	5
HTPRK16611P25	Adhesive Angle			WHITE	15x15	2.5
HTPRK16612P25	Adhesive Angle	20x20			2.5	5
HTPRK12612P10	Adhesive Angle	20x20	1		5	
HTPRK12615P10	Adhesive Angle	INOX	20x20		1	5
HTPRK12616P10	Adhesive Angle	OAK	20x20		1	5
HTPRK21444P10	U Profile	WHITE	11.5x11.5x1.5	1	5	

### STEEL PROFILES

Code	Type	Finish	Size (mm)	Length (m)	Pack Qty
HTPRK39402S10	Equal Angle	GALV	23.5x23.5x1.2	1	5
HTPRK39403S10	Equal Angle		35.5x35.5x1.5	1	5
HTPRK39422S25	Equal Angle		23.5x23.5x1.2	2.5	5
HTPRK39011S10	Equal A. Drilled		23.5x23.5	1	5
HTPRK39010S25	Equal A. Drilled		35.5x35.5	2.5	5
HTPRK39400S10	Flat Bar		35.5x1.2	1	5
HTPRK39406S10	Flat Bar		23.5x1.2	1	5
HTPRK39013S10	Flat Bar Drilled		23.5	1	5
HTPRK34443S10	Ribbed Rod		6 (dia.)	1	5
HTPRK34444S10	Ribbed Rod		8 (dia.)	1	5

### ANODISED ALUMINIUM PROFILES

Code	Type	Colour	Size (mm)	Length (m)	Pack Qty
HTPRG05041A20	Equal Angle	ROSE GOLD	15x15	2	5
HTPRG05043A20	Equal Angle		20x20	2	5
HTPRG05043A20	Equal Angle		25x25	2	5
HTPRK01041A10	Equal Angle	SILVER	15x15	1	5
HTPRK01044A10	Equal Angle		30x30	1	5
HTPRK01241A10	Equal Angle	CHROME	15x15	1	5
HTPRK02241A10	Equal Angle	ST. STEEL	15x15	1	5
HTPRK05041A20	Equal Angle	SILVER	15x15	2	5
HTPRK05042A20	Equal Angle		20x20	2	5
HTPRK05043A20	Equal Angle		25x25	2	5
HTPSB05041A20	Equal Angle	ICE SILVER	15x15	2	5
HTPSB05042A20	Equal Angle		20x20	2	5
HTPSB05043A20	Equal Angle	25x25	2	5	
HTPRK01051A10	Unequal Angle	SILVER	25x20	1	5
HTPRK05054A20	Unequal Angle		35x20	1	5
HTPRK01011A10	Flat Bar	SILVER	20x1	1	5
HTPRK01013A10	Flat Bar		15x2	1	5
HTPRK01210A10	Flat Bar	CHROME	20x2	1	5
HTPRK02210A10	Flat Bar	ST. STEEL	20x2	1	5
HTPRK05012A20	Flat Bar	SILVER	25x2	2	5
HTPRK01033A10	Round Bar	SILVER	4 (dia.)	1	5
HTPRK01021A10	Round Tube	SILVER	8x1	1	5
HTPRK01022A10	Round Tube		10x1	1	5
HTPRK01023A10	Round Tube		12x1	1	5
HTPRK01401A10	Edge Profile	SILVER	19x8	1	5
HTPRK01402A10	Edge Profile		14x10	1	5
HTPRK05401A20	Edge Profile		19x8	2	5
HTPRK05452A20	Step Edging		41x23	2	5
HTPRK01060A10	U Profile		SILVER	10x11.5	1

### RAW ALUMINIUM PROFILES

Code	Type	Size (mm)	Length (m)	Pack Qty
HTPRK25564A10	Equal Angle	11.5x11.5x1.5	1	5
HTPRK25566A10	Equal Angle	15.5x15.5x1.5	1	5
HTPRK25568A10	Equal Angle	19.5x19.5x1.5	1	5
HTPRK25570A10	Equal Angle	23.5x23.5x1.5	1	5
HTPRK25584A25	Equal Angle	11.5x11.5x1.5	2.5	5
HTPRK25586A25	Equal Angle	15.5x15.5x1.5	2.5	5
HTPRK25588A25	Equal Angle	19.5x19.5x1.5	2.5	5
HTPRK27840A10	Checker Angle	23.5x23.5x1.5/2	1	5
HTPRK27841A25	Checker Angle	23.5x23.5x1.5/2	2.5	5
HTPRK27850A10	Checker Angle	29.5x29.5x1.5/2	1	5
HTPRK25644A10	Unequal Angle	11.5x19.5x1.5	1	5
HTPRK25646A10	Unequal Angle	15.5x27.5x1.5	1	5
HTPRK25648A10	Unequal Angle	19.5x35.5x1.5	1	5
HTPRK25650A10	Unequal Angle	23.5x43.5x1.5	1	5
HTPRK27890A10	Checker Unequal	23.5x43.5x1.5/2	1	5
HTPRK27891A25	Checker Unequal	43.5x23.5x1.5/2	2.5	5
HTPRK25808A10	Flat Bar	19.5x2	1	5
HTPRK25808A10	Flat Bar	23.5x2	1	5
HTPRK25006A10	Round Tube	15.5x1.5	1	5
HTPRK25406A10	U Profile	15.5x15.5x1.5	1	5
HTPRK25408A10	U Profile	19.5x19.5x1.5	1	5

## INTUMESCENT STRIPS

### CORE USE

#### FIRE ONLY STRIP

- Contains a graphite core which expands with heat to seal gap between the door and the frame, thereby stalling the spread of fire

#### FIRE & SMOKE STRIP

- Includes a brush along the full length of it which slows down the spread of smoke until the heat of the fire causes the intumescent strip to expand and seal the gap

### MATERIAL

- Self adhesive but also needs to be rebated into either the door frame or door edge
- In order to fit the correct size strip, check the door manufacturers' instructions, usually 10mm on existing FD30 doors and 15mm on all new 30 minute fire doors

FIRE ONLY



FIRE & SMOKE



SUPPLIED WITH FITTING INSTRUCTIONS

Code	Type	Colour	Size (mm)	Fire Rating (min)	Pack Qty
HAISSFO210010B	Fire Only	BROWN	2100 x 10	30	50
HAISSFO210015B		BROWN	2100 x 15	30	25
HAISSFO210020B		BROWN	2100 x 20	60	25
HAISSFO210010W		WHITE	2100 x 10	30	50
HAISSFO210015W		WHITE	2100 x 15	30	25
HAISSFO210020W	WHITE	2100 x 20	60	25	
HAISSFS210010B	Fire & Smoke	BROWN	2100 x 10	30	50
HAISSFS210015B		BROWN	2100 x 15	30	25
HAISSFS210020B		BROWN	2100 x 20	60	25
HAISSFS210010W		WHITE	2100 x 10	30	50
HAISSFS210015W		WHITE	2100 x 15	30	25
HAISSFS210020W	WHITE	2100 x 20	60	25	

## INTUMESCENT STRIP DOORPACKS

### CORE USE

- Intumescent strip doorpacks including 2 x 2100mm strips and 1 x 1050mm - ready for use on a door

#### FIRE ONLY STRIP

- Contains a graphite core which expands with heat to seal gap between the door and the frame, thereby stalling the spread of fire

#### FIRE & SMOKE STRIP

- Includes a brush along the full length of it which slows down the spread of smoke until the heat of the fire causes the intumescent strip to expand and seal the gap

FIRE ONLY



FIRE & SMOKE



SUPPLIED WITH FITTING INSTRUCTIONS

Code	Type	Colour	Size (mm)	Fire Rating (mins)
HAISSPFO210010B	Fire Only	BROWN	2100 x 10	30
HAISSPFO210015B		BROWN	2100 x 15	30
HAISSPFO210010W		WHITE	2100 x 10	30
HAISSPFO210015W		WHITE	2100 x 15	30
HAISSPFS210010B	Fire & Smoke	BROWN	2100 x 10	30
HAISSPFS210015B		BROWN	2100 x 15	30
HAISSPFS210010W		WHITE	2100 x 10	30
HAISSPFS210015W		WHITE	2100 x 15	30

## SURFACE MOUNTED INTUMESCENT STRIPS

### CORE USE

- In the event of fire, the strips expand preventing the fire from spreading
- Speedy to install as no routing of door or frame required

FIRE TESTED FOR 30 MINS TO BS476: PART 22



SELF-ADHESIVE  
COLOUR CODED BRUSH  
PILE HEIGHT: 5MM  
(SUITABLE FOR 3-5MM GAPS)

Code	Colour	Thickness (mm)	Size (mm)	Fire Rating (min)	Pack Qty
HAISSMFS5200B	BROWN	1.8	5200 x 25	30	1
HAISSMFS5200C	GREY	1.8	5200 x 25	30	1
HAISSMFS5200OAK	OAK	1.8	5200 x 25	30	1
HAISSMFS5200W	WHITE	1.8	5200 x 25	30	1

## DROPDOWN SEALS

### CORE USE

- For all types of swing doors
- Fitted along the bottom of a door - once the door closes, the seal drops down and covers the gap underneath the door and reduces the risk of smoke passing through

FIRE TESTED FOR 30 & 60 MINS TO BS 476: PART 22

SMOKE TESTED TO BS EN 1634-3: 2001

ACOUSTIC TESTED UP TO 43DB TO BS EN ISO 10140-2:2010



Code	Material	Size (mm)	Pack Qty
HAICON930SAA	Satin Anodised Aluminium (SAA)	930	1

## INTUMESCENT LETTERBOXES

### MATERIAL

- ABS framed telescopic letterbox fitted with a high performance intumescent liner
- Adjustable: 40-80mm

FIRE TESTED FOR 30 MINS TO BS476 PART 22: 1987

SMOKE TESTED TO BS476 PART 31.1 1983

ACOUSTIC TESTED ACHIEVING 32RW DB

SUPPLIED WITH INSTALLATION INSTRUCTIONS



Code	Finish	Size (mm)	Pack Qty
HAIL250BLGOL	BLACK/POLISHED GOLD	250 x 70	1
HAIL300BLGOL		300 x 70	1
HAIL250BLPCP	BLACK/CHROME	250 x 70	1
HAIL300BLPCP		300 x 70	1
HAIL250BLSAA	BLACK/SATIN ANODISED ALUMINIUM	250 x 70	1
HAIL300BLSAA		300 x 70	1
HAIL250BLSIL	BLACK/POLISHED SILVER	250 x 70	1
HAIL300BLSIL		300 x 70	1
HAIL250BLSSS	SILVER/STAINLESS STEEL	250 x 70	1
HAIL300BLSSS		300 x 70	1

## INTUMESCENT AIR TRANSFER VENTS

### CORE USE

- Suitable for use in fire resisting doorsets and compartment walls
- In the event of a fire, the vent closes and provides a barrier to restrict the passage of hot gases
- The vents expand to form a solid block

ROBUST  
NON-FLAKING  
DIFFICULT TO TEAR  
**FIRE TASTED FOR 60 MINS**



SUPPLIED WITH INSTALLATION INSTRUCTIONS

Code	Finish	Size (mm)	Free Air Flow (cm <sup>2</sup> )	Pack Qty
HAIATV150150	GALVANISED	150x150	153	1
HAIATV225112		225x112	161	1
HAIATV225225		225x225	323	1
HAIATV300150		300x150	307	1
HAIATV300300		300x300	614	1

## INTUMESCENT GRILLES

### CORE USE

- Face plate for air transfer vents
- Grilles contain no moving parts which results in low maintenance



SUPPLIED WITH FIXING SCREWS

Code	Finish	Size (mm)	Free Air Flow (cm <sup>2</sup> )	Pack Qty
HAIG150150SIL	SILVER	150x150	150	1
HAIG225112SIL		225x112	159	1
HAIG225225SIL		225x225	320	1
HAIG300150SIL		300x150	295	1
HAIG300300SIL		300x300	593	1

## INTUMESCENT HINGE PADS & SHEETS

### CORE USE

- Pads sit behind hinges and offer additional protection in the event of fire
- Sheets are ideal for locks, latches or door closers

### MATERIAL

- Pads are self-adhesive on one side and a universal fit for 100mm fire rated hinges
- Sheets can be cut to size

FIRE RATED TO 60 MINS  
FD60 COMPLIANCE



Code	Description	Size (mm)	Fire Rating (mins)	Pack Qty	Outer Qty
HAIHP10031	Pads	100 x 31	60	100	1
HAIHP10031	Pads	100 x 31	60	6	10
HAIPS200200	Sheets	200 x 200	60	1	10

## INTUMESCENT LOCK KITS

### CORE USE

- Protects ironmongery installed on fire doors without compromising the integrity of the fire door assembly
- BS DEADLOCK - universal BS Deadlock Kit to suit 64/76mm backset C/W Strike Plate
- BS SASHLOCK - universal BS Sashlock Kit to suit 64/76mm backset C/W Strike Plate
- DIN STANDARD LOCK - universal DIN Lock Kit to suit 55/60 backset C/W Strike Plate

### MATERIAL

- Manufactured from a high performance 1mm flexible intumescent graphite

PACKED IN A EUROSLOTTED BOX FOR EASY MERCHANDISING

FIRE TESTED FOR 30 & 60 MINS TO BS 476-22

### FOR BS DEADLOCK



### FOR BS SASHLOCK



### FOR DIN STANDARD LOCK



Code	For Lock Type	Pack Qty
HAIPBSDLK	BS Deadlock	1
HAIPBSSLK	BS Sashlock	1
HAIPDINLK	DIN Standard Lock	1

## INTUMESCENT PACKERS

### CORE USE

- Fire rated packers

### MATERIAL

- Packers are colour coded for 3 different thicknesses

FIRE TESTED FOR 30 & 60 MINS TO BS EN 1634-1 AND BS 476-22



Code	Colour	Size (mm)	Thickness (mm)	Pack Qty
HAIPACK0151001G	GREEN	15 x 100	1	100
HAIPACK0151003W	WHITE	15 x 100	3	100
HAIPACK0151005B	BLUE	15 x 100	5	100



## ROTHLEY HOOKS & HANGERS

**IDEAL FOR**  
KITCHEN, GARAGE & SHED STORAGE  
TO MAXIMISE SPACE

**DESIGN**  
ENSURES STORED ITEMS ARE  
PROTECTED FROM BEING SCRATCHED

**MERCHANDISING**  
MOST ITEMS ARE BARCODED AND EITHER LABELLED  
AND/OR BAGGED FOR EASY MERCHANDISING

### LIGHT & MEDIUM HOOKS



Code	Description	Colour	Max. Load (kg)	Size (mm)	Box Qty
HTGHQYYH10345	S Hook	BLACK & RED	10	200	10
HTGHQYYH10349	S Hook		10	400	10
HTGHQYYH10352	Tubular Hook		15	70	10
HTGHQYYH10353	Tubular Hook		15	150	10
HTGHQYYH10354	Tubular Hook		15	190	10
HTGHQYYH10373	Tubular Hook		15	280	20
HTGHQYYH10357	Double Tubular Hook		20	70	10
HTGHQYYH10355	Double Tubular Hook		20	120	10
HTGHQYYH10356	Double Tubular Hook		20	220	10
HTGHQYYH10379	Handy Hook		20	110	10 Prs
HTGHQYYH10380	Hang All Bracket	34	300	10	



Code	Description	Finish	Pack Qty	Outer Qty
HTGHQYYH10368	Spring Clip	BZP	1	10
HTGHQYYH10369	Broom Holder with Vinyl Coating	BZP/WHITE	1	10
HTGHQYYH10370	Double Tool Storage Hook	BZP	2	10



**THREAD**  
COARSE, SELF-TAPPING FOR EASY APPLICATION

Code	Description	Finish	Max. Load (kg)	Size (mm)	Pack Qty	Outer Qty
HTGHQYYH10362	Screw in Round Hooks	RED VINYL	10	95	2	10
HTGHQYYH10363	Screw in Round Hooks		15	100	2	10
HTGHQYYH10364	Screw in Tool Hooks		10	95	2	10
HTGHQYYH10365	Screw in Square Hooks		15	115	2	10

### STORAGE & UTILITY HOOKS



Code	Description	Material	Max. Load (kg)	Size (mm)	Pack Qty
HTGRK01908AHO	Wall & Ceiling Hook	ALUMINIUM	35	110 x 165	2
HTGRK01901AHO	Wall Hook		15	80 x 175	2
HTGRK01902AHO	Wall Hook		20	80 x 230	2
HTGRK02956SHO	Wall Hook	STEEL	80	80	2
HTGRK02959SHO	Wall Hook		60	115	2
HTGRK02962SHO	Wall Hook		85	150	2
HTGRK02965SHO	Wall Hook		40	250	2
HTGRK02968SHO	Double Wall Hook		120	90	2
HTGRK02969SHO	Double Wall Hook	80	175	2	

### HEAVY DUTY STORAGE HOOKS



Code	Description	Max. Load (kg)	Projection (mm)	Pack Qty
HTGHQYYH10358	Tubular Hook	22.7	300	10
HTGHQYYH10359	Tubular Swivel Hanger	22.7	300	10
HTGHQYYH10360	Tubular Ceiling Mount Hook	22.7	280	10
HTGHQYYH10361	Tubular Double Hook	34	280	5

### BIKE STORAGE

**FOLDING BIKE HOOK**  
FOLDS AGAINST THE WALL WHEN NOT IN USE

**SINGLE CURVED HOOK**  
NON-SLIP, RED SLEEVE FOR SCRATCH PREVENTION



Code	Description	Material	Max. Load (kg)	Size (mm)	Pack Qty
HTGHQYYH10382	Folding Bike Hook	STEEL	300	510 x 520	8
HTGHQYYH10384	Single Curved Hook		200	100 x 175	10



## GATEPRO

### GATEPRO PREPACKED IRONMONGERY

HINGES, BOLTS, LOCKS & SUNDRIES PROVIDED IN STRONG, EASY TO MERCHANDISE PACKAGING!

-  **BUILT TO LAST**
-  **EASY TO FIT**
-  **COMPLETE WITH ALL FIXINGS**

## PREPACKED HINGES

MOST OF THE RANGE IS PACKED IN OUR **GATEPRO POUCHES** - THESE ARE RE-SEALABLE AND EURO-SLOTTED

THE **REINFORCED GUSSET** IN THE BOTTOM MAKES THE POUCH STRONGER AND ENABLES IT TO SIT UPRIGHT ON A SHELF

OUR TEE HINGES ARE PROVIDED IN **GATEPRO EURO-SLOTTED CLAMS** - EASY TO HANG & ENABLE THE HINGES TO BE SEEN AND HANDLED





OUR HEAVY REVERSIBLE HINGES AND HOOKS & BANDS ARE PROVIDED IN **STRONG CLEAR BAGS** TO SIT ON THE SHELF





### 1838 BUTT HINGE | LIGHT

	Finish	Size	Size (mm)		
				BAG Qty	Outer Qty
H5H1838Z300	BZP	3" x 2"	75	1 Pr	5 Bags
H5H1838Z400		4" x 3"	100	1 Pr	5 Bags

### 451 BUTT HINGE | STRONG

	Finish	Size	Size (mm)		
				BAG Qty	Outer Qty
H5H451Z300	BZP	3" x 2"	75	1 Pr	5 Bags
H5H451Z400		4" x 3"	100	1 Pr	5 Bags

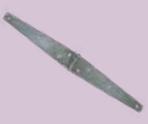
### 950 STRAP HINGE

	Finish	Size	Size (mm)		
				BAG Qty	Outer Qty
H5H950Z040	BZP	4"	100	1 Pr	5 Bags
H5H950Z060		6"	150	1 Pr	5 Bags
H5H950Z080		8"	200	1 Pr	5 Bags
H5H950Z100		10"	250	1 Pr	5 Bags
H5H950Z120		12"	300	1 Pr	5 Bags

### 868 WEIGHTY SCOTCH TEE HINGE

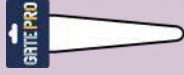
	Finish	Size	Size (mm)		
				CLAM Qty	Outer Qty
H5H868G120	GALV	12"	300	1 Pr	5 Clams
H5H868G140		14"	350	1 Pr	5 Clams
H5H868G160		16"	400	1 Pr	5 Clams
H5H868G180		18"	450	1 Pr	5 Clams
H5H868G240		24"	600	1 Pr	2 Clams

### 121A LIGHT TEE HINGE

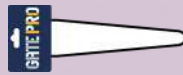
	Finish	Size	Size (mm)		
				CLAM Qty	Outer Qty
H5H121AB040	EPOXY BLACK	4"	100	1 Pr	5 Clams
H5H121AB060		6"	150	1 Pr	5 Clams
H5H121AB090		9"	230	1 Pr	5 Clams
H5H121AB120		12"	300	1 Pr	5 Clams
H5H121AZ040	BZP	4"	100	1 Pr	5 Clams
H5H121AZ060		6"	150	1 Pr	5 Clams
H5H121AZ090		9"	230	1 Pr	5 Clams
H5H121AZ120		12"	300	1 Pr	5 Clams

### 121 MEDIUM TEE HINGE

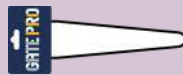
	Finish	Size	Size (mm)		
				CLAM Qty	Outer Qty
H5H121G120	GALV	12"	300	1 Pr	5 Clams
H5H121G140		14"	350	1 Pr	5 Clams
H5H121G150		15"	375	1 Pr	5 Clams
H5H121G160		16"	400	1 Pr	5 Clams
H5H121G180		18"	450	1 Pr	5 Clams
H5H121G240		24"	600	1 Pr	2 Clams
H5H121B120	EPOXY BLACK	12"	300	1 Pr	5 Clams
H5H121B140		14"	350	1 Pr	5 Clams
H5H121B150		15"	375	1 Pr	5 Clams
H5H121B160		16"	400	1 Pr	5 Clams
H5H121B180	BZP	18"	450	1 Pr	5 Clams
H5H121B240		24"	600	1 Pr	2 Clams
H5H121Z120		12"	300	1 Pr	5 Clams
H5H121Z140		14"	350	1 Pr	5 Clams
H5H121Z150	BZP	15"	375	1 Pr	5 Clams
H5H121Z160		16"	400	1 Pr	5 Clams
H5H121Z180		18"	450	1 Pr	5 Clams
H5H121Z240		24"	600	1 Pr	2 Clams

**499 HEAVY REVERSIBLE HINGE**

Image	Finish	Size	Size (mm)	Quantity	
				BAG Qty	Outer Qty
	GALV	12"	300	1 Pr	1 Bag
		14"	350	1 Pr	1 Bag
		16"	400	1 Pr	1 Bag
		18"	450	1 Pr	1 Bag
		24"	600	1 Pr	1 Bag
		30"	750	1 Pr	1 Bag
	EPOXY BLACK	36"	900	1 Pr	1 Bag
		12"	300	1 Pr	1 Bag
		14"	350	1 Pr	1 Bag
		16"	400	1 Pr	1 Bag
		18"	450	1 Pr	1 Bag
		24"	600	1 Pr	1 Bag
	EPOXY BLACK	30"	750	1 Pr	1 Bag
		36"	900	1 Pr	1 Bag

**PREPACKED  
HOOKS & BANDS  
HEAVY REVERSIBLE HINGES**

**1057 HOOK & BAND | ADJUSTABLE**

Image	Finish	Size	Size (mm)	Quantity	
				BAG Qty	Outer Qty
	GALV	12"	300	1 Pr	1 Bag
		18"	450	1 Pr	1 Bag
		24"	600	1 Pr	1 Bag
		30"	750	1 Pr	1 Bag
		36"	900	1 Pr	1 Bag

**1058 CURVED HINGE RAIL SET**

Image	Finish	Type	Size	Size (mm)	Quantity	
					BAG Qty	Outer Qty
	GALV	Left Hand	12"	300	1 Set	5 Bags
		Right Hand	12"	300	1 Set	5 Bags
	EPOXY BLACK	Left Hand	12"	300	1 Set	5 Bags
		Right Hand	12"	300	1 Set	5 Bags

**1055 HOOK & BAND | STRAIGHT**

Image	Finish	Size	Size (mm)	Quantity	
				BAG Qty	Outer Qty
	GALV	12"	300	1 Pr	1 Bag
		14"	350	1 Pr	1 Bag
		16"	400	1 Pr	1 Bag
		18"	450	1 Pr	1 Bag
		24"	600	1 Pr	1 Bag
		30"	750	1 Pr	1 Bag
	EPOXY BLACK	36"	900	1 Pr	1 Bag
		12"	300	1 Pr	1 Bag
		14"	350	1 Pr	1 Bag
		16"	400	1 Pr	1 Bag
		18"	450	1 Pr	1 Bag
		24"	600	1 Pr	1 Bag
	EPOXY BLACK	30"	750	1 Pr	1 Bag
		36"	900	1 Pr	1 Bag

**PREPACKED  
BOLTS**

**923A STRAIGHT TOWER BOLT**

Image	Finish	Size	Size (mm)	Quantity	
				BAG Qty	Outer Qty
	GALV	4"	100	1no	5 Bags
		6"	150	1no	5 Bags
		8"	200	1no	5 Bags
	EPOXY BLACK	3"	75	1no	5 Bags
		4"	100	1no	5 Bags
		6"	150	1no	5 Bags
	BZP	8"	200	1no	5 Bags
		3"	75	1no	5 Bags
		4"	100	1no	5 Bags
		6"	150	1no	5 Bags
		8"	200	1no	5 Bags

**1056 HOOK & BAND | CRANKED**

Image	Finish	Size	Size (mm)	Quantity	
				BAG Qty	Outer Qty
	GALV	12"	300	1 Pr	1 Bag
		14"	350	1 Pr	1 Bag
		16"	400	1 Pr	1 Bag
		18"	450	1 Pr	1 Bag
		24"	600	1 Pr	1 Bag
		30"	750	1 Pr	1 Bag
	EPOXY BLACK	36"	900	1 Pr	1 Bag
		12"	300	1 Pr	1 Bag
		14"	350	1 Pr	1 Bag
		16"	400	1 Pr	1 Bag
		18"	450	1 Pr	1 Bag
		24"	600	1 Pr	1 Bag
	EPOXY BLACK	30"	750	1 Pr	1 Bag
		36"	900	1 Pr	1 Bag

**923N NECKED TOWER BOLT**

Image	Finish	Size	Size (mm)	Quantity	
				BAG Qty	Outer Qty
	GALV	6"	150	1no	5 Bags
	EPOXY BLK	6"	150	1no	5 Bags
	BZP	6"	150	1no	5 Bags

## PREPACKED LATCHES

### 2A BRENTON PADBOLT

	Finish	Size	Size (mm)	GATE PRO	
				BAG Qty	Outer Qty
	GALV	4"	100	1no	5 Bags
H5D2AG0650		6"	150	1no	5 Bags
H5D2AG0850		8"	200	1no	5 Bags
H5D2AB0450	EPOXY BLACK	4"	100	1no	5 Bags
H5D2AB0650		6"	150	1no	5 Bags
H5D2AB0850	BZP	8"	200	1no	5 Bags
H5D2AZ0450		4"	100	1no	5 Bags
H5D2AZ0650		6"	150	1no	5 Bags
H5D2AZ0850		8"	200	1no	5 Bags

### 4A OVAL PADBOLT

	Finish	Size	Size (mm)	GATE PRO	
				BAG Qty	Outer Qty
	GALV	4"	100	1no	5 Bags
H5D4AB0450	EPOXY BLK	4"	100	1no	5 Bags
H5D4AZ0450	BZP	4"	100	1no	5 Bags

### 1A HEAVY BRENTON PADBOLT

	Finish	Size	Size (mm)	GATE PRO	
				BAG Qty	Outer Qty
	GALV	6"	150	1no	5 Bags
H5D1AG0858		8"	200	1no	5 Bags
H5D1AG1058		10"	250	1no	5 Bags

### 60MT MONKEY TAIL BOLT

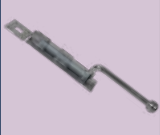
	Finish	Size	Size (mm)	GATE PRO	
				BAG Qty	Outer Qty
	GALV	12"	300	1no	5 Bags
H5D60MTG1858		18"	450	1no	5 Bags
H5D60MTB1258	EPOXY BLACK	12"	300	1no	5 Bags
H5D60MTB1858		18"	450	1no	5 Bags

### 1260 GARAGE DOOR BOLT

	Finish	Size	Size (mm)	GATE PRO	
				BAG Qty	Outer Qty
	GALV	12"	300	1no	5 Bags
H5D1260G180		18"	450	1no	5 Bags
H5D1260G240		24"	600	1no	5 Bags
H5D1260B120	EPOXY BLACK	12"	300	1no	5 Bags
H5D1260B180		18"	450	1no	5 Bags
H5D1260B240*		24"	600	1no	5 Bags

\* Not in a gusset bag

### SUFFOLK LATCH

	Finish	Type	GATE PRO	
			BAG Qty	Outer Qty
	EPOXY BLACK	20/2	1no	5 Bags
H5D20Z020	BZP	20/2	1no	5 Bags
H5D20G050	GALVANISED	20/5	1no	5 Bags
H5D20LG050		20/5 Long Thumb	1no	5 Bags
H5D20LB050	EPOXY BLACK	20/5 Long Thumb	1no	5 Bags
H5D20LZ050	BZP	20/5 Long Thumb	1no	5 Bags

### 1136 RING GATE LATCH PLAIN

	Finish	Size	Size (mm)	GATE PRO	
				BAG Qty	Outer Qty
	GALV	5"	125	1no	5 Bags
H5D1136G600		6"	150	1no	5 Bags
H5D1136B500	EPOXY BLACK	5"	125	1no	5 Bags
H5D1136B600		6"	150	1no	5 Bags
H5D1136Z500	BZP	5"	125	1no	5 Bags
H5D1136Z600		6"	150	1no	5 Bags

### 1141 RING GATE LATCH TWISTED

	Finish	Size	Size (mm)	GATE PRO	
				BAG Qty	Outer Qty
	GALV	6"	150	1no	5 Bags
H5D1141G600		6"	150	1no	5 Bags
H5D1141B600	EPOXY BLK	6"	150	1no	5 Bags

### 1819 AUTO GATE CATCH

	Finish	GATE PRO	
		BAG Qty	Outer Qty
	GALV	1no	5 Bags
H5D1819J	EPOXY BLACK	1no	5 Bags
H5D1819Z	BZP	1no	5 Bags

### 1822 STRONG AUTO GATE CATCH

	Finish	GATE PRO	
		BAG Qty	Outer Qty
	GALV	1no	5 Bags
H5D1822J	EPOXY BLACK	1no	5 Bags
H5D1822Z	BZO	1no	5 Bags



## 610 WIRE HASP & STAPLE

	Finish	Size	Size (mm)	GATEPRO	
				BAG Qty	Outer Qty
H5D610B400	EPOXY	4"	100	1no	5 Bags
H5D610B600	BLACK	6"	150	1no	5 Bags

## 617 SAFETY HASP & STAPLE

	Finish	Size	Size (mm)	GATEPRO	
				BAG Qty	Outer Qty
H5D617B450	EPOXY	4½"	113	1no	5 Bags
H5D617B600	BLACK	6"	150	1no	5 Bags
H5D617Z450	BZP	4½"	113	1no	5 Bags
H5D617Z600		6"	150	1no	5 Bags

## 149H HEAVY HASP & STAPLE

	Finish	Size	Size (mm)	GATEPRO	
				BAG Qty	Outer Qty
H5D149G080	GALV	8"	200	1no	5 Bags
H5D149G100		10"	250	1no	5 Bags
H5D149B080	EPOXY	8"	200	1no	5 Bags
H5D149B100	BLACK	10"	250	1no	5 Bags

## 1261 WIRE CABIN HOOK

	Finish	Size	Size (mm)	GATEPRO	
				BAG Qty	Outer Qty
H5D1261B040	EPOXY BLACK	4"	100	1no	5 Bags
H5D1261B060		6"	150	1no	5 Bags
H5D1261B080		8"	200	1no	5 Bags
H5D1261B120		12"	300	1no	5 Bags
H5D1261Z040	BZP	4"	100	1no	5 Bags
H5D1261Z060		6"	150	1no	5 Bags
H5D1261Z080		8"	200	1no	5 Bags
H5D1261Z120		12"	300	1no	5 Bags

## 37 CAST CABIN HOOK

	Finish	Size	Size (mm)	GATEPRO	
				BAG Qty	Outer Qty
H5D37G040	GALV	4"	100	1no	5 Bags
H5D37G060		6"	150	1no	5 Bags
H5D37G080		8"	200	1no	5 Bags
H5D37B040	EPOXY BLACK	4"	100	1no	5 Bags
H5D37B060		6"	150	1no	5 Bags
H5D37B080		8"	200	1no	5 Bags

## 500 GATE SPRING

	Finish	Size	Size (mm)	GATEPRO	
				BAG Qty	Outer Qty
H5D500B10	EPOXY	8"	200	1no	5 Bags
H5D500B12	BLACK	10"	250	1no	5 Bags
H5D500Z10	BZP	8"	200	1no	5 Bags
H5D500Z12		10"	250	1no	5 Bags

## PEDESTRIAN GATE KIT

	Kit Contains	Finish	GATEPRO	
			BAG Qty	Outer Qty
H5DGS205G	20/5L Long Thumb Heavy Suffolk Latch 2 x 18" 121 Tee Hinges 6" 2A Brenton Padbolt	GALV	1no	5 Bags
H5DGS205B		EPOXY BLK	1no	5 Bags
H5DGS205Z		BZP	1no	5 Bags
H5DGS1136G	6" 1136 Ring Gate Plain Latch 2 x 18" 121 Tee Hinges 6" 2A Brenton Padbolt	GALV	1no	5 Bags
H5DGS1136B		EPOXY BLK	1no	5 Bags
H5DGS1136Z		BZP	1no	5 Bags

## RIM LOCK & RIM KNOB

	Description	Finish	Size	GATEPRO	
				BAG Qty	Outer Qty
H5DRLB0604	Rim Lock	BLACK	6" x 4"	1no	5 Bags
H5DRK	Rim Knob		-	1no	5 Bags

## BRASS PADLOCK WITH KEYS

	Finish	Size	Size (mm)	GATEPRO	
				BAG Qty	Outer Qty
H5DPAD125	SELF COLOUR	1¼"	32	1no	5 Bags
H5DPAD15		1½"	38	1no	5 Bags
H5DPAD2		2"	50	1no	5 Bags



### TWO PIN GRAVEL BOARD SET

Image	Finish	Size	Size (mm)	GATE PRO	
				BAG Qty	Outer Qty
	GALV	6"	150	1no	5 Bags

### 324 CORNER PLATE

Image	Finish	Size	Size (mm)	GATE PRO	
				BAG Qty	Outer Qty
	BZP	3"	75	5no	5 Bags
		4"	100	5no	5 Bags

### HEAVY SELF LOCKING GATE CATCH WITH STRIKER

Image	Striker Type	Finish	GATE PRO	
			BAG Qty	Outer Qty
	Cranked	GALV	1no	5 Bags
	Straight		1no	5 Bags

### 325 MENDING PLATE

Image	Finish	Size	Size (mm)	GATE PRO	
				BAG Qty	Outer Qty
	BZP	3"	75	5no	5 Bags
		4"	100	5no	5 Bags

### KICKOVER GATE CATCH

Image	Finish	Size	Size (mm)	GATE PRO	
				BAG Qty	Outer Qty
	GALV	-	-	1no	5 Bags

### 55 CUPBOARD BUTTON

Image	Finish	Size	Size (mm)	GATE PRO	
				BAG Qty	Outer Qty
	EPOXY BLK	2"	50	10no	5 Bags
	BZP	2"	50	10no	5 Bags

### SPRING LOADED BOLT

Image	Finish	Size	GATE PRO	
			BAG Qty	Outer Qty
	BZP	1/2" Shoot	1no	5 Bags

### 1100 HOTBED HANDLE

Image	Finish	Size	Size (mm)	GATE PRO	
				BAG Qty	Outer Qty
	GALV	6"	150	1no	5 Bags
	EPOXY BLK	6"	150	1no	5 Bags

### HEAVY CHAIN ACCESSORIES

Image	Description	Finish	GATE PRO	
			BAG Qty	Outer Qty
	510 Manger Ring on Eyebolt	BZP	1no	5 Bags
	511 Hook on Plate	GALV	1no	5 Bags
	512 Staple on Plate		1no	5 Bags
	513 Ring on Plate		1no	5 Bags

### GP260 LINE PULLEY

Image	Finish	Size	Size (mm)	GATE PRO	
				BAG Qty	Outer Qty
	GALV	1 1/2"	38	1no	5 Bags

### 319 CORNER BRACE

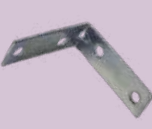
Image	Finish	Size	Size (mm)	GATE PRO	
				BAG Qty	Outer Qty
	BZP	1"	25	10no	5 Bags
		1 1/2"	38	10no	5 Bags
		2"	50	10no	5 Bags
		3"	75	5no	5 Bags
		4"	100	5no	5 Bags

### G2004 CLEAT HOOK

Image	Finish	Size	Size (mm)	GATE PRO	
				BAG Qty	Outer Qty
	BZP	5"	125	1no	5 Bags

## FOREVER WHITE & FOREVER CLEAR

### CORE USE

- For bathrooms, kitchens, utility rooms, sealing around window and door frames

### MATERIAL

- Guaranteed to stop black mould growth for 10 years
- Conforms to ISO 11600

- PERMANENTLY WATERPROOF
- SILICONE BASED
- MOULD RESISTANT
- FLEXIBLE



Code	Colour	Size	Box Qty
LSFW310	White	C3 Cartridge	12
LSFC310	Clear	C3 Cartridge	12

## 500 BATH & SANITARY SILICONE

### CORE USE

- Used in areas of high humidity such as bathrooms, toilets, showers and kitchens

### MATERIAL

- Silicone sealant that contains a high level of powerful anti-fungal compound to protect the sealant
- Tested to ISO 8339 and ISO10590/10563

- PREMIUM QUALITY
- MID MODULUS
- ACETOXY CURE
- SILICONE BASED
- MOULD RESISTANT



Code	Colour	Size	Box Qty
LSBI310	Ivory	C3 Cartridge	25
LSBC310	Translucent	C3 Cartridge	25
LSBW310	White	C3 Cartridge	25

## 200 CONTRACTORS LMA SILICONE

### CORE USE

- Sealant for general glazing, weather proofing, sanitary applications

### MATERIAL

- Conforms to BS5889 (except clause 9)

- QUICK CURING
- GAP FILLING
- MOULD RESISTANT
- SILICONE BASED
- ACETOXY CURE



Code	Colour	Size	Box Qty
LC2000B	Brown	C3 Cartridge	25
LC2000C	Translucent	C3 Cartridge	25
LC2000W	White	C3 Cartridge	25

## 450 BUILDERS SILICONE

### CORE USE

- Used in construction of all types of door and window frames
- Sticks to virtually all surfaces

### MATERIAL

- Conforms to BS5889 (A) and ISO 11600

- PREMIUM QUALITY
- LOW MODULUS
- SILICONE BASED
- NON-CORROSIVE



Code	Colour	Size	Box Qty
LBSC310	Clear	C3 Cartridge	25
LBSW310	White	C3 Cartridge	25

## 125 ONE HOUR CAULK

### CORE USE

- Ideal for sealing and filling cracks and gaps prior to decorating
- Used around skirting boards, ceiling cornices, window and door frames and stair treads

### MATERIAL

- Conforms to EN15651

- PERMANENTLY FLEXIBLE
- NO SANDING DOWN REQUIRED
- CAN BE OVERPAINTED OR COVERED WITH WALLPAPER
- FAST DRYING



Code	Colour	Size	Box Qty
LOHC310	White	C3 Cartridge	25
LOHC350	White	C4 Cartridge	12

## 225 INDUSTRIAL & GLAZING SILICONE

### CORE USE

- Typically used for single glazing, draught-proofing and general industrial use
- Adheres to most smooth and non-porous substrates

### MATERIAL

- Temperature resistant to 200°C

- ACETOXY CURE
- SILICONE BASED
- PERMANENTLY FLEXIBLE
- WATERPROOF SEAL



Code	Colour	Size	Box Qty
LSIC310	Clear	C3 Cartridge	25
LSIW310	White	C3 Cartridge	25



TRANSLUCENT



WHITE



IVORY



GREY



BROWN

### FIRE MATE SEALANT

#### CORE USE

- To prevent the passage of fire and smoke: fire rating of up to 5 hours in certain joint configurations

#### MATERIAL

- Intumescent sealant that swells when exposed to temperatures in excess of 125°C

- ACRYLIC BASED
- PERMANENTLY FLEXIBLE
- FAST CURING(15 MINS)
- FIRE RATED TO BS476 PART 20/22



Code	Colour	Size	Box Qty
LISW310	White	C3 Cartridge	25

### LEAD MATE SEALANT

#### CORE USE

- Provides a fully waterproof joint that will not crack or shrink
- Formulated as an alternative to mortaring lead flashing and sheet into brick, stone and concrete

#### MATERIAL

- Gives exceptional adhesion to soft metals such as lead and brass
- Certified to European standard EN15651

- LOW MODULUS
- NEUTRAL CURE
- HIGH FLEXIBILITY



Code	Colour	Size	Box Qty
LLS310	Lead Grey	C3 Cartridge	25

### WEATHER MATE SEALANT

#### CORE USE

- Can be used for industrial metal panel bonding and gap filling
- Used in conjunction with bitumen, asphalt, lead and galvanised steel

#### MATERIAL

- Can be applied to wet surfaces (even underwater)

- PERMANENTLY FLEXIBLE
- INDOOR & OUTDOOR USE
- ISOCRYLIC FORMULA



Code	Colour	Size	Box Qty
LWSC310	Clear	C3 Cartridge	25

### ACRYLIC BASED SEALANTS

- MAINLY OBTAINED FROM WATER-BASED ACRYLIC RESINS, THEREFORE THEY ARE NOT SUITABLE FOR USE IN LOCATIONS SUBJECT TO DIRECT WATER EXPOSURE
  - OVERPAINTABLE ONCE CURED
  - ENVIRONMENTALLY FRIENDLY

**MOSTLY USED**  
ASSEMBLY OF WOOD, PVC, IRON, JOINERY  
INTERIOR & EXTERIOR DECORATION  
COVERING CRACKS & GAPS  
CONSTRUCTION, PLASTERING

### SILICONE BASED SEALANTS

- MADE UP WITH A CHEMICAL SOLVENT
- RESISTANT TO MOISTURE, CHEMICALS & ALL WEATHER CONDITIONS
- PERMANENTLY FLEXIBLE ONCE CURED & MAINTAINS THIS FLEXIBILITY EVEN AT EXTREME TEMPERATURES

**MOSTLY USED**  
PVC, ALUMINIUM, WOOD JOINERY  
BATHTUBS, SINKS,  
TILES, CERAMICS WATER & DUST  
INSULATION OF VEHICLES





## BATH & KITCHEN SEALANT

### CORE USE

- High quality sealant suitable for general use in the bathroom and kitchen
- Effective and economical

- MOULD PREVENTION
- CAN BE OVERPAINTED



Code	Colour	Size	Box Qty
LABW310	White	C3 Cartridge	12

## ROOF & GUTTER SEALANT

### CORE USE

- Provides instant weather-proofing to a wide variety of roofing applications
- Adheres to most common roofing materials including bitumen, asphalt, felt, metals and wood

- PERMANENT WEATHER-PROOFING
- QUICK DRYING



Code	Colour	Size	Box Qty
LRGB310	Black	C3 Cartridge	12

## EXTERNAL FRAME SEALANT

### CORE USE

- High quality sealant that provides a long lasting, permanently flexible seal
- Do not apply it at temperatures below 4°C

- ACRYLIC BASED
- INDOOR & OUTDOOR USE
- MOULD RESISTANT
- CAN BE OVERPAINTED



Code	Colour	Size	Box Qty
LODB310	Brown	C3 Cartridge	12
LODW310	White	C3 Cartridge	12
LODS310	Stone	C3 Cartridge	12
LODG310	Grey	C3 Cartridge	12

## GENERAL PURPOSE SILICONE

### CORE USE

- Adheres to most smooth and non-porous materials

### MATERIAL

- High strength waterproof seal
- Conforms to BS5889 (B)

- SILICONE BASED
- MOULD PREVENTION
- PERMANENTLY FLEXIBLE



Code	Colour	Size	Box Qty
LSMB310	Brown	C3 Cartridge	12
LSMC310	Clear	C3 Cartridge	12
LSMK310	Black	C3 Cartridge	12
LSMW310	White	C3 Cartridge	12

## DECORATORS FLEXIBLE FILLER

### CORE USE

- Filler and sealant that remains permanently flexible
- Can be covered with wallpaper
- No sanding down is required

- ACRYLIC BASED
- CAN BE OVERPAINTED
- FAST DRYING
- FLEXIBLE



Code	Colour	Size	Box Qty
LFDW310	White	C3 Cartridge	12

## SEALANT GUNS

- Sturdy skeleton gun with hexagonal rod, reinforced ring and hook end



Code	Size	Box Qty
LGGU	Suits C3/C4 Cartridges	1

# CLEANERS & LUBRICANTS

## SILICONE SPRAY

### CORE USE

- Highly effective lubricant for a wide array of automotive, industrial and household applications
- Ideal for lubricating surfaces that may be damaged by conventional lubricants such as grease or oil, and it also helps prevent the cracking and drying of rubber
- Easy installation of EPDM gaskets to window and door frames



Code	Size (ml)	Box Qty
LSS400	400	12

## WONDER WIPES

### CORE USE

- Specifically formulated to clean hands, tools and surfaces from wet and semi-cured paint, sealant, adhesive, bitumen, expanding foam, oil, grease and even silicone

### MATERIAL

- Contains anti-bacterial additive to BSEN 1276



**THE FIRST CHOICE WIPE OF THE NATIONS  
BUILDERS AND TRADESMEN**

Code	Type	Size	Box Qty
LWW100	Multi-Use	100 Wipes per Tub	6
LWW300	Multi-Use	300 Wipes per Tub	1
LWWHD075	Heavy Duty	75 Wipes per Tub	6

### GUN GRADE EXPANDING FOAM

#### CORE USE

- Fills irregular gaps, fixes framework, insulates and sound deadens

#### MATERIAL

- Expands on application
- Can be cut, sawn, plastered and sealed over after approx. 1 hour

- POLYURETANE BASED
- QUICK SETTING
- GAP FILLING
- INSULATING
- SOUND DEADENING



Code	Size (ml)	Box Qty
LFGG750	750	12

### FIRE FOAM B1 & B2

#### MATERIAL

- Comes in a hand-held canister
- Expands on application to up to 50 times the can content and meets the requirements of the test criteria for BS 476 Part 20
- Once cured, the foam can be cut, sawn, plastered and sealed over after approx. 1 hour

- POLYURETANE BASED
- FIRE RETARDANT
- GAP FILLING



Code	Type	Size (ml)	Fire Rating	Box Qty
LFFB1H750	B1	750	up to 4 hours	12
LFFB2750	B2	750	up to 2 hours	12

### NO WASTE FOAM

#### CORE USE

- Filling (gaps in stone, brick, concrete, around pipes, window/door frames, etc.)
- Fixing (window/door frames, timber structures)
- Insulating (behind cladding to exterior walls, behind soffit and barge boards)

#### MATERIAL

- 24 months shelf life (compared to 12 months for conventional foams)
- Hand-held foam that allows part used cans to be saved and used again
- Its unique safety valve will not clog or leak



Code	Size (ml)	Box Qty
LFNW750	750	12

### DUAL PURPOSE FOAM CLEANER

#### CORE USE

- To remove wet/uncured foam
- Includes a spray nozzle for use without the gun applicator

#### MATERIAL

- Aerosol product containing a solvent



Code	Size (ml)	Box Qty
LFFC500	500	12

### FIX & FILL EXPANDING FOAM

#### CORE USE

- For broad gaps where most conventional fillers would fail

#### MATERIAL

- Foam that expands greatly on application up to 150 times of original can contents
- Can be cut, sawn, plastered and sealed over after approx. 1 hour

- POLYURETANE BASED
- QUICK SETTING
- GAP FILLING
- INSULATING
- SOUND DEADENING



Code	Size (ml)	Box Qty
LFOA500	500	12
LFOA750	750	12

### PINKGRIP DRYFIX DRYWALL ADHESIVE

#### CORE USE

- For rapid installation of plasterboard, insulation boards and other sheet materials such as roof decking and floorboards
- It bonds to most common building substrates

#### MATERIAL

- The foam expands very minimally on application but enough to fill any gaps on uneven surfaces
- Conforms to EN 13501-1 Class E for fire rating

- FAST CURING
- FIRE RETARDANT
- ONE CAN FIX 5 STANDARD BOARDS



Now has a **dual flow value**: can be applied either by the nozzle provided or by the Pinkgrip Dry Fix applicator gun

Code	Description	Colour	Size	Box Qty
LPDF750	Pinkgrip Dry Fix FR	Pink	750ml	12
LPDFG	Pinkgrip Dry Fix Applicator Gun		Suits 750ml	1

### P45 FOAM APPLICATOR GUN

- Applicator gun for use with foam products



Code	Description	Box Qty
LFG	P45 Medium	1

## EB25 POLYMER ADHESIVE & SEALANT

### CORE USE

- Can be used on any material, in most weather conditions, even underwater
- Certified for use in sanitary and food preparation areas

### MATERIAL

- Uses a unique polymer blend and cutting-edge technology

- INDOOR & OUTDOOR USE
- HIGH STRENGTH
- RESISTANT TO MOULD, EXTREME TEMPERATURES & CHEMICALS
- FLEXIBLE



Code	Colour	Size (ml)	Box Qty
LEB25C300	Clear	300	12
LEB25W300	White	300	12

## INSTANT NAILS

### CORE USE

- Provides a quick grab and replaces mechanical fixings in many applications

- PAINTABLE WHEN CURED
- DRIES WHITE
- SOLVENT FREE
- HIGH STRENGTH
- GAP FILLING



Code	Colour	Size	Box Qty
LIN310	Dries White	C3 Cartridge	12
LIN250	Dries White	C2 Easi-Squeeze	12

## PINKGRIP

### CORE USE

#### Solvent free version:

- For indoor use
- Bonds wood, brick, plasterboard, styrofoam, polystyrene, plastics and metals - at least one surface should be porous

#### Standard version:

- For indoor and outdoor use
- Adheres to almost any building substrate

### MATERIAL

- Direct bond, gap-filling adhesive with a revolutionary initial grip



Code	Description	Colour	Size (ml)	Box Qty
LGPNS350	Pinkgrip	Pink	350	12
LGPNS350	Pinkgrip Solvent Free	Pink	350	12

## STICKS LIKE SH\*T

### CORE USE

- For indoor and outdoor use
- Bonds to most surfaces: wood, concrete, brick, plaster, glass, ceramics, metals, rigid PVC, insulation boards and foam polystyrene

- WATERPROOF
- MOULD RESISTANT
- PAINTABLE WHEN CURED



Code	Colour	Size (ml)	Box Qty
LSLSC290	Clear	290	12
LSLSW290	White	290	12

## GUN A NAIL

### CORE USE

- Multi-purpose building adhesive for use in a wide variety of building and home improvement applications
- Can be used where at least one of the substrates to be bonded is porous

- HIGH STRENGTH
- SOLVENT FREE
- GAP FILLING



Code	Colour	Size	Box Qty
LGUS380	Beige	C3 Cartridge	25

## MULTI STICK

### CORE USE

- Ideal for bonding mirrors to common substrates, jointing cladding panels and for applications where resistance to chemical spillage is required
- Can bond difficult materials such as specialised polymer systems, metal and fibreglass

- INDOOR & OUTDOOR USE
- HIGH QUALITY & STRENGTH
- INCREDIBLE INITIAL GRIP



Code	Colour	Size (ml)	Box Qty
LSMXW350	White	350	12

## MIRROR MATE

### CORE USE

- Specially formulated for bonding mirrors to most common surfaces

### MATERIAL

- Based on MS Polymer technology
- The totally neutral curing system will not attack the mirror backing

- SOLVENT FREE
- ONE COMPONENT



Code	Colour	Size	Box Qty
LMMW310	White	C3 Cartridge	12

## STIXALL

### CORE USE

- Ability to both bond and seal virtually everything to anything

- QUICK CURING
- WATER RESISTANT
- OVERPAINTABLE

### MATERIAL

- Can be applied to wet surfaces, even under water
- Based on hybrid polymer technology



Code	Colour	Size (ml)	Box Qty
LSXC290	Clear	290	12
LSXG290	Grey	290	12
LSXK290	Black	290	12
LSXW290	White	290	12



## WOOD & TILE ADHESIVES

### 502 ALL PURPOSE WOOD ADHESIVE

#### CORE USE

- For all general woodworking and joinery

#### MATERIAL

- Provides a high strength bond that is stronger than the wood itself
- Conforms to EN 204 (D3) and BS 14256

- INDOOR & OUTDOOR USE
- HIGH QUALITY & STRENGTH
- QUICK CURING
- RESIN BASED



Code	Colour	Size (litre)	Box Qty
LAPW0125	Dries Clear	0.125	12
LAPW025	Dries Clear	0.25	12
LAPW050	Dries Clear	0.5	20
LAPW100	Dries Clear	1	12
LAPW500	Dries Clear	5 litres	4

### D4 WOOD ADHESIVE

#### CORE USE

- Can be used internally or externally

#### MATERIAL

- Provides impact and temperature resistant bond that is usually stronger than the wood itself
- Meets the requirements of EN204 and WATT91

- INDOOR & OUTDOOR USE
- SOLVENT FREE
- HIGH STRENGTH
- WATERPROOF
- INDUSTRIAL GRADE D4
- QUICK CURING



BASED ON THE LATEST HYBRID RESIN TECHNOLOGY

Code	Colour	Size (litre)	Box Qty
LPGWA100	Dries Clear	1	12

### POLYURETHANE WOOD ADHESIVE

#### GEL FORM:

Thixotropic, gap filling gel adhesive that is particularly suitable for equipment manufacture and production line applications where rapid handling is required

#### LIQUID FORM:

Ideal for horizontal applications where greater economy is required

At least one surface should be porous

- QUICK SETTING
- CONFORMS TO EN204
- D4 STRENGTH



Code	Colour	Size	Set Time (mins)	Type	Box Qty
LWA05M310	Translucent	310ml	5	Gel	12
LWA30M310	Translucent	310ml	30	Gel	12
LWA05M750	Brown	750g	5	Liquid	6
LWA30M750	Brown	750g	30	Liquid	6

### 701 NON SLIP TILE ADHESIVE

#### CORE USE

- Designed for general use in bathroom and kitchen areas

#### MATERIAL

- Conforms to BS 5980 as a type 2, class B adhesive and EN 12004 type DIT

- READY MIXED
- EXTRA SLIP RESISTANCE
- ACRYLIC BASED



Code	Colour	Size (litre)	Box Qty
LTA0250	Off White	2.5	4
LTA1000	Off White	10	1

### 708 SELF LEVEL FLOOR COMPOUND

#### CORE USE

- Used to level out uneven floors and screeds prior to laying ceramic tiles, thermoplastic tiles, wood block flooring or carpet

#### MATERIAL

- Cement based product
- Free flowing mix that sets in 90 minutes and can be overlaid in 8 hours at normal temperatures



Code	Colour	Size (kg)	Box Qty
LSLC200	Grey	20	1

### 730 POWDER WALL TILE GROUT

#### CORE USE

- Simply mix with water to give a pure white paste
- Suitable for kitchens, shower areas and bathrooms

#### MATERIAL

- Grouting compound with added PVA to promote adhesion

- INDOOR & OUTDOOR USE
- CEMENT BASED
- POWDER FORM
- GREAT ADHESION
- CONTAINS MOULD SHIELD



Code	Colour	Size (kg)	Box Qty
LWTG025	White	2.5	1





## CONTACT ADHESIVES

## TECHNICAL MORTARS

### STICK 2 SPRAY CONTACT ADHESIVE

#### CORE USE

- Glue that bonds to most common materials: wood, concrete, stone, tiles, rubber, foam, metals, rigid plastics, polyethylene, canvas fabrics, cardboard, paper and cork
- Ideal for securing most carpets and floor coverings

- INDOOR & OUTDOOR USE
- SPRAYABLE



Code	Colour	Size (ml)	Box Qty
LSCA500	Beige	500	12

### JETCEM RAPID REPAIR CEMENT

#### CORE USE

- Ideal for rapid patching or when a fast repair job is needed

- CEMENT BASED
- QUICK SETTING (30 MINS)
- TESTED TO BS EN1504 - 3 CLASS R4

#### MATERIAL

- Sets even in cold and wet conditions



Code	Description	Colour	Size (kg)	Box Qty
LJCRS030	Rapid Set Cement	Grey	3	4
LJCRS060	Rapid Set Cement	Grey	6	2

### ALL PURPOSE CONTACT ADHESIVE

#### CORE USE

- For both professional and DIY use
- Used for bonding a variety of materials such as PVC, leather and all types of wood

- INDOOR & OUTDOOR USE
- RUBBER BASED



Code	Brand	Size	Box Qty
LCA0250	Stick 2	250ml	12
LCA0750	Stick 2	750ml	12
LCA5000	Stick 2	5 litres	4

### JETCEM PREMIX SAND AND CEMENT

#### CORE USE

- Ideal for rapid patching or when a fast repair job is needed

- SAND & CEMENT BASED
- QUICK SETTING (30 MINS)

#### MATERIAL

- Sets even in cold and wet conditions



Code	Description	Colour	Size (kg)	Box Qty
LJCPM020	Premix Sand & Cement	Grey	2	6
LJCPM060	Premix Sand & Cement	Grey	6	2

### MITRE FAST BONDING KIT

#### CORE USE

- A two part instant adhesive system which dramatically reduces assembly times for mitre joints compared to conventional wood adhesives

- CONTAINS**
- 1 x CYANOACRYLATE ADHESIVE
  - 1 x AEROSOL ACTIVATOR



Code	Colour	Size	Box Qty
LMBK200	Clear	50g adhesive + 200ml activator	6

### STICK 2 ALL PURPOSE CARDED SUPERGLUE

#### CORE USE

- Bonds non-porous surfaces such as plastic, metal, PVCu, rubber, ceramics and more

- 1 MIN INSTANT BOND
- FILLS GAPS UP TO 0.1MM



Code	Colour	Size	Box Qty
LSAPSG3	Clear	3gm	12

## OTHER ESSENTIALS

### WINTER PRODUCTS

#### SCREEN DE-ICING SPRAY

- Works quickly to melt ice and to -15°C

#### CONCENTRATED SCREEN WASH

- Removes traffic film, dirt and insect residue
- Helps prevent freezing
- In summer conditions use 1 part concentrate to 9 parts water, in winter conditions use 1 part concentrate to 1 part water and in severe conditions use undiluted



Code	Description	Size	Box Qty
LXSDE005	Screen De-icing Spray	500ml	12
LXSWC050	Screen Wash Concentrate	5 litres	3

### SURVEYLINE MARKER SPRAY

#### CORE USE

- Designed for temporary or semi-permanent site marking
- Use on soil, concrete, grass, gravel, asphalt and tarmac

- AEROSOL
- READY TO USE



Code	Colour	Size (ml)	Box Qty
LMSY750	Yellow	700	12
LMSR750	Red	700	12
LMSW750	White	700	12

### CREOSOTE

#### CORE USE

- Preservative for wooden sheds and fences

#### MATERIAL

- Conforms to EC Directive for the use of Coal Tar Creosote

- PROFESSIONAL USE ONLY
- OUTDOOR USE
- OIL BASED
- 100% COAL TAR



Code	Colour	Size (litre)	Box Qty
LCRSOBL200	Dark Brown	20	1

### CREOCOTE

#### CORE USE

- Ideal for sheds, fences and posts
- Protects and colours external timbers: soaks in deep to penetrate smooth and sawn timbers

- TIMBER TREATMENT
- PRESERVATIVE
- GAS OIL BASED
- COVERAGE: 3-5M<sup>2</sup>/LITRE



Code	Colour	Size (litre)	Box Qty
LCRCOBL040	Black	4	4
LCRCOBL200	Black	20	1
LCRCODA040	Dark	4	4
LCRCODA200	Dark	20	1
LCRCOLI040	Light	4	4
LCRCOLI200	Light	20	1

### TRIPLE ACTION WOOD TREATMENT

#### CORE USE

- Specially designed to deeply penetrate all wood and joinery to give lasting protection
- Protects from damage caused by rot, fungi or insects
- Takes care of remedial wood treatment and preservation in one can



Code	Colour	Size (litre)	Box Qty
LWTTA010	Clear	1	10
LWTTA050	Clear	5	4



CLEAR

LIGHT

DARK

BLACK

### BENEFITS OF USING WOOD TREATMENTS & PRESERVATIVES

- PROLONGS THE LIFE OF THE WOOD
- PREVENTS CONDITIONS THAT CAN CAUSE DEGRADATION AND DISINTEGRATION OF WOOD OVER TIME
- PROTECTS WOOD FROM THE MOST COMMON CAUSES OF WOOD ROT SUCH AS MOULD, ALGAE, FUNGI AND INSECTS
- MAKES WOOD WATER REPELLENT
- PROTECTS AGAINST FREEZE/THAW CYCLES

## 201 MORTAR ADMIX

### CORE USE

- Replaces lime in the mix
- Prevents shrinkage, cracking and crazing during the setting process
- Provides resistance to freeze/thaw cycles

- LIQUID PLASTICISER
- REPLACES LIME IN THE MIX



Code	Size (litre)	Box Qty
LMA5	5	4
LMA25	25	1

## OPTI-MIX INTEGRAL WATERPROOFER

### CORE USE

- Plasticiser, waterproofing agent and salt inhibitor
- Improves water resistance and workability of mortars

- CONTROLLED DOSAGE
- CONSISTENT MIX

1 LITRE = 25 LITRES OF STANDARD SOLUTION

Recommended dosage: 20-40ml per 50kg of cement



Code	Size (litre)	Box Qty
LOP01	1	12

## 202 INTEGRAL WATERPROOFER

### CORE USE

- Provides long term water protection to mortar, concrete and rendering
- Mostly used for pool linings, roofing, external rendering and pointing, even structures below ground level

- LIQUID ADDITIVE



Code	Size (litre)	Box Qty
LIW050	5	4

## OPTI-MIX MORTAR PLASTICISER

### CORE USE

- Improves the workability of mortar, prevents cracking, shrinkage
- Provides resistance to freeze/thaw cycles

- CONTROLLED DOSAGE
- SUPERIOR STRENGTH
- EASY TO USE

### MATERIAL

- Highly concentrated air entraining liquid plasticising admixture which is 25 times the strength of standard solutions



Code	Size (litre)	Box Qty
LOM01	1	12

## 203 ACCELERATOR & FROSTPROOFER

### CORE USE

- Formulated to accelerate setting and hardening times of mortar, concrete, screeds and rendering
- Effective in sub zero temperatures and at normal temperatures where a rapid set is required

- LIQUID FORM
- QUICK SETTING & HARDENING
- PROVIDES FROST PROTECTION WHILE SETTING



Code	Size (litre)	Box Qty
LAFP050	5	4

## 501 PVA BOND

### CORE USE

- Ideal for priming unsound surfaces prior to plastering or painting as an adhesive on wood, cork and for general dust sealing
- Adheres to most common building and DIY materials

- CEMENT & PLASTER ADMIXTURE
- PRIMER & SEALER
- BONDING AGENT



Code	Size (litre)	Box Qty
LPVA050	0.5	20
LPVA100	1	12
LPVA250	2.5	6
LPVA500	5	4

## 204 EVERMIX 3 in 1

### CORE USE

- Particularly for use in renders, dry dash and pebble-dashing, however it can also be used in any cement mixture where waterproofing and increased workability are required

- WATERPROOFS
- PLASTICISES
- RETARDS

### MATERIAL

- Assists workability, reduce water penetration and allow larger areas to be covered in one application



Code	Size (litre)	Box Qty
LEVER05	5	4

## 503 S.B.R. BOND

### CORE USE

- Bonding agent and admixture for use in areas subject to humidity, dampness and continuous water contact

- LATEX BASED
- WATER RESISTANT

### MATERIAL

- Improves water resistance of cement mixtures



Code	Size (litre)	Box Qty
LSBR050	5	4



### 506 CONTRACTORS PVA BOND

#### CORE USE

- Ideal for priming and dust sealing on flaking surfaces and as an adhesive on cork, and wood

#### MATERIAL

- Adheres to most common building and DIY materials

- CEMENT & PLASTER ADMIXTURE
- PRIMER & SEALER



Code	Size (litre)	Box Qty
LCONPVA500	5	4

### 401 BRICK & PATIO CLEANER

#### CORE USE

- Dissolves mortar and cement stains, ingrained dirt and paint
- Can be used on most mineral surfaces such as brick, stone, concrete and paving flags
- Clean up after use with cold water

- FAST ACTING
- LIQUID BASED - 9.5% STRENGTH



Code	Size (litre)	Box Qty
LBPC050	5	4

### 507 RENDAGRIP

#### CORE USE

- Render bonding agent that is used for concrete, lightweight block and brick

#### MATERIAL

- Contains a fine aggregate to provide an improved key before applying render on external surfaces
- One coat application only

- EXTRA GRIP



Code	Colour	Size (litre)	Box Qty
LRG010	Red	10	4

### 402 WATERSEAL

#### CORE USE

- For use on all mineral substrates such as brick, block, concrete, pebble-dash and rendering

#### MATERIAL

- Non-flammable and solvent free formula

- HIGH PERFORMANCE
- TRANSPARENT
- WATER REPELLENT
- PREVENTS WATER PENETRATION



Code	Colour	Size (litre)	Box Qty
LWTS050	Clear	5	4

### FEBOND BLUE GRIT

#### CORE USE

- Plasterers grip coat bonding agent that provides an improved key to textured surfaces and ceramic tiles

- HIGH PERFORMANCE
- READY TO USE



Code	Colour	Size (litre)	Box Qty
LFBBG010	Blue	10	1

### 405 PATH & PATIO SEAL

#### CORE USE

- Used to seal patios, paths, natural stone, concrete and block paving
- Protects from the effects of sunlight, water, oil, petrol and moss growth

- SOLVENT FREE
- ACRYLIC BASED
- DRIES CLEAR
- HARD-WEARING
- WATER REPELLENT
- SLIP RESISTANT



Code	Colour	Size (litre)	Box Qty
LPPS005	Clear	5	4
LPPS025	Clear	25 Litres	1

### 208 POWDER MORTAR TONE

#### CORE USE

- Used for permanently colouring all types of mortars, rendering, concrete and pointing

#### MATERIAL

- The pigments disperse easily into the mix to give a uniform shade for the mix batch

- PREMIUM QUALITY
- WIDE VARIETY OF COLOUR DEPTHS



Code	Colour	Size (kg)	Box Qty
LMT01OBL	Black	1	6
LMT01OBU	Buff	1	6
LMT01ORE	Red	1	6



## ROLL & STROLL FLOOR PROTECTOR

### Premium carpet protector

- Protects against paint spillage with a heavy duty anti-slip cross weave which will not tear

### Hard floor protector

- Works on all hard surfaces such as timber, laminate, ceramic floors, work-tops

- WATER & FLAMEPROOF
- EASY TO UNWIND
- ADHESIVE COATING
- PROTECTS AGAINST PAINT SPILLAGE



Code	Description	Colour	Size	Box Qty
LRST020	Carpet Protector	Yellow	600mm x 25m	6
LRSTH025	Hard Floor Protector	Clear	600mm x 25m	6

## WHITE SPIRIT

### CORE USE

- Solvent designed for thinning paints and varnishes, cleaning brushes and general household degreasing and cleaning

- CONFORMS TO BS 245



Code	Colour	Size (litre)	Box Qty
LWS0750	Clear	0.75	12
LWS0200	Clear	2	8

## MULTI PURPOSE WOOD FILLER

### CORE USE

- Fills nail holes, cracks, gaps and minor imperfections in wood
- Can be stained, varnished and painted

- WOOD FILLER
- PREMIUM QUALITY
- SOLVENT FREE
- EASY TO SAND



Code	Type	Size (ml)	Box Qty
LWFMPDIG250	Light Stainable	250	6
LWFMPMED250	Medium Stainable	250	6
LWFMPWHI250	White	250	6

## BOILED LINSEED OIL

### CORE USE

- Used to replace the natural sheen in aged/tired wood
- Can be mixed with mastic sand to make trowel grade pointing mastic

- INDOOR & OUTDOOR USE
- WOOD TREATMENT
- QUICK DRYING



Code	Size (ml)	Box Qty
LLSOB00500	500	12

## ONE STRIKE FILLER

### CORE USE

- Used for repairs to plaster, brick, wood, etc.
- Can be screwed or nailed into when dry

- INDOOR & OUTDOOR USE
- POWDER FORM
- NON-SHRINK
- ADDED PVA FOR EXTRA STRENGTH
- QUICK DRYING (30 MINS)



Code	Colour	Size (litre)	Box Qty
LSOF0500	White	0.45	12
LSOF1000	White	1	6

## TWO PART WOOD FILLER

### MATERIAL

- Once mixed, the filler sets hard to a shatterproof finish and may be drilled, carved or planed once dry



- INDOOR & OUTDOOR USE
- QUICK DRYING (30 MINS)
- EASY TO MIX & APPLY
- WEATHERPROOF

Code	Colour	Size (kg)	Box Qty
LWF2PLIG0500	Light Stainable	0.5	6
LWF2PLIG1400	Light Stainable	1.4	6
LWF2PMED0500	Medium Stainable	0.5	6
LWF2PMED1400	Medium Stainable	1.4	6
LWF2PWHI0500	White	0.5	6
LWF2PWHI1400	White	1.4	6

## DUST SHEETS

### CORE USE

- Protects from spills, splashes and dust
- Resists wear from tools, stepladders and feet

- REVERSIBLE
- MACHINE WASHABLE



- POLYTHENE INTERLAMINATE
- STOPS LIQUID PASSING THROUGH

Code	Description	Colour	Size	Box Qty
LCDS1209	Standard Cotton	Natural	12 x 9ft	10
LCDSL1209	Laminated Cotton	Natural	12 x 9ft	10

## TURPENTINE SUBSTITUTE

### CORE USE

- A solvent designed for cleaning paint off brushes and rollers to prolong their life and as a general household cleaner/degreasant



Code	Colour	Size (ml)	Box Qty
LTS00750	Clear	750	12

WE ALSO SELL TARPULINS & HESSIAN SHEETING  
IN OUR BUILDING PRODUCTS SECTION



## MAMMOTH MEGA TAPE

### MAMMOTH MEGA TAPE

- All purpose duct tape of top quality cloth with aggressive natural rubber adhesive which is tough, durable and waterproof

### MAMMOTH ALUMINIUM TAPE

- Heat and light reflective foil tape (heat resistant to 180°C, flame retardant to Class O)
- Ideal for use as a vapour barrier between foil faced insulation panels in roof and wall applications, duct sealing on air conditioning and ventilation



Code	Description	Colour	Size	Pack Qty
LSTB	Mammoth Mega Tape	Black	50mm x 50m	1
LSTS	Mammoth Mega Tape	Silver	50mm x 50m	1
LTAF05045	Aluminium Foil Tape	Silver	50mm x 45m	24
LTAF07545	Aluminium Foil Tape	Silver	75mm x 45m	16
LTAF10045	Aluminium Foil Tape	Silver	100mm x 45m	12

## MASKING TAPE

### CORE USE

- General purpose, trade quality, off white masking tape
- Low tack for delicate surfaces



- GREAT ADHESION
- COMPATIBLE WITH SOLVENT & WATER BASED PAINTS

Code	Type	Colour	Size	Pack Qty
LTMW050019	General Purpose	Off-White	19mm x 50m	12
LTMW050025	General Purpose	Off-White	25mm x 50m	9
LTMW050038	General Purpose	Off-White	38mm x 50m	6
LTMW050050	General Purpose	Off-White	50mm x 50m	6
LTMW050075	General Purpose	Off-White	75mm x 50m	4
LTMLTW050025	Low Tack	Off-White	25mm x 50m	9
LTMLTW050050	Low Tack	Off-White	50mm x 50m	6

## S.O.S. SELF AMALGAMATING TAPE

### CORE USE

- Ideal for stopping leaks in water pipes and other pipework carrying liquid
- For temperatures between -40°C and 100°C
- For marine, auto, household and professional work

### MATERIAL

- Stretches and binds with itself to form a waterproof bandage

- WATERPROOF
- GIVES A PERMANENT REPAIR IN 1 HOUR



Code	Colour	Size	Box Qty
LTSOSB005025	Black	25mm x 5m	12

## SELF ADHESIVE BARRIER TAPE

### CORE USE

- Self-adhesive PVC tape that is suitable for floors, walls and overhead
- Also used for hazard marking

- INDOOR & OUTDOOR USE
- ABRASION RESISTANCE
- DAMP TOLERANT
- HIGHLY VISIBLE
- DURABLE



Code	Colour	Size	Pack Qty
LTBARW03050	Red/White	50mm x 33m	1
LTBABY033050	Black/Yellow	50mm x 33m	1

## NON-ADHESIVE BARRIER TAPE

### CORE USE

- Polythene barrier tape that is ideal for marking out no-go or hazardous areas

- SUPER STRENGTH
- NON-ADHESIVE
- SUPPLIED IN A TAPE DISPENSING BOX



CAN BE USED IN CONJUNCTION WITH FENCING PINS, SEE OUR FENCING SECTION

Code	Colour	Size	Box Qty
LTBRW070500	Red/White	70mm x 500m	1

## JOINTING TAPE

### CORE USE

- Used for jointing membranes and trays in construction/roofing applications
- Ensures a permanent and watertight joint on most membranes



- NON-DRYING
- NON-HARDENING
- WATERPROOF

Code	Type	Material	Size	Pack Qty
LTJDS05010	Double Sided	Butyl	50mm x 10m	1
LTJSS07533	Single Sided	PVC	75mm x 33m	1

## WARNING TAPE

### CORE USE

- LDPE film which is printed with a cautionary message to warn of the presence of buried utilities

- THICKNESS: 40µm
- HIGH STRENGTH
- NON-ADHESIVE
- HIGHLY VISIBLE
- DURABLE



Code	Colour	Warning	Size	Pack Qty
LTUWELE150365	Yellow	Electric Cable	150mm x 365m	1
LTUWGAS150365	Yellow	Gas Pipe	150mm x 365m	1
LTUWSEW150365	Red	Foul Sewer	150mm x 365m	1
LTUWWAT150365	Blue	Water Pipe	150mm x 365m	1



YOU CAN FIND MORE INFORMATION ON

[www.johngeorge.co.uk](http://www.johngeorge.co.uk)  
[www.henryshaw.co.uk](http://www.henryshaw.co.uk)



## FLASHING TAPE

### CORE USE

- Instant seal for new roofs or repairing roofs & guttering

- SELF-ADHESIVE
- NATURAL LEAD LOOK
- WATERTIGHT
- LONG LIFE



### MATERIAL

- Bitumen based self-adhesive aluminium with a lead appearance

Code	Size	Pack Qty
LBFT075	75mm x 10m	1
LBFT100	100mm x 10m	1
LBFT150	150mm x 10m	1
LBFT225	225mm x 10m	1
LBFT300	300mm x 10m	1

## EVERCRYL

### CORE USE

- Roof repair compound
- Effective on all common roofing surfaces
- Application with a brush

- RESIN BASED
- FIBRE REINFORCED
- INSTANT ROOF REPAIRS



### MATERIAL

- Can be applied in frosty conditions down to -5°C and is instantly waterproof when applied

Code	Colour	Size (kg)	Pack Qty
LECC025	Grey	2.5	1
LECB025	Black	2.5	1
LECC050	Grey	5	1
LECB050	Black	5	1



## LEAD MATE PATINATION OIL

### CORE USE

- Provides a protective coating for newly installed leadwork helping to prevent the carbonate staining that affects new lead and surrounding tiles, brickwork and stonework
- Helps to provide a uniform, attractive appearance to newly installed lead and helps the aging process whilst the natural patina of the lead is formed



Code	Size (litre)	Box Qty
LLPO050	0.5	10
LLPO100	1	10

## BITUMENS

### 901 BLACK BITUMEN PAINT

For metal protection and coating over wood and felt

### 903 BITUMEN TROWEL MASTIC

For sealing and filling holes in mastic asphalt and downpipes

### 904 ROOF FELT ADHESIVE

For bonding roofing felt to most surfaces

### 905 ALL WEATHER ROOF COATING

For general waterproofing in all roofing applications

### 907 SOLAR REFLECTIVE PAINT

For application over primed walls and roofs

### 908 D.P.M.

Provides a highly effective damp proof membrane for floors



Code	Description	Size (litre)	Box Qty
LBPA010	901 Black Bitumen Paint	1	1
LBPA025		2.5	1
LBPA050		5	1
LBPA250	903 Bitumen Trowel Mastic	25	1
LBTM010		1	1
LBTM025		2.5	1
LBTM050	5	1	
LBRA010	904 Bitumen Roof Felt Adhesive	1	1
LBRA025		2.5	1
LBRA050		5	1
LBRA250	25	1	
LAWC050	905 All Weather Roof Coating	5	1
LAWC250		25	1
LSVA050	907 Solar Reflective Paint	5	1
LDPM050	908 D.P.M.	5	1
LDPM250		25	1



### WELDED CHAIN

#### CORE USE

- Can be used for many applications such as securing equipment, mooring boats and as a moveable barrier

#### MATERIAL

- Light and strong steel
- Manufactured to DIN5685

SHORT LINK

LONG LINK



MAX. WORKING LOAD: a guide only, no certification is available

#### REEL

Code	Finish	Link Type	Link Size (mm)	Max. Recom. Working Load (kg)	Reel Length (m)
XQSWA30BZP	BZP	Short	3 x 16	40	30
XQSWA40BZP		Short	4 x 19	80	30
XQSWA50BZP		Short	5 x 21	125	30
XQSWA60BZP		Short	6 x 24	160	20
XQSWA70BZP		Short	7 x 28	220	15
XQSWA80BZP		Short	8 x 32	320	15
XQSWC30BZP		Long	3 x 26	40	30
XQSWC40BZP		Long	4 x 32	80	30
XQSWC50BZP		Long	5 x 35	125	30
XQSWC60BZP		Long	6 x 42	160	20
XQSWA40HDG	GALVANISED	Short	4 x 19	80	30
XQSWA50HDG		Short	5 x 21	125	30
XQSWA60HDG		Short	6 x 24	160	20
XQSWA70HDG		Short	7 x 28	220	15
XQSWA80HDG		Short	8 x 32	320	15
XQSWA98HDG		Short	10 x 40	350	10
XQSWC40HDG		Long	4 x 32	80	30
XQSWC50HDG		Long	5 x 35	125	30
XQSWC60HDG		Long	6 x 42	160	20
XQSWC70HDG		Long	7 x 49	220	15
XQSWC80HDG	Long	8 x 52	320	15	
XQSWC98HDG	Long	10 x 65	350	10	
XQSWA30BLK	BLACK PLATED	Short	3 x 16	40	30
XQSWA40BLK		Short	4 x 19	80	30

#### HANK

Code	Finish	Link Type	Link Size (mm)	Max. Recom. Working Load (kg)	Hank Length (m)
XQCA60BZP	BZP	Short	6 x 24	160	2
XQCA70BZP2		Short	7 x 28	220	2.5
XQCC25BZP		Long	2.5 x 24	30	2.5
XQCC60BZP		Long	6 x 42	160	2
XQCC40HDG	GALVANISED	Long	4 x 32	80	2
XQCC60HDG		Long	6 x 42	160	2
XQCC70HDG2		Long	7 x 49	220	2
XQCA25BLK		Short	2.5 x 14	30	2.5
XQCA50BLK	BLACK PLATED	Short	5 x 21	125	2
XQCA70BLK2		Short	7 x 28	220	2
XQCC60BLK2		Long	6 x 42	160	2

#### BOX

Code	Finish	Link Type	Link Size (mm)	Max. Recom. Working Load (kg)	Length (m)
XQBC50BLK	BLACK PLATED	Long	5 x 35	125	2

#### LINK SIZE

wire diameter x inside length

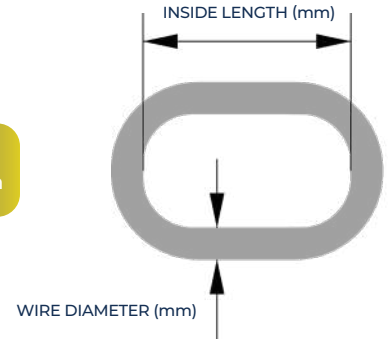

### SECURITY CHAIN

#### CORE USE

- Ideal for securing anything valuable around the home, garden, workshop or factory with a suitable padlock

#### MATERIAL

- BZP finish with blue PVC Sleeve
- Through hardened square section for maximum security
- Hacksaw and bolt cropper resistant



Code	Finish	Link Size (mm)	Reel Length (m)
XQQC08X0900	BZP with Blue PVC Sleeve	8	0.9
XQQC08X1200		8	1.2
XQQC10X1200		10	1.2
XQQC10X1500		10	1.5
XQQC10X2000		10	2.0

### PLASTIC CHAIN

#### CORE USE

- Can be used for a simple, but easily seen barriers across a private driveway or for perimeters and borders



Code	Finish	Link Size (mm)	Reel Length (m)
XQPC06RWR	RED/WHITE	6 x 50	3
XQPC06WER	WHITE	6 x 50	3

### OVAL CHAIN

#### CORE USE

- For light duty applications like suspending signs or for bathroom lights/toilet pulls



Code	Finish	Link Size (mm)	Max. Recom. Working Load (kg)	Reel Length (m)
XQAG017SCP	CHROME PLATED	1.5 x 12.5	11	20
XQAG020SCP		2.3 x 16.0	16	10
XQAG017SBP	BRASS PLATED	1.5 x 12.5	11	20
XQAG020SBP		2.3 x 16.0	16	10

## TWISTED CURB CHAIN

### CORE USE

- A decorative chain for general home applications
- A variety of uses including tying back curtains, key holders and dog leads



Code	Finish	Link Size (mm)	Max. Recom. Working Load (kg)	Reel Length (m)
XQFL10NP	NICKEL PLATED	1.0 x 7	0.5	50
XQFL12NP		1.2 x 8	1	25
XQFG20NP		2.0 x 14	5	15
XQFG24NP		2.4 x 15	10	10

## GENOVESE CHAIN

### CORE USE

- Useful for hanging lamps or flower pots, also can be used as a decorative suspension for signs



Code	Finish	Link Size (mm)	Max. Recom. Working Load (kg)	Reel Length (m)
XQL30NP	NICKEL PLATED	3 x 29	10	20
XQL30BP	BRASS PLATED	3 x 29	10	20

## SINGLE JACK CHAIN

### CORE USE

- Unwelded, economical and versatile chain
- Easily modified to hook, bend and adjust to exact sized lengths with no cutting



Code	Finish	Wire Diameter (mm)	Max. Recom. Working Load (kg)	Reel Length (m)
XQS20PG10	BZP	2.0	3.5	10

## DECORATIVE SQUARE CHAIN

### CORE USE

- Decorative chain with an individual style
- Useful for ornamental lighting, decorative ties and mirror chain



Code	Finish	Link Size (mm)	Max. Recom. Working Load (kg)	Reel Length (m)
XQLQ20BP	BRASS PLATED	2 x 17.6	10	40
XQLQ20BK	BLACK PLATED	2 x 17.6	10	40

## CLOCK CHAIN

### CORE USE

- Unwelded decorative domestic chain for general use, especially good for bathroom lights or toilet pulls



Code	Finish	Wire Diameter (mm)	Max. Recom. Working Load (kg)	Reel Length (m)
XQU14NP	NICKEL PLATED	1.4	5	25
XQU10BP	BRASS PLATED	1.1	2	50
XQU18BP		1.8	8	25

## KNOTTED CHAIN

### CORE USE

- The strongest unwelded chain for applications such as playground equipment, fluorescent lights, gates, tethering pets and livestock



Code	Finish	Link Size (mm)	Max. Recom. Working Load (kg)	Reel Length (m)
XQK27ZP	BZP	2.5 x 32	70	30

## CATHEDRAL CHAIN

Also known as "gothic chain".

### CORE USE

- Decorative chain in a gothic style that is used for ornamental lighting and suspension



Code	Finish	Link Size (mm)	Max. Recom. Working Load (kg)	Reel Length (m)
XQLVQ30AB	ANTIQUÉ BRASS	3 x 39	18	20

## BRASS BALL CHAIN

### CORE USE

- Decorative ball chain for general home applications
- Commonly used for blinds or sink and bath plugs



Code	Finish	Ball Diameter (mm)	Max. Recom. Working Load (kg)	Reel Length (m)
XQKK360CP	CHROME PLATED	3.6	3	50



## WIRE ROPE

### CORE USE

- Can be used with wire rope grips

### MATERIAL

- BZP wire rope made from individual steel wires



Code	Finish	Diameter (mm)	Max. Recom. Working Load (kg)	Reel Length (m)
XQWR30ST	BZP	3	90	200
XQWR50ST		5	240	100

## TWISTED POLYPROPYLENE ROPE

### MATERIAL

- A versatile general purpose rope made of twisted strands
- Resistant to most acids, oils and alkalis
- Floats and does not shrink when it gets wet

- STRONG
- ECONOMICAL



Code	Colour	Pack Type	Diameter (mm)	Max. Recom. Working Load (kg)	Reel/Coil Length (m)
XQPP04BE	BLUE	Reel	4	30	220
XQPP06BE		Reel	6	70	110
XQPP08BE		Reel	8	130	73
XQPP10BE		Reel	10	180	55
XQPP12BE		Reel	12	260	35
XQPP06BE30		Coil	6	70	30
XQPP08BE30		Coil	8	130	30
XQPP10BE30		Coil	10	180	30
XQPP12BE30		Coil	12	260	30
XQPP06BE220		Coil	6	70	220
XQPP08BE220		Coil	8	130	220
XQPP10BE220		Coil	10	180	220
XQPP12BE220	Coil	12	260	220	

## NYLON INTERWOVEN ROPE

### CORE USE

- Popular for camping

### MATERIAL

- Strong and long lasting rope that knots well
- Resistant to marine growth
- Does not absorb moisture

- LONG LASTING
- KNOTS WELL
- STRONG



Code	Colour	Diameter (mm)	Max. Recom. Working Load (kg)	Reel Length (m)
XQSNR10WE	WHITE	10	200	50

## ELASTIC ROPE

### CORE USE

- Used as a flexible tie down for luggage, camping, boats and transport
- Use with plastic coated hooks to make up individual requirements



Code	Colour	Diameter (mm)	Max. Recom. Working Load (kg)	Reel Length (m)
XQRT05WB	WHITE/BLACK	5	-	100
XQRT08WB		8	-	50

## WOVEN POLYPROPYLENE ROPE

### CORE USE

- Can be used with pulleys and winches

### MATERIAL

- Will hold its shape under tension or when cut

- ROT & MILDEW RESISTANT
- EASY TO TIE
- LOW STRETCH



Code	Colour	Pack Type	Diameter (mm)	Max. Recom. Working Load (kg)	Reel Length (m)
XQMFB03BE	BLUE	Reel	3	13	50
XQMFB03GN	GREEN	Reel	3	13	50
XQMFB03RD	RED	Reel	3	13	50
XQMFB03WE	WHITE	Reel	3	13	50
XQMFB03YW	YELLOW	Reel	3	13	50
XQMFB04BE	BLUE	Reel	4	30	50
XQMFB04GN	GREEN	Reel	4	30	50
XQMFB04RD	RED	Reel	4	30	50
XQMFB04WE	WHITE	Reel	4	30	50
XQMFB04YW	YELLOW	Reel	4	30	50

## POLYESTER YACHT ROPE

### CORE USE

- Withstands the constant demands of sailing

### MATERIAL

- Resistant to sunlight and chemicals
- Low moisture absorption

- HARDWEARING
- EASY TO GRIP
- LOW STRETCH



Code	Colour	Diameter (mm)	Max. Recom. Working Load (kg)	Reel Length (m)
XQBY08WG	GREEN/WHITE	8	125	100

## SISAL ROPE

### CORE USE

- General purpose rope made from natural fibre
- Ideal for garden use



Code	Colour	Diameter (mm)	Max. Recom. Working Load (kg)	Reel Length (m)
XQSL06NL	NATURAL	6	30	110
XQSL08NL		8	60	73

## HEMP ROPE

### MATERIAL

- Organic rope, made from natural fibre

- MOISTURE ABSORBENT
- PET FRIENDLY



Code	Colour	Diameter (mm)	Max. Recom. Working Load (kg)	Reel Length (m)
XQTH08NL	NATURAL	8	82	73
XQTH12NL		12	224	35

## CARBINE HOOKS

### CORE USE

- Used for connecting chain and rope
- Simple opening mechanism



Code	Finish	Size (mm)	Max. Recom. Working Load (kg)	Pack Qty
XDCHZ04040	BZP	4 x 40	25	10
XDCHZ05050		5 x 50	50	10
XDCHZ06060		6 x 60	65	10
XDCHZ07070		7 x 70	80	10
XDCHZ08080		8 x 80	100	10
XDCHZ09090		9 x 90	125	10
XDCHZ10100		10 x 100	150	10

## QUICK LINKS

### CORE USE

- Provides a fast ready connection for permanent or temporary applications



Code	Finish	Size (mm)	Max. Recom. Working Load (kg)	Pack Qty
XDQLZ04	BZP	4	30	10
XDQLZ05		5	70	10
XDQLZ06		6	80	10
XDQLZ07		7	90	5
XDQLZ08		8	100	5

## DEE SHACKLES

Also known as "chain shackle".

### CORE USE

- Often used as a connecting link for rope or chain



**SHACKLES**  
NARROW, SHAPED LIKE A LOOP OF CHAIN WITH A PIN CLOSURE

Code	Finish	Size (mm)	Max. Recom. Working Load (kg)	Pack Qty
XDDSZ005	BZP	5	40	20
XDDSZ006		6	50	20
XDDSZ008		8	100	20
XDDSZ010		10	160	20
XDDSZ011		11	200	20
XDDSZ012		12	260	20

## SPRING HOOKS

### CORE USE

- **Spring hook to crue:**  
Can be squeezed closed to form a permanent connection
- **Spring hooks to swivel:**  
Useful hooks for attaching small accessories

SPRING HOOK TO CRUE      SPRING HOOK TO SWIVEL



Code	Finish	Type	Size (mm)	Size	Pack Qty
XDSPCZ055	BZP	To Crue	55	2"	10
XDSPCZ060		To Crue	60	2 1/2"	10
XDSPCZ080		To Crue	80	3"	10
XDSPCZ090		To Crue	90	3 1/2"	10
XDSPCZ100		To Crue	100	4"	10
XDSPSZ055		To Swivel	55	2"	10
XDSPSZ060		To Swivel	60	2 1/2"	10
XDSPSZ080		To Swivel	80	3"	10
XDSPSZ090		To Swivel	90	3 1/2"	10
XDSPSZ100		To Swivel	100	4"	10

## WIRE ROPE GRIP

### CORE USE

- Used to grip the return end of wire or fibre rope when in a loop
- Quick and easy way to create a fixed loop



SUPPLIED WITH HEX NUTS

Code	Finish	For Rope Dia.		Pack Qty
		inch	mm	
XDRGZ03	BZP	1/8"	3	20
XDRGZ05		3/16"	5	20
XDRGZ06		1/4"	6	20
XDRGZ08		5/16"	8	20
XDRGZ10		3/8"	10	20
XDRGZ12		1/2"	13	20
XDRGZ16		5/8"	16	10
XDRGZ20		3/4"	20	10

## CORRUGATED FASTENERS

### CORE USE

- Used to make wood joints (e.g. picture frames), fasten parallel boards together (e.g. fastening table tops) or to substitute nails where they might split the timber

GROOVED PATTERN GIVES HIGH HOLDING POWER & DURABILITY



### MATERIAL

- Thin strip of metal with a sharp end along its length

### INSTALLATION

- Done by hand using a hammer

Code	Finish	Depth	No. of Corrugations	Pack Qty
XCFS40250	SELF COLOUR	1/4"	4	1000
XCFS40375		3/8"	4	1000
XCFS40500		1/2"	4	1000
XCFS40625		5/8"	4	1000
XCFS4075		3/4"	4	1000
XCFS41		1"	4	1000
XCFS5025		1/4"	5	1000
XCFS50375		3/8"	5	1000
XCFS505		1/2"	5	1000
XCFS50625		5/8"	5	1000
XCFS5075		3/4"	5	1000
XCFS51		1"	5	1000
XCFS6025		1/4"	6	1000
XCFS60375		3/8"	6	1000
XCFS605		1/2"	6	1000
XCFS60625		5/8"	6	1000
XCFS6075		3/4"	6	1000
XCFS61		1"	6	500

## METAL DOWELS

### CORE USE

- For strengthening timber joints
- Often used for window frames, furniture or wooden gate manufacture

ARROW HEAD ALLOWS THEM TO BE HAMMERED STRAIGHT INTO WOOD



### MATERIAL

- An alternative to wooden dowels, the Zamak metal construction offers additional strength and pullout

Code	Finish	Size (mm)	Pack Qty
XMDS19	SELF COLOUR	20	500
XMDS25		25	500
XMDS29		29	500
XMDS33		33	500
XMDS38		38	500
XMDS44		44	500
XMDS50		50	250
XMDS60		60	250

## CABLE TIES

### CORE USE

- Ideal for binding cables or components quickly
- Use black ties when secured in direct sunlight

### MATERIAL

- Manufactured from high quality virgin nylon 6.6



Code	Colour	Size (mm)	Max. Bundle Dia. (mm)	Pack Qty
XCTB025100	BLACK	2.5 x 100	18	100
XCTB025160		2.5 x 160	40	100
XCTB025200		2.5 x 200	50	100
XCTB036140		3.6 x 140	33	100
XCTB036200		3.6 x 200	50	100
XCTB036300		3.6 x 300	76	100
XCTB048160		4.8 x 160	38	100
XCTB048200		4.8 x 200	50	100
XCTB048250		4.8 x 250	63	100
XCTB048300		4.8 x 300	76	100
XCTB048370		4.8 x 370	102	100
XCTB048430		4.8 x 430	110	100
XCTB076370		7.6 x 370	100	100
XCTB090540		9.0 x 530	140	100
XCTN025100	NATURAL	2.5 x 100	18	100
XCTN025160		2.5 x 160	40	100
XCTN025200		2.5 x 200	50	100
XCTN036140		3.6 x 140	33	100
XCTN036200		3.6 x 200	50	100
XCTN036300		3.6 x 300	76	100
XCTN048160		4.8 x 160	38	100
XCTN048200		4.8 x 200	50	100
XCTN048250		4.8 x 250	63	100
XCTN048300		4.8 x 300	76	100
XCTN048370		4.8 x 370	102	100
XCTN048430		4.8 x 430	110	100
XCTN076370		7.6 x 370	100	100
XCTN090540		9.0 x 530	140	100

## SCREW EYES

### CORE USE

- Used for fixing into all types of timber and masonry walls
- Ideal for hanging mirror or paintings
- Widely used for fencing applications



Code	Finish	Overall Length (mm)	Screw Gauge (g)	Box Qty
XWEZ020	BZP	19	1.5	200
XWEZ023		23	2	200
XWEZ025		25	4	200
XWEZ030		30	6	200
XWEZ035		35	8	200
XWEZ040		40	8	200
XWEZ045		45	10	100
XWEZ055		55	12	100
XWEZ065		65	14	100
XWEZ075		75	18	50
XWEB012	ELECTRO BRASSED	12	00	500
XWEB014		14	1	500
XWEB017		17	1	500
XWEB019		19	1	200
XWEB025		25	4	200
XWEB030		30	6	200
XWEB035		35	8	200
XWEB040		40	8	200
XWEB045		45	10	100
XWEB055		55	12	100
XWEB065		65	14	100
XWEB075		75	18	50

## CUP HOOKS

### CORE USE

- General purpose plain household hooks that can be screwed into place without the need of a pilot hole



Code	Finish	Overall Length (mm)	Screw Gauge (mm)	Box Qty
XWCZ020	BZP	19	1.5	200
XWCZ023		23	1.5	200
XWCZ040		40	3.2	100
XWCB025	ELECTRO BRASSED	25	2.3	100
XWCB040		40	3.2	100
XWCB050		50	3.3	100

## M HOOKS

### CORE USE

- Can be used for a variety of applications where more strength is required (e.g. hanging chain on wooden posts, garden furniture, trellis systems, etc.)



Code	Finish	Overall Length (mm)	Screw Gauge (g)	Box Qty
XWMZ055	BZP	55	8	100
XWMZ060		60	10	100
XWMZ080		80	12	50
XWMZ100	ELECTRO BRASSED	100	18	50
XWMB055		55	8	100
XWMB060		60	10	100
XWMB080		80	12	50
XWMB100	100	18	50	

## GATE HOOKS & EYES

### CORE USE

- Used for holding light gates, doors and shutters in place which makes them ideal for use on rabbit hutches



Code	Finish	Overall Length (mm)	Box Qty
XWGZ050	BZP	50	100
XWGZ075		75	100
XWGZ100		100	100

## VINE EYES TO DRIVE

### CORE USE

- For securing vines and plants to walls

HOLED TO CARRY A WIRE



Code	Finish	Length (mm)	Box Qty
XWDZ075	BZP	75	100
XWDZ100		100	100

## VINE EYES TO SCREW

### CORE USE

- Can be used to carry a wire for training plants



Code	Finish	Length (mm)	Gauge (g)	Box Qty
XWVZ075	BZP	75	12	100
XWVZ100		100	12	100



## JUBILEE CLIPS

### CORE USE

- Suited for most day-to-day requirements for joining hose in areas such as the automotive industry, also in agricultural, pneumatic and hydraulic applications

### MATERIAL

- Only premium grade materials



**MANUFACTURED TO**  
BS 5315:1991

**NEUTRAL SALT SPRAY TESTED TO**  
BS EN ISO 9227 2006

**THREADED BAND**  
ENABLES EXTRA FLEXIBILITY WHEN ADJUSTING SIZE

**SMOOTH INSIDE PROFILE & ROLLED EDGES**  
GIVE PROTECTION FOR ALL TYPES OF HOSES

Code	Finish	Size	Adjustment (mm)	Box Qty
XJCS001	BZP MILD STEEL	000	9.5-12	10
XJCS002		M00	11-16	10
XJCS003		00	13-20	10
XJCS004		0	16-22	10
XJCS005		0X	18-25	10
XJCS006		1A	22-30	10
XJCS007		1	25-35	10
XJCS008		1X	30-40	10
XJCS008A		1M	32-45	10
XJCS009		2A	35-50	10
XJCS010		2	40-55	10
XJCS011		2X	45-60	10
XJCS012		3	55-70	10
XJCS013		3X	60-80	1
XJCS014		4	70-90	1
XJCS015		4X	85-100	1
XJCS016		5	90-120	1
XJCS018		6	110-140	1
XJCS020		7	135-165	1
XJCS022		7.5	158-190	1
XJCST001	A2 STAINLESS STEEL	000	9.5-12	10
XJCST002		M00	11-16	10
XJCST003		00	13-20	10
XJCST004		0	16-22	10
XJCST005		0X	18-25	10
XJCST006		1A	22-30	10
XJCST006A		1	25-35	10
XJCST007		1X	30-40	10
XJCST007A		1M	32-45	10
XJCST008		2A	35-50	10
XJCST011		2	40-55	10
XJCST012		2X	45-60	10
XJCST013		3	55-70	10
XJCST014		3X	60-80	1
XJCST015		4	70-90	1
XJCST016		4X	85-100	1

## JUBILEE CLIP FLEXIDRIVER & DISPENSER

- **Flexidriver:**  
Designed for Jubilee Clips, its flexible shaft enables tightening in inaccessible areas
- **CD100 counter top clip dispenser:**  
Eye-catching and functional, designed to improve stock turn



Code	Description	Box Qty
XJCSFLEX	Flexidriver 7mm A/F socket head	1
XJCSCD1003D	Supplied complete with 10 of each BZP size from 000 to 2 and 3 x Flexidrivers	1



## UNBREAKABLE PENCILS

### UNBREAKABLE PENCIL

#### MATERIAL

- Woodless
- Made from a revolutionary graphite composite material
- Rarely ever needs sharpening
- Water and rain resistant





Code	Size (mm)	Box Qty
XTPENCIL	182 x 15	12





PROVIDED IN EUROSLOTTED BAGS  
JOHN GEORGE BRANDED  
AVAILABLE OFF THE SHELF  
EASILY SALEABLE PACK SIZES  
SOLD IN OUTERS





## WIRE ROPE GRIPS

	Finish	Rope Diameter (mm)	
			Outer Qty 5 BAG Qty
X7QWGZ03	BZP	3	4no
X7QWGZ05		5	4no
X7QWGZ08		8	2no
X7QWGZ10		10	2no



## CARBINE HOOKS

	Finish	Size (mm)	
			Outer Qty 5 BAG Qty
X7QCHZ05050	BZP	5 x 50	3no
X7QCHZ07070		7 x 70	1no



## DEE SHACKLES

	Finish	Size (mm)	
			Outer Qty 5 BAG Qty
X7QDSZ05	BZP	5	2no
X7QDSZ08		8	2no
X7QDSZ10		10	1no
X7QDSZ12		12	1no



## THIMBLES

	Finish	Size (mm)	
			Outer Qty 5 BAG Qty
X7QRTZ04	BZP	4	2no
X7QRTZ06		6	2no
X7QRTZ08		8	2no
X7QRTZ10		10	1no
X7QRTZ12		12	1no



## MEAT HOOKS

	Finish	
		Outer Qty 5 BAG Qty
X7QMZH	BZP	2no



## QUICK LINKS

	Finish	Size (mm)	
			Outer Qty 5 BAG Qty
XDQLZ04	BZP	4	4no
XDQLZ06		6	2no
XDQLZ08		8	2no



## MENDING LINKS

	Finish	Size (mm)	
			Outer Qty 5 BAG Qty
X7QMLZ04	BZP	4	4no
X7QMLZ06		6	3no



## TRIGGER HOOKS

	Finish	Size (mm)	
			Outer Qty 5 BAG Qty
X7QTHZ06060	BZP	6 x 60	1no

## STRAINING SCREWS



	Finish	Size (mm)	
			Outer Qty 5 BAG Qty
X7QSSZ06	BZP	6	2no
X7QSSZ08		8	1no
X7QSSZ10		10	1no



## JUBILEE CLIPS



	Finish	Size	Adjustment (mm)	
				Outer Qty 1 BAG Qty
X7JCS001	BZP MILD STEEL	000	9.5-12	2no
X7JCS002		M00	11-16	2no
X7JCS003		00	13-20	2no
X7JCS004		0	16-22	2no
X7JCS005		0X	18-25	2no
X7JCS006		1A	22-30	2no
X7JCS007		1	25-35	2no
X7JCS008		1X	30-40	2no
X7JCS009		2A	35-50	2no
X7JCS010		2	40-55	2no
X7JCS012		2X	45-60	2no
X7JCS014		4	70-90	2no
X7JCS016		5	90-120	2no



## PREPACKED HOOKS & EYES IN SMALL HANGING CLAMS



**JOHN GEORGE BRANDED HOOKS & EYES PROVIDED IN CLEAR EUROSLOTTED CLAMS AVAILABLE OFF THE SHELF IDEAL FOR SMALL JOBS & DIY SOLD IN OUTERS**



CUP HOOKS				
	Finish	Size (mm)	Gauge (mm)	
				Outer Qty 10
				CLAMPAQ Qty
X6WCZ023	BZP	23	1.5	10no
X6WCZ040		40	3.2	5no
X6WCB025	ELECTRO BRASSED	25	2.3	8no
X6WCB040		40	3.2	4no

GATE HOOKS & EYES			
	Finish	Overall Length (mm)	
			Outer Qty 10
			CLAMPAQ Qty
X6WCZ050	BZP	50	5no
X6WGW075		75	3no
X6WGW100		100	2no

M HOOKS				
	Finish	Overall Length (mm)	Gauge (g)	
				Outer Qty 10
				CLAMPAQ Qty
X6WMZ060	BZP	60	10	5no
X6WMZ080		80	12	3no

VINE EYES TO DRIVE			
	Finish	Length (mm)	
			Outer Qty 10
			CLAMPAQ Qty
X6WDZ075	BZP	75	3no
X6WDZ100		100	2no

SCREW EYES				
	Finish	Overall Length (mm)	Gauge (g)	
				Outer Qty 10
				CLAMPAQ Qty
X6WEZ030	BZP	30	6	12no
X6WEZ040		40	8	10no
X6WEZ045		45	10	8no
X6WEZ055		55	12	5no
X6WEZ075		75	18	2no

VINE EYES TO SCREW			
	Finish	Overall Length (mm)	
			Outer Qty 10
			CLAMPAQ Qty
X6WVZ075	BZP	75	3no
X6WVZ100		100	2no

